

high fidelity

APRIL

THE MAGAZINE FOR MUSIC LISTENERS

60 CENTS

1961

Tenth  
Anniversary  
Issue

RCA VICTOR RECORDS ANNOUNCES

# THE GREATEST SALE ON EARTH

LATEST POP RELEASES



LATEST CLASSICAL RELEASES



ORIGINAL CAST & SOUND TRACKS

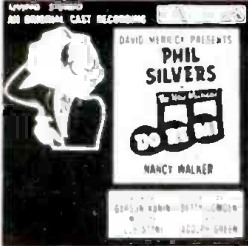

**ANY ALBUM AT HALF PRICE**  
 WHEN YOU BUY ONE IN SAME PRICE RANGE AT REGULAR PRICE\*

**CHOOSE**  
 FROM THE ENTIRE CATALOG OF THE WORLD'S GREATEST ARTISTS

Spectacular as The Greatest Show on Earth  
 Ringling Bros. and Barnum & Bailey

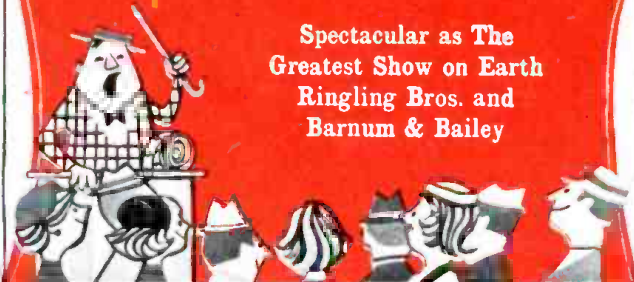

STEREO SPECTACULARS

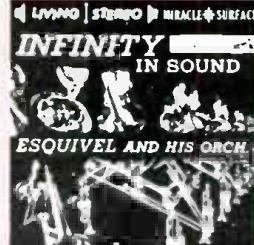
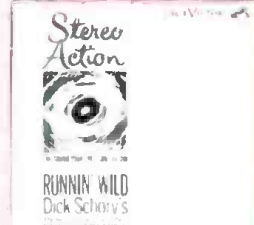

BEST SELLERS



ALL-TIME FAVORITES



**ACT NOW—LIMITED TIME ONLY!**  
 Available at all participating dealers who display this sign



\*Based on Mfr.'s Nationally Advertised Prices — Optional with Dealer



**RCA VICTOR**  
 RADIO CORPORATION OF AMERICA



# this is the empire<sup>®</sup> troubador

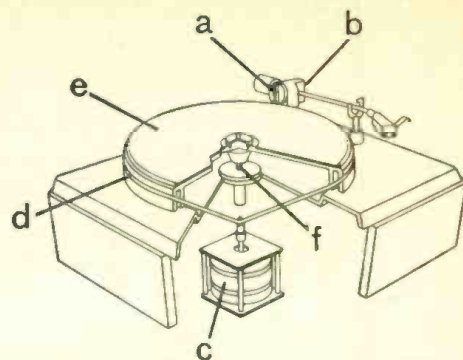

## the playback unit that enables you to enjoy all the quality of today's records

With the tremendous advances achieved in record quality, and in amplifier and speaker components, the playback unit assumes a role of unprecedented importance. It is the vital link between the record's promise of performance and its ultimate realization. For, if all the quality in the modern record were extracted from its grooves, and delivered—unaltered—to the amplifier, the result would be almost indistinguishable from the original live performance.

No one playback component can fulfill this requirement. It takes all three. And that is why you can depend upon the Troubador—combining the finest cartridge, arm and turntable—to deliver all the quality in your records to the rest of your music system.

### empire 108 mono-stereo cartridge

Low mass and high compliance. Stylus tracks with force as low as 1 gram. Flat from 10 to 20,000 cycles on both channels, balance to  $\pm 1/4$  db. Full channel separation over entire spectrum. \$34.50

### empire 98 playback arm

Dynamic balance, low inertia and high compliance make the 98 the most stable yet freely responsive arm available. Tracks 108 cartridge at 1 gram. \$37.50

ARM NOTES: (a) Calibrated knob—accurate to  $\pm 0.1$  gram—adjusts torque of clock spring for desired stylus force without disturbing arm balance—does not shift center-of-mass. (b) Vertical and lateral pivot bearings suspended in ball races.

### empire 208 3-speed turntable

Only two moving parts—motor and turntable—coupled by seamless belt for lowest rumble content. Vertical and horizontal rumble amplitude, less than 1 millionth of an inch. No wow or flutter. \$92.50

TURNTABLE NOTES: (c) Hysteresis motor has dynamically balanced rotor and stepped, 3-speed pulley. (d) Neoprene-impregnated seamless belt is ground to uniform thickness  $\pm .0005$ ". (e) Turntable platter individually adjusted to dynamic balance. Weighs 6 lbs., and has dual rim for optimum flywheel effectiveness. (f) Lapped mainshaft rotates in micro-honed bearing-well. Tolerance is less than .0001".

See and hear the Troubador at your high fidelity dealer today and discover the wonderful difference it will make in the performance of your music system. Price is \$180, including cartridge, arm, turntable and walnut base. Price, less cartridge, is \$145.50. For descriptive literature, write to:

**empire**  
DYNEMPIRE INC. 1075 STEWART AVE.  
GARDEN CITY, N. Y.

CIRCLE 15 ON READER-SERVICE CARD

# Exclusive Assurance of Quality

*Only the Stanton Fluxvalve can provide the exclusive and patented features which make it the finest pickup available.*

The significance of a document . . . a LETTERS PATENT conferring *exclusive* rights and privileges on an individual to manufacture and vend an invention both *new* and *useful* . . . further signifies a most important responsibility upon that individual.

Endowed with this responsibility, PICKERING & COMPANY pioneered—through their outstanding participation in stereophonic development—the STANTON STEREO FLUXVALVE, the very first (and only) stereo cartridge incorporating the revolutionary T-GUARD stylus.

But this was only the beginning—through continued development—major advances in stereo pickup design were brought about by the use of PICKERING & COMPANY's long experience . . . special skills and exclusive techniques.

Thus; less than one year after the introduction of the stereo record, PICKERING & COMPANY introduced the MODEL 380 STANTON STEREO FLUXVALVE. And, in a few short months, the 380 earned its reputation from the experts as — "The finest stereo pickup ever tested".

*Isn't it time you found the true answer to stereo as it was meant to be?*

WE urge you to go to your dealer for a 380 FLUXVALVE DEMONSTRATION—we know you will find its quality of performance almost beyond belief.

FOR THOSE WHO CAN HEAR THE DIFFERENCE



for more than a decade—the world's most experienced manufacturer of high fidelity pickups . . . supplier to the recording industry.

PICKERING & CO., INC., PLAINVIEW, NEW YORK

The Stanton Fluxvalve and Stereo Fluxvalve are patented (and patents are pending) in the United States, Great Britain, Canada, Japan and other countries throughout the world.

TO WHOM THESE PRESENT

Walter O. Stanton

of

ALLEGED NEW A  
CONTAINED IN T  
ND MADE A PART BE  
IN SUCH CASES N

MINATION MADE THE S  
TLED TO A PATENT UNDI

Letters Patent

on, his heirs

SEVENTEEN YEARS FROM THE S

EXCLUDE OTHERS FROM MAKING, USING  
ABOUT THE UNITED STATES.

In testimony where  
hand and caused the  
to be affixed at the  
this fifteenth  
the year of our  
and fi  
vidence of the  
the one hundred and

Attest:  
Paul H. Johnson  
Attesting Officer.

Collector's Series  
STANTON Stereo FLUXVALVE  
Model 380A  
for use in  
transcription  
stereo  
gram

PICKERING & C

TYPE OF USE:  
 Professional  
 Home

**Roland Gelatt**  
Editor  
**Joan Griffiths**  
Executive Editor  
**Norman Eisenberg**  
Audio Editor  
**Conrad L. Osborne**  
Managing Editor  
**Shirley Fleming**  
Assistant Editor  
**Roy Lindstrom**  
Art Director  
**H. C. Robbins Landon**  
European Editor

**Ralph Freas**  
Audio Coordinator

*Editorial Board*

**John M. Conly**  
Chairman  
**E. Power Biggs**  
**Nathan Broder**  
**R. D. Darrell**  
**Alfred Frankenstein**  
**Howard Hanson**  
**Julian Hirsch**  
**Robert C. Marsh**  
**Francis Robinson**  
**Joseph Szigeti**

**Warren B. Syer**  
General Manager  
**Claire N. Eddings**  
Advertising Sales Manager  
**Walter F. Grueninger**  
Circulation Director

*Publication Policy*

**Charles Fowler**  
**Lawrence Gatto**  
**W. D. Littleford**  
**Warren B. Syer**

**A D V E R T I S I N G**

**Main Office**  
Claire N. Eddings, The Publishing House  
Great Barrington, Mass. Telephone 1300

**New York**  
1564 Broadway, New York 36  
Telephone: Plaza 7-2800  
Seymour Resnick, Andrew Spanberger

**Chicago**  
10 East Huron St., Chicago 11  
Telephone: Michigan 2-4245  
Peter Dempers, Thomas Berry,  
Allen Campbell

**Los Angeles**  
1520 North Cower, Hollywood 28  
Telephone: Hollywood 9-6239  
George Kelley

Ten Years of High Fidelity	<b>38</b>	<i>Roland Gelatt</i>
The Claude Hummel Diary	<b>41</b>	<i>Martin Mayer</i>
Conversations with Stokowski	<b>44</b>	<i>Robert C. Marsh</i>
FM's Next Chapter	<b>48</b>	<i>Norman Eisenberg</i>
Confessions of an Ex-Claqueur	<b>52</b>	<i>Joseph Wechsberg</i>
Gettysburg in Stereo	<b>56</b>	<i>Shirley Fleming</i>
Out, Out, Damned Knob	<b>60</b>	<i>Charles Fowler</i>
The Barons of Bayreuth	<b>63</b>	<i>Paul Moor</i>
The Shape of Sound to Come	<b>66</b>	<i>Robert Silverberg</i>
The Jazz Dilemma	<b>69</b>	<i>John S. Wilson</i>
Great Recordings of the Decade	<b>72</b>	

**EQUIPMENT**

FM Antennas: How To Get the Best From Your Tuner	<b>150</b>	<i>Charles S. Tepfer</i>
Equipment Reports	<b>81</b>	
High Fidelity Newsfronts	<b>147</b>	<i>Ralph Freas</i>

**REVIEWS**

Feature Record Review—Wagner: "Tristan und Isolde"	<b>89</b>
Other Classical Record Reviews	<b>92</b>
The Lighter Side	<b>126</b>
Jazz Record Reviews	<b>135</b>
The Tape Deck	<b>139</b>

# LAFAYETTE RADIO

## KT-600A PROFESSIONAL STEREO CONTROL CENTER

KT-600A In Kit Form **79.50** LA-600A Completely Wired **134.50**  
5.00 DOWN

- Response 5-40,000 cps  $\pm$  1 db.
- Precise "Null" Balancing System
- Unique Stereo and Monaural Control Features
- Concentric Input Level Controls
- Easy-To-Assemble Kit Form.

Sensitivity 2.2 mv for 1 volt out. Dual low impedance "plate follower" outputs 1500 ohms. Less than .03% IM distortion; less than .1% harmonic distortion. Hum and noise 80 db below 2 volts. 14x10 $\frac{1}{2}$ x4 $\frac{1}{2}$ ". Shpg. wt., 16 lbs.

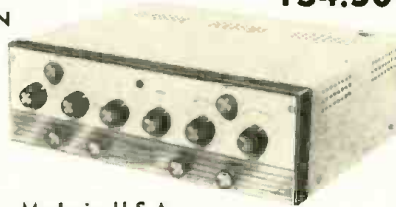

Made in U.S.A.

## THE REMARKABLE KT-650 FM TUNER KIT

KT-650 Kit **54.50** LT-650A Completely Wired **79.95**  
5.00 Down



Made in U.S.A.

- Virtually Distortionless Performance—Less Than .15% Distortion at 100% Modulation
- Sensitivity 3  $\mu$ v for 30db of Quieting
- Response  $\pm$  1/2db 15-35,000 cps
- Variable AFC

Professional FM Laboratory Standard Performance — Circuitry employs a low noise front end with triode mixer plus double tuned dual limiter and wide band Foster Seeley discriminator. IF and Discriminator coils are factory prealigned—permits playing the tuner as soon as assembly is completed. Printed circuit board and famous Lafayette Instruction manuals make kit building a pleasure. 14x $\frac{1}{2}$ Hx11"D. Shpg. wt., 13 $\frac{1}{2}$  lbs.

## NEW! KT-550 100-WATT BASIC STEREO AMPLIFIER KIT

KT-550 In Kit Form **134.50** LA-550 Completely Wired **184.50**  
5.00 Down

- Rated at 50-Watts per Channel
- Response from 2-100,000 cps, 0, -1db at 1-Watt
- Grain Oriented, Silicon Steel Transformers
- Multiple Feedback Loop Design
- Easy-To-Assemble Kit Form

A new "Laboratory Standard" dual 50-watt amplifier guaranteed to outperform any basic stereo amplifier on the market. Advanced engineering techniques plus the finest components ensure flawless performance. Distortion levels so low they are unmeasurable. Hum and noise better than 90 db below 50-watts. Complete with metal enclosure. 9 $\frac{1}{4}$ x12 $\frac{1}{2}$ "D. Shpg. wt., 60 lbs.



Made in U.S.A.

## KT-500A FM-AM STEREO TUNER KIT

KT-500A In Kit Form **74.50** LT-50A Completely Wired **124.50**  
5.00 Down

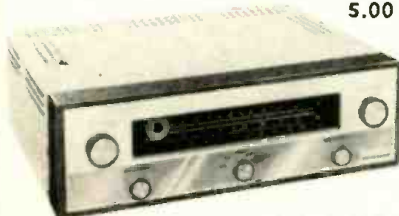

Made in U.S.A.

- Multiplex Output for New Stereo FM
- Armstrong Circuit with Dual Limiters and Foster-Seeley Discriminator
- Extreme Sensitivity and Wide Frequency Response
- Easy-To-Assemble Kit Form

Separate FM and AM tuning sections, each with its magic eye. FM: automatic frequency control, 2 microvolts sensitivity for 30 db quieting, frequency response 20-20,000 cps  $\pm$  1/2 db, full 200 kc bandwidth. AM: efficient broadband circuitry, built-in antenna. Two printed circuit boards make wiring simple. 13 $\frac{3}{4}$ x10 $\frac{1}{4}$ x4 $\frac{1}{2}$ ". Shpg. wt., 22 lbs.

## AUTHORitatively Speaking

With this issue, we celebrate our tenth anniversary, and in honor of the occasion we have gathered together some old acquaintances—earliest among them being Charles Fowler, former editor and former publisher of this magazine. Mr. Fowler, in fact, brought us into being, and has never really managed to get us off his hands. He refuses to play paterfamilias, but he will, sometimes, yield to our requests for contributions. This month our importunities have earned us "Out, Out Damned Knob" (p. 60); we hope they will continue to bring us the same kind of genial audio wisdom.

It's the future, of course, we're thinking about, but we do feel we should be permitted a small retrospective glance. It was back in the spring of 1953, for instance, that we acquired our jazz authority, John S. Wilson. Every month since, Mr. Wilson has reviewed the current crop of jazz discs, and has practically converted us to the ranks of aficionados. In any case, when he takes a stand on "The Jazz Dilemma" (p. 69), we know that he writes with both the intimacy and the perspective acquired by long exposure.

Our editor, Roland Gelatt, made his debut in these pages in the fall of 1953 with "The Sun Never Sets on EMI"—a report on the British headquarters of Electric & Musical Industries Ltd., which he had visited a few months earlier. In those far-off days he was busily employed as Feature Editor of *Saturday Review*. A year later, as soon as he had put the finishing touches on his book *The Fabulous Phonograph*, Mr. G. was persuaded to link his career with ours. For the Editor's views on "Ten Years of High Fidelity," see p. 38.

Martin Mayer first appeared in our publication in September 1954 with an article on a rising young diva named Maria Meneghini Callas. "AUTHORitatively Speaking" said at the time that Mr. Mayer was an editor of *Esquire*, traveling in Europe and working on a book about Wall Street. Mr. Mayer duly covered Wall Street and then, as all the world knows, did the same for Madison Avenue. Most recently he has turned his attention to education. The result is *The Schools*, published this month by Harper & Bros. For his latest contribution to HIGH FIDELITY, see "The Claude Hummel Diary," p. 41.

At about the same time Mr. Mayer entered our lives, so too did Robert C. Marsh, whose Toscanini discography we published in December 1954. Mr. Marsh was then just completing his book on *Toscanini and the Art of Orchestral Performance*. It is clear that the same subject still engrosses his attention, as witness "Conversations with Stokowski" (p. 44). R.C.M. is so much the dedicated scholar that we rather feared for his future, until the gala day when he took unto himself a bride and we had the privilege of giving her away.

However, no sufferers from nostalgia, we! We welcome to our anniversary pages with equal zest our newer friends Joseph Wechsberg, Paul Moor, and Robert Silverberg; and we have a full appreciation of the midnight oil which Shirley Fleming and Norman Eisenberg of our own staff expended on our behalf. For once this column will abjure its usual becoming modesty and say we think the party's good.

**FREE!** The NEW 1961 Lafayette Electronics Catalog No. 610

Lafayette Radio, Dept. WD1-1 P.O. Box 190, Jamaica 31, N. Y.

Name \_\_\_\_\_

Address \_\_\_\_\_

City \_\_\_\_\_ Zone \_\_\_\_\_ State \_\_\_\_\_

**LAFAYETTE  
RADIO**  
LOCATIONS ▶ JAMAICA 33, NEW YORK

NEW YORK 13, N.Y.

BRONX 58, N.Y.

NEWARK 2, N.J.

PLAINFIELD, N.J.

PARAMUS, N.J.

BOSTON 10, MASS

CIRCLE 71 ON READER-SERVICE CARD



# In a short trial subscription to the RCA VICTOR METROPOLITAN OPERA RECORD CLUB

YOU CAN OBTAIN

## Any one of these complete operas

REGULAR RETAIL PRICES UP TO \$14.98

### WITHOUT CHARGE

IF YOU JOIN NOW AND AGREE TO BUY FOUR OPERA ALBUMS WITHIN THE NEXT YEAR—CHOOSING THEM FROM THE CLUB'S MONTHLY OFFERINGS

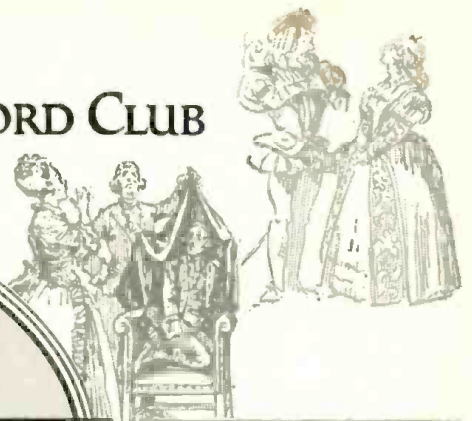

**A FOUR-RECORD ALBUM**

807. THE MARRIAGE OF FIGARO—Tozzi, Peters, Della Casa, London, Elias, Corena; Erich Leinsdorf, conductor (List price \$14.98)



**A TWO-RECORD ALBUM**

801. LA BOHÈME—De los Angeles, Bjoerling, Merrill, Amara, Tozzi; Sir Thomas Beecham, Bart., C.H., conductor (List price \$9.98)



**A THREE-RECORD ALBUM**

800. LA TRAVIATA—Carteri, Valletti, Warren; Pierre Monteux, conductor (List price \$9.98)



**A THREE-RECORD ALBUM**

804. CARMEN—Stevens, Peerce, Albanese, Merrill; Fritz Reiner, conductor (List price \$9.98)



**A THREE-RECORD ALBUM**

805. AIDA—Milanov, Bjoerling, Warren, Barbieri; Jonel Perlea, conductor (List price \$9.98)



**A TWO-RECORD ALBUM**

803. CAVALLERIA RUSTICANA—Tebaldi, Bjoerling, Bastianini, Alberto Erede, conductor (List price \$9.98)

THE exciting ultimate objective is to make available a comprehensive library of grand opera similar to the collections of the world's great books to be found in the best homes. The complete "living" repertory of opera — Italian, German, French, Russian, American — will in time be provided. Each member can choose as few as four opera albums a year.

\* In addition to recordings of Metropolitan productions, operas recorded abroad by RCA VICTOR will be made available to members, with Metropolitan artists in the cast. In virtually every case, operas will be available in complete form.

\* As a member you will enjoy a GREAT SAVING compared with what you would pay for the same records if you bought them separately and haphazardly as a non-member at the manufacturer's

nationally advertised price. For, with each additional shipment after the trial period, members receive, automatically, Record-Dividend Certificates worth 50% of the purchase price. As an example, if you choose to purchase a complete opera album for \$9.98, you will receive Dividend Certificates which will entitle you to select—without charge—any one of the wide variety of \$4.98 RCA VICTOR Red Seal records listed in the Club's Dividend Catalog.

\* Albums are sold to members at the nationally advertised price of all RCA VICTOR Red Seal opera records, which is currently (except for de luxe albums) \$4.98 for a single-record album, \$9.98 for a two- or three-record album and \$14.98 for a four-record album (plus a small charge for postage and handling, with use/sales tax where required).

**CHOOSE YOUR FAVORITE SINGERS IN THEIR MOST FAMOUS ROLES**

ALBANESE	DELLA CASA	HINES	NILSSON	STEBER	TOZZI
AMARA	DEL MONACO	JURINAC	PEERCE	STEVENS	VALLETTI
BASTIANINI	DE LOS ANGELES	LONDON	PETERS	TEBALDI	VICKERS
BERGONZI	DI STEFANO	MERRILL	PRICE	TUCKER	WARREN
BJOERLING	ELIAS	MILANOV	RYSANEK	A LIBRETTO INCLUDED WITH EACH OPERA	
CORENA	GEDDA	MOFFO	SIEPI		

The RCA VICTOR Metropolitan Opera Record Club  
P.O. Box No. 3, Village Station,  
New York 14, N. Y.

INDICATE BY NUMBER IN BOX BELOW THE COMPLETE OPERA YOU WANT

Please enroll me as a member of THE RCA VICTOR METROPOLITAN OPERA RECORD CLUB and send me a recording of the complete opera indicated at right, without charge. I agree to buy four opera albums within the next twelve months which I will choose from the Club's monthly offerings and for each of which I will be billed at the nationally advertised price (plus a small charge for postage and handling, with use/sales tax where required). I may cancel my membership any time after buying four albums from the Club. If I continue, for every shipment I receive from the Club I will be given Record-Dividend Certificates worth 50% of the purchase price. If I wish to, however, I may cancel this trial membership within ten days, in which case I will return the free album.

MR. }  
MRS. }  
MISS }

Address.....

City.....

Zone.....

State.....

PLEASE NOTE: Records can be shipped only to residents of the U. S. and its territories and Canada. Records for Canadian members are made in Canada and shipped duty free from Ontario.

CIRCLE 26 ON READER-SERVICE CARD

JOHN BROOK

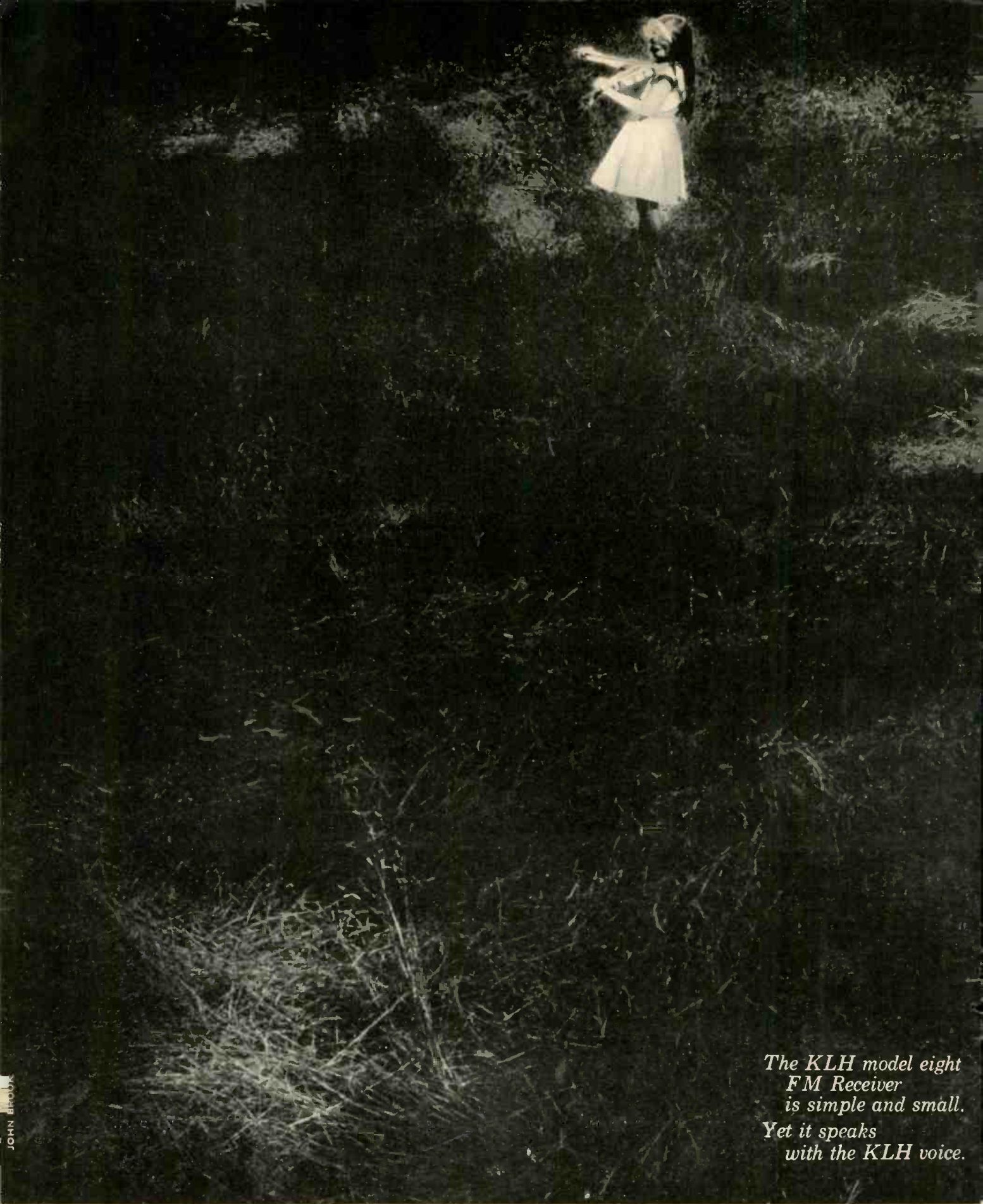

*The KLH model eight  
FM Receiver  
is simple and small.  
Yet it speaks  
with the KLH voice.*

CIRCLE 67 ON READER-SERVICE CARD



KLH RESEARCH AND DEVELOPMENT CORPORATION  
30 CROSS STREET, CAMBRIDGE 38, MASSACHUSETTS

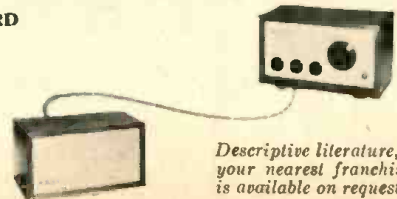

*Descriptive literature, with the name of  
your nearest franchised KLH dealer,  
is available on request.*

[www.americanradiohistory.com](http://www.americanradiohistory.com)



# Are any of these incomparable multi-record sets missing from your record library? [NOTE: THEIR NATIONALLY ADVERTISED PRICES RANGE FROM \$21.98 UP TO \$41.98]

## A SEVEN-RECORD SET

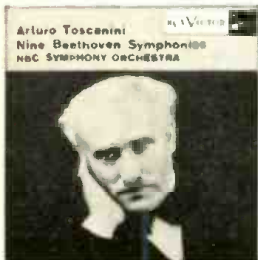

**507. THE NINE BEETHOVEN SYMPHONIES.** NBC Symphony Orchestra, Arturo Toscanini, conductor

Regular L.P. \$34.98  
NOT AVAILABLE IN STEREO

## THE RCA VICTOR SOCIETY OF GREAT MUSIC

OFFERS YOU . . . IN A SHORT TRIAL MEMBERSHIP

# ANY SET FOR \$4.98

AVAILABLE IN STEREO UNLESS OTHERWISE INDICATED

IF YOU WILL AGREE TO BUY SIX ADDITIONAL 12-INCH DISCS DURING THE NEXT YEAR

## A SEVEN-RECORD SET

**508. EIGHT GREAT SYMPHONIES.** Boston Symphony. Beethoven: *Eroica*; Mendelssohn: *Italian & Reformation*; Brahms: Nos. 1 & 4; Franck: D minor—Munch, conductor • Tchaikovsky: No. 5 & *Pathétique*—Monteux, conductor

Regular L.P. \$34.98  
Stereo \$41.98



**504. BACH'S WELL-TEMPERED CLAVIER—Complete.** "The Mighty Forty-Eight" performed on the harpsichord by Wanda Landowska

Regular L.P. \$29.98  
NOT AVAILABLE IN STEREO



## A FOUR-RECORD SET

**501. VIENNA PHILHARMONIC FESTIVAL.** Von Karajan, conductor. Mozart: Symphony No. 40; Haydn: Symphony No. 104; Beethoven: Symphony No. 7; Brahms: Symphony No. 1; works by Johann Strauss, Jr. *De Luxe Soria Set*

Regular L.P. \$21.98  
Stereo \$25.98



## A FOUR-RECORD SET



**502. HANDEL'S MESSIAH—Complete.** Soloists: Vyvyan, Sinclair, Vickers, Tozzi. Sir Thomas Beecham, Bart., C.H., conductor  
*De Luxe Soria Set*

Regular L.P. \$21.98  
Stereo \$25.98

## A SIX-RECORD SET



**506. TCHAIKOVSKY OMNIBUS.** Piano & Violin concertos; Symphony No. 5 & *Pathétique*; *Nutcracker* & *Sleeping Beauty* excerpts; *Capriccio Italien*. Cliburn, Heifetz, Kondrashin, Monteux, Reiner

Regular L.P. \$29.98  
Stereo \$35.98

## A SIX-RECORD SET



**505. RUBINSTEIN PLAYS CHOPIN.** 69 Selections: Polonaises, Waltzes, Nocturnes and the complete Impromptus and Preludes

Regular L.P. \$29.98  
NOT AVAILABLE IN STEREO

## THE BASIC IDEA: SYSTEMATIC COLLECTION UNDER GUIDANCE

MOST MUSIC-LOVERS certainly intend to build up a truly representative record library, but, unfortunately, almost always they are haphazard in carrying out this aspiration. Systematic collection not only means that they will ultimately build up a record library of which they can be proud, but that they can do so at an IMMENSE SAVING.

The one-year membership offer made here is a dramatic demonstration. In the first year it can represent a saving of AS MUCH AS 40% over the manufacturer's nationally advertised prices.

After purchasing the six additional records called for in this trial membership, members who continue can build up their record libraries at almost a ONE-THIRD SAVING through the Club's Record-Dividend plan; that is, for every two records purchased (from a group of at least 100 made available annually by the Society) members receive a third RCA VICTOR Red Seal record FREE.

A cardinal feature of the plan is GUIDANCE. The Society has a Selection Panel whose sole function is to recommend "must-have" works. The panel includes: DEEMS TAYLOR, Chairman, composer and commentator; JACQUES BARZUN,

author and music critic; SAMUEL CHOTZINOFF, General Music Director, NBC; JOHN M. CONLY, music editor, *The Atlantic*; AARON COPLAND, composer; ALFRED V. FRANKENSTEIN, music editor, *San Francisco Chronicle*; DOUGLAS MOORE, composer and Professor of Music, Columbia University; WILLIAM SCHUMAN, composer and President, Juilliard School of Music; CARLETON SPRAGUE SMITH, former Chief of Music Division, New York Public Library; G. WALLACE WOODWORTH, Professor of Music, Harvard.

## HOW THE SOCIETY OPERATES

EVERY month three or more 12-inch 33 $\frac{1}{3}$  R.P.M. RCA VICTOR Red Seal records are announced to members. One is singled out as the record-of-the-month and, unless the Society is otherwise instructed (on a simple form always provided), this record is sent. If the member does not want the work he may specify an alternate, or instruct the Society to send him nothing. For every record members pay only \$4.98—for stereo \$5.98—the manufacturer's nationally advertised price. (A small charge for postage and handling is added.)

CIRCLE 27 ON READER-SERVICE CARD

RCA VICTOR Society of Great Music V12-4 22  
P.O. Box No. 3, Village Station  
New York 14, N. Y.

Please register me as a member of THE RCA VICTOR SOCIETY OF GREAT MUSIC and send me the multi-record set whose number I have indicated below, billing me only \$4.98 (plus postage). I agree to buy six additional RCA VICTOR Red Seal Records from the Society within twelve months. For each of them I will be billed the manufacturer's nationally advertised price — \$4.98 for monaural recordings (\$5.98 for stereophonic recordings) — plus a small charge for postage, sales tax and handling. After I have completed my trial membership I need buy only four records in any twelve-month period to maintain membership. I may cancel my membership any time after buying six discs from the Society (in addition to those included in this introductory offer). If I continue after my sixth purchase, for every two records I buy from the Society I will receive a third RCA VICTOR Red Seal record free.

INDICATE BY NUMBER THE MULTI-RECORD SET YOU WANT

CHECK THE DIVISION YOU WISH TO JOIN  
 Regular L.P.  Stereo

Mr. \_\_\_\_\_  
Mrs. \_\_\_\_\_  
Miss \_\_\_\_\_  
(Please print plainly)

Address \_\_\_\_\_

City \_\_\_\_\_ Zone \_\_\_\_\_ State \_\_\_\_\_

NOTE: If you wish your membership enrolled in an authorized RCA VICTOR dealer, please fill in here.

Dealer's Name \_\_\_\_\_

Address \_\_\_\_\_

PLEASE NOTE: Records can be shipped only to residents of the U.S. and its territories, and Canada. Records for Canadian members are made in Canada and are shipped duty free from Ontario.



## A masterpiece and the new ADC-1 Stereo Cartridge

What gives some people a special sensitivity to the world around them—to the things they see, feel and hear? What makes them respond to subtleties of sound that escape all but the most sensitive ears and feelings? Whatever the explanation, the new ADC-1 stereo cartridge was specifically designed for them.

For such people, listening to fine music reproduced with the new ADC-1 is a refreshing, even elating experience. If you are one of them, hear your favored records played with the ADC-1; you'll sense the subtle difference immediately; the experience will startle and delight you. Your records come alive, revealing brilliant highs and thunderous lows free from distortion. You'll hear subtleties of timbre and tone you never suspected were in your discs.

Play your records again and again... Notice that the sound continues to be reproduced at the same fine level; the ADC-1's light tracking force reduces wear to the vanishing point. In addition, surface noise is greatly reduced, increasing your records' dynamic range.

The ADC-1 must be experienced to be enjoyed. Ask your dealer to demonstrate it for you today.



\$49.50

**COMPLIANCE:** 20 x 10<sup>-6</sup> cms/dyne

**DYNAMIC MASS:** .5 milligrams

**OUTPUT:** 7 millivolts @ 5.5 cms/sec

**FREQUENCY RESPONSE:** Unusually flat: plus or minus 2 db. from 10 cps. to 20,000 cps. with useful response extending well beyond 30,000 cps.

**CHANNEL SEPARATION:** 30 db from 50 cps. to 7,000 cps.

**STYLUS TIP RADIUS:** .0006"

**RECOMMENDED TRACKING FORCE:** 1 gram or less in top quality tone arms—up to 3 grams in arms having slightly higher friction.

Audio Dynamics Corporation / 1677 Cody Avenue, Ridgewood 27, N. Y.

**CIRCLE 14 ON READER-SERVICE CARD**

**HIGH FIDELITY MAGAZINE**

## 12 YEARS OF LEADERSHIP

Since 1949 Bozak has occupied a unique position of leadership in the fine quality loudspeaker field. Bozak speaker systems have won worldwide acclaim for realistic musical reproduction—an achievement firmly founded on a noteworthy series of outstanding Bozak "firsts" in the art and science of re-creating voice and music:

*FIRST basic improvement in the woofer—the variable density cone and high compliance, linear suspension;*

*FIRST peak-free tweeter, direct radiating and array mounted for smoothest and most natural treble;*

*FIRST midrange loudspeaker to faithfully reproduce the timbre of musical instruments and voices;*

*FIRST speaker systems with truly modular design to permit systematic growth with a minimum of obsolescence;*

*FIRST single-cabinet stereo system using doors as sound directors—a much copied concept;*

*FIRST speaker manufacturer to offer a variety of enclosures in fine furniture designs, with complementing equipment cabinets;*

*FIRST truly weatherproof high fidelity speaker.*

Year after year, spellbound audiences at demonstrations and Audio Shows attest to the musical qualities of Bozak speaker systems. And year after year, despite steady expansion of production facilities, demand has always exceeded the supply of *handcrafted* Bozak speakers—the ultimate affirmation of leadership.

*Bozak*  
Darien, Conn.

**T H E V E R Y B E S T I N M U S I C**

# Everything...

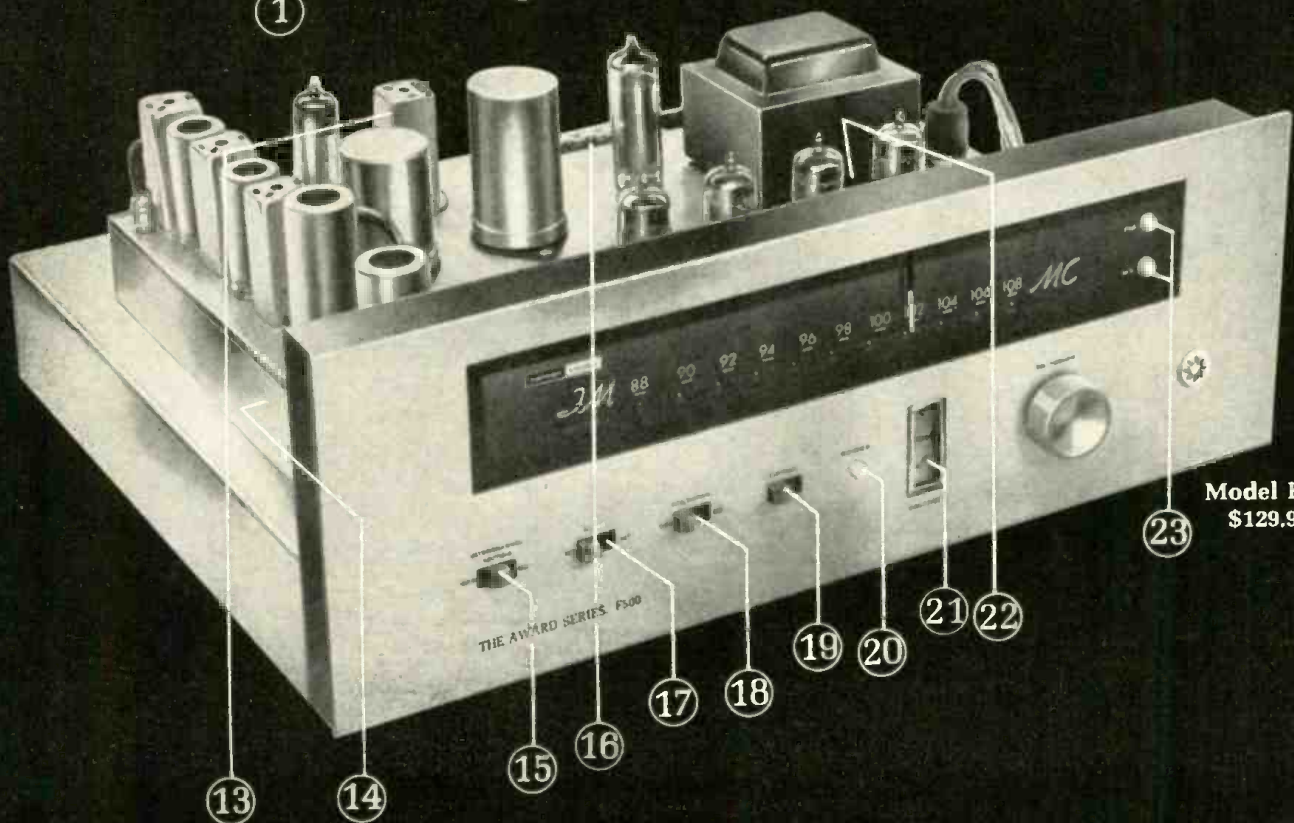
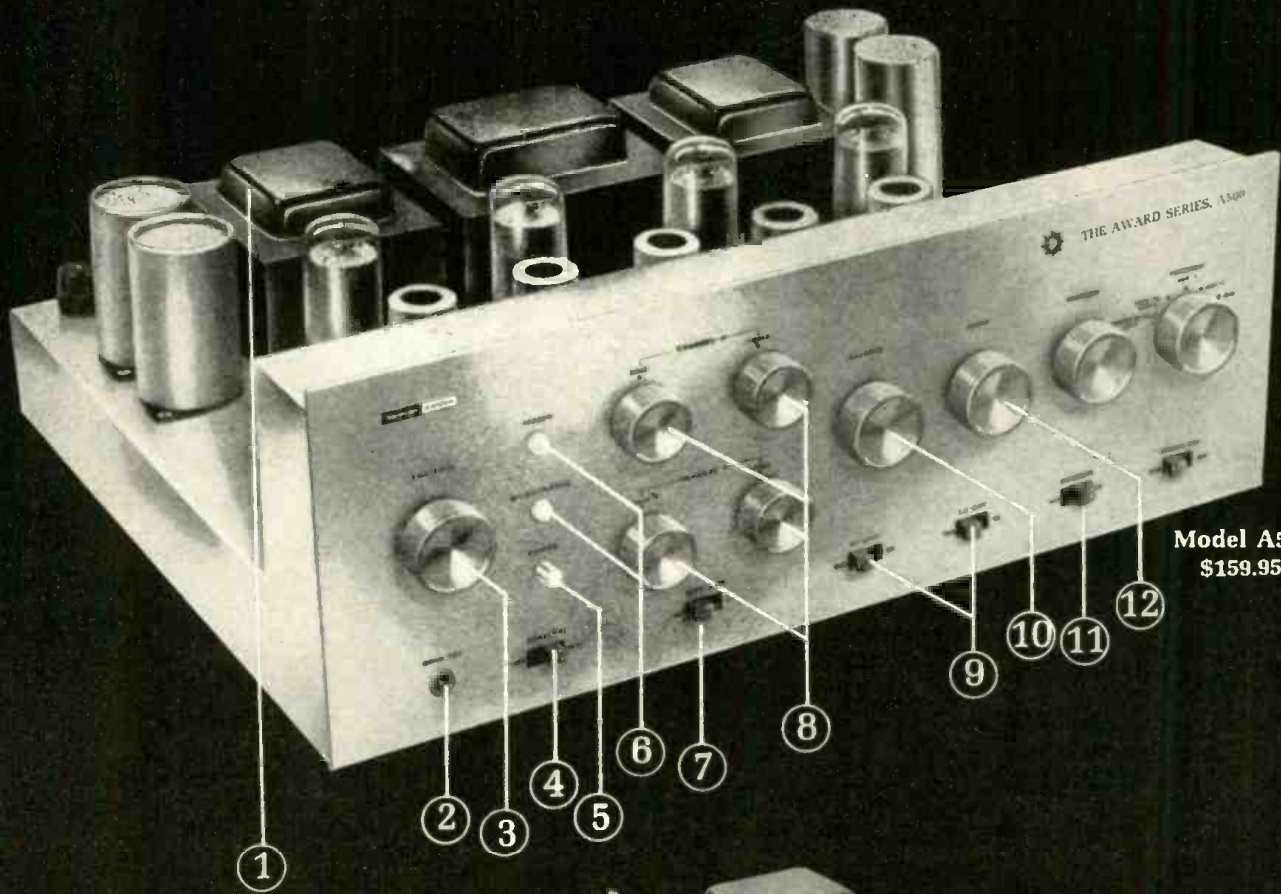

# the knowledgeable listener ever wanted or will ever need: the Award Series by **harman kardon**

**Model A500** powerful 50 watt stereophonic amplifier. Engineered to deliver professional performance at a remarkably low price.

- ① **Massive Output Transformers.** Specially designed to provide frequency response beyond the normal range of human hearing. Phase shift is minimized and flawless reproduction is insured within the audible range.
- ② **Stereo Headphone Input Receptacle:** Conveniently located on front panel to permit easy use of stereo headphones.
- ③ **Ambiance Control:** Acts as a center channel gain control. If an external delay network is used, the ambiance control regulates the amount of signal transferred into it.
- ④ **Speaker Phasing Switch:** Maintains proper speaker phasing for best low frequency response.
- ⑤ **Illuminated Push-Button On/Off Switch:** Permits instrument to be turned on and off without upsetting careful setting of controls.
- ⑥ **Blend Indicator Lights:** Function as precise guide in selection of stereo blend between channels.
- ⑦ **Tape Monitor Switch:** Permits monitoring of tapes while recording.
- ⑧ **Individual Bass and Treble Tone Controls:** Separate controls for each channel.
- ⑨ **Separate Hi-cut and Lo-cut Filters:** To eliminate annoying rumble and record hiss.
- ⑩ **Zero to Infinity Balance Control:** So remarkably effective that it can balance any speaker system regardless of listener's position in the room.
- ⑪ **Stereo Contour Control:** Boosts bass energies at low listening levels.
- ⑫ **Blend Control:** Eliminates "hole-in-the-middle" effect by introducing a variable amount of blend between the two channels.

**Model F500** sensitive, distortion-free FM/Mx tuner.

- ⑬ **Wide-Band Discriminator:** Assures excellent capture ratio with virtually no distortion.
  - ⑭ **Twin Tuning Gangs:** Exclusive Citation design provides outstanding selectivity and eliminates stray capacitance and inductance. Two tuned circuits precede first RF stage for excellent spurious response rejection.
  - ⑮ **Interchannel Muting:** Effectively eliminates interchannel tuning noise.
  - ⑯ **Tuner Output:** Wideband response flat two octaves above and below the normal audible range for "Citation Sound" quality.
  - ⑰ **FM/Multiplex Mode Control:** To switch multiplex adapter into circuit for multiplex reception.
  - ⑱ **Automatic Frequency Control:** With regulated voltage supply maintains absolute oscillator stability regardless of line voltage variation.
  - ⑲ **Range Switch:** To permit excellent reception of distant stations.
  - ⑳ **Illuminated Push Button On/Off Switch.**
  - ㉑ **D'Arsonval Movement Tuning Meter:** Measures discriminator balance and permits perfect visual tuning of all FM stations.
  - ㉒ **Plug-In Multiplex:** Space provided on chassis to accommodate a complete multiplex adapter for FM stereo reception.
  - ㉓ **Stereo Indicator Lights:** Instant visual identification of mode (FM or Stereo) of operation.
- Both instruments are handsomely finished in brushed gold.
- For complete information on the new Award Series, write to: Dept. HF-4, Harman-Kardon, Inc., Plainview, N. Y. All prices slightly higher in the West.

**harman kardon**

CIRCLE 60 ON READER-SERVICE CARD

For commercials, on-the-spot recordings, delayed programming, broadcasters rely on tape—and most stations insist on SCOTCH® BRAND Magnetic Tape



*For studio quality at home,*  
**use the tape professionals use: "SCOTCH" BRAND!**

For the home user as well as for the "pro," getting the desired sound from your recordings depends in great measure on the tape you use. "SCOTCH" BRAND Magnetic Tape—the performance standard of the broadcast industry—provides consistently high-quality recordings that capture sound with the fullest fidelity. Here are important reasons why . . .

The *uniformity* of "SCOTCH" Magnetic Tape—held to microscopic tolerances of backing and oxide thickness—results in the dynamic range being identical throughout each reel, as well as from one reel to another. The *high-potency oxides* used permit a thinner coating that results in greater tape flexibility, more intimate head-to-tape contact

for sharper resolution. Exclusive *Silicone lubrication* impregnates the coating of "SCOTCH" Magnetic Tape with lifetime lubrication that protects the recorder head, eliminates squeal, extends tape life.

Your dealer has a "SCOTCH" Magnetic Tape to match every recording need. Available on 5" and 7" reels in standard and extra-play lengths, with plastic or polyester backing, at economical prices. *Play the favorite!*



MINNESOTA MINING AND MANUFACTURING COMPANY  
 . . . WHERE RESEARCH IS THE KEY TO TOMORROW



"SCOTCH" and the Plaid Design are reg. TM's of 3M Co.,  
 St. Paul 6, Minn. © 1961 3M Co.

CIRCLE 82 ON READER-SERVICE CARD

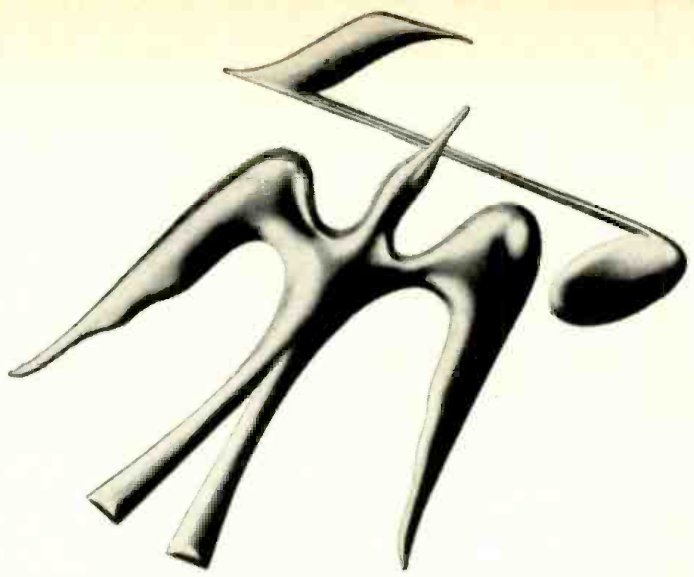

# Why

## DO FISHER OWNERS KEEP ON BEING FISHER OWNERS?

■ ON JANUARY 31, 1938, Professor Richard Humphrey of the Stevens Institute of Technology accepted delivery on a high fidelity receiver, with a dual speaker system, built for him by Avery Fisher. On December 23, 1960, almost twenty-three years later, Professor Humphrey purchased a Fisher 800 receiver. *His original receiver is still working!* Today it is in the Fisher Museum of High Fidelity Equipment. (Its older brother, also in perfect working order, has for some time been in the Smithsonian Institution, in Washington.) In truth, no Fisher instrument has ever worn out. Year after year, they continue to serve their users. *Why* do Fisher owners keep on being Fisher owners? The best answer to that question, as in Professor Humphrey's case, comes from Fisher owners themselves the world over — from the royal palaces at Bangkok and Teheran, to the humblest of Manhattan apartments. Then, too, the answer may come from the many and unique advantages of Fisher equipment described below. Their importance is obvious to the careful buyer.

**ENGINEERING WITHOUT EQUAL** One need only evaluate the products and inventions bearing the Fisher name to realize the calibre and thoroughness of Fisher engineering. To name but one recent example, the world's most remarkable FM tuners, with **MICROTUNE**, are their creation. And this leadership in engineering has prevailed for more than twenty-three years.

**TEST AND INSPECTION** Every single part in a Fisher instrument, *whether you can see it or not*, has been selected as though it were *the* most important part. It is subjected to constant scrutiny and test — from the moment it arrives at our Receiving Department, to the moment the complete instrument is placed in a dust-free, moisture-free plastic bag and sealed in its container for shipment to our customers.

**AUTOMATED ELECTRONIC TEST** Every electronic test and alignment procedure to which a Fisher instrument is subjected is handled by *fully automated instruments* designed and built in our own laboratories by Fisher engineers. Every single piece of equipment receives the same complete and thorough tests. In this vital work all possible errors due to oversight or fatigue have been eliminated.

**RELENTLESS QUALITY CONTROL** Often Fisher standards for component material are so high that there is nothing commercially available. Dual controls for stereo use with *uniform tracking* did not exist in practical form until Fisher engineers set up measuring and testing techniques for our control manufacturers to follow.

**IRONCLAD PACKAGING** No matter how fine a product, no matter how carefully it is made and tested, its mission cannot be accomplished unless it reaches you, the user, in the same flawless condition in which the final inspector approved it. The carton in which every Fisher instrument is protected and shipped is *itself* engineered.

**INSTRUCTION MANUALS** The moment you see your first Fisher Installation and Operating Manual you will know that it is the most complete, easiest to understand, in the entire field. For it was written with affection and respect, written by one who is himself a high fidelity enthusiast, and thoroughly familiar *through personal use* with the equipment about which he writes.

**AFTER-SALES SERVICE** No matter where you live, you are never far from Fisher parts and service. Replacement parts, should they ever be necessary, are shipped *immediately* on request. We still have parts on hand for units we made twenty years ago — parts that were never needed, but still wait their turn to demonstrate the true meaning of the Fisher name on the product you buy.

### WRITE FOR YOUR FREE COPY OF THE FISHER OWNER LIST

■ An eight-page brochure listing hundreds of Fisher owners, a veritable Who's Who of the world's leaders in the sciences, arts, music, publishing, medicine, diplomatic corps, education, finance, theatre, etc. It is the truest index to FISHER quality.



SEND FOR OUR BEAUTIFULLY ILLUSTRATED CATALOGUE OF FISHER STEREO UNITS

FISHER RADIO CORPORATION • 21-25 44th DRIVE • LONG ISLAND CITY 1, N. Y.

# America's Best-Selling Rece

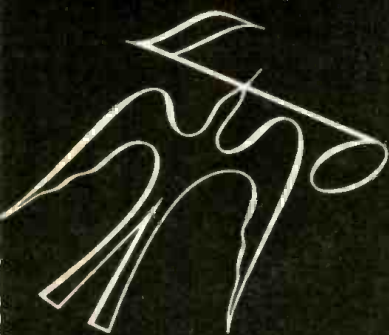

# THE F

## THE FISHER

800



### 70-Watt Stereo FM-AM Receiver

■ In the FISHER 800, everything you need for the foundation of a superb home music system has been incorporated on a single chassis—stereo tuners, stereo controls and stereo amplifiers. Simply connect a turntable and two speakers—and your music system is *complete*. Tuners, controls, amplifiers all work as a close-knit team to achieve listening perfection. Whether you live in town, or in the far suburbs, the wide-band high-sensitivity tuners of the 800 assure perfect, drift-free reception on FM and AM. The amplifiers have tremendous reserve power—70 watts—producing absolutely pure sound, at whisper or auditorium levels. The controls are so logically arranged that operation is simple, even for the most unskilled user. The FISHER 800 has been built specifically for perfectionists, for those who want superior quality in its most compact form. 20 tubes, 4 diodes.

SIZE: 17" wide, 13 $\frac{7}{8}$ " deep, 4 $\frac{13}{16}$ " high. \$429.50

WRITE TODAY FOR COMPLETE DETAILS

## THE FISHER

500-S



### 45-Watt Stereo FM-AM Receiver

■ The FISHER 500-S brings world-renowned FISHER quality and FISHER features within reach of the widest possible audience. In spite of its moderate dimensions, the 500-S is a giant in performance, designed for easy installation anywhere. Like its senior counterpart, the FISHER 800, the 500-S needs only a pair of speakers and a turntable for a complete stereophonic home music system. FM and AM tuners, stereo controls and the massive 45-watt dual-channel amplifier are all contained on a single, compact chassis. Both FM and AM tuners are of advanced wide-hand design, assuring crystal-clear radio reception of full tonal range. The AM signal is, in fact, of such high calibre that it rivals FM in tone quality. The controls are so simple that a child can operate them, yet they provide a versatility that will satisfy the most demanding connoisseur. 19 tubes, 3 diodes, 2 silicon rectifiers.

SIZE: 17" wide, 13 $\frac{7}{8}$ " deep, 4 $\frac{13}{16}$ " high. \$349.50

WRITE TODAY FOR COMPLETE DETAILS



# ivers and Control-Amplifiers

# FISHER

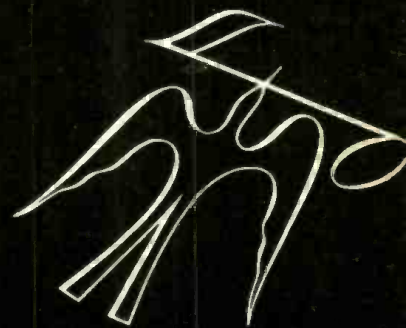

## THE FISHER X-202



### 50-Watt Stereo Control-Amplifier

■ Fifty watts of conservatively rated music power, and the superior versatility that is so characteristic of FISHER design are yours in the FISHER X-202 Stereophonic Control-Amplifier. At little more than the cost of standard units you get the bonus of performance and reliability that has long been associated with the FISHER name. No other control-amplifier—in its price class, or far above—has so much to offer. Where space is limited, the Stereo Dimension Control creates a blending of channels without the need of a third, center-channel speaker. Volume and stereo balance can be adjusted from your favorite chair by adding the FISHER RK-1 Remote Control unit (\$17.95). The Center Channel Volume Control serves either three-channel stereo or a remote monophonic installation. In every way, your new FISHER X-202 will give you finer, more realistic reproduction of music. 13 tubes. SIZE: 15 $\frac{1}{8}$ " wide, 12 $\frac{1}{2}$ " deep, 4 $\frac{3}{16}$ " high. **\$229.50**

WRITE TODAY FOR COMPLETE DETAILS

## THE FISHER X-100



### 36-Watt Stereo Control-Amplifier

■ FISHER quality at moderate cost! The X-100 is a 36-watt stereo amplifier with its own Master Audio Control—both on a single compact chassis. Twenty-three years of FISHER leadership in high fidelity design are reflected in its flexibility and in its flawless reproduction of music. The performance of the X-100 actually exceeds that of many amplifiers claiming higher power ratings. The preamplifier has fourteen inputs for every type of phono cartridge, tuner, and tape equipment now available. Controls are so logically arranged that anyone can operate the X-100 with ease, yet the versatility they provide will delight even the most exacting audio enthusiast. Your own ears will be the best judge. Hear the FISHER X-100 at your dealer's. When you do, you will realize how much FISHER engineering and FISHER quality standards can add to your enjoyment of music. 11 tubes. SIZE: 15 $\frac{1}{8}$ " wide, 11 $\frac{7}{8}$ " deep, 4 $\frac{3}{16}$ " high. **\$159.50**

WRITE TODAY FOR COMPLETE DETAILS

44th DRIVE • LONG ISLAND CITY 1, N.Y.

EXCITING NEW HARMONIOUS ELEGANCE!

# Authentic Provincial Design IN ACOUSTICAL CABINETRY for Your High-Fidelity Components



## Italian Provincial

CABINET ENSEMBLE  
Model 600-601

Beautiful way to combine the warmth and elegance of authentic provincial design with your own choice of famous-name high-fidelity components for finer mono or stereo. Decorator-styled, acoustically-engineered and furniture-crafted for long-life enjoyment.

ITALIAN PROVINCIAL *Center Equipment Cabinet* (Model 600) with lift top is designed to house amplifier and/or preamplifier or tuner, any record changer or most transcription tables or tape recorders. Space for 100 LP records, and books or decorative display. Free-Standing *Twin Speaker Enclosures* (Model 601) permit proper stereo separation for desired listening in any room. Each houses up to 12-inch loudspeaker. *Cabinet Ensemble* (Model 600-601) in Fruitwood or Oil Walnut finish. Also available on special order in Hand-Rubbed Mahogany, Blonde, or Ebony.

Open view at right shows compartments in either of the Italian or French Provincial Equipment Cabinets



## French Provincial

CABINET ENSEMBLE  
Model 1100-1101

FRENCH PROVINCIAL *Center Equipment Cabinet* (Model 1100) is designed for any record changer, transcription table, or tape recorder, amplifier and/or preamplifier or tuner. Has space for 150 LP record albums and other use. Free-Standing *Twin Speaker Enclosures* (Model 1101) permit proper stereo positioning for thrilling reproduction. Each houses up to 15-inch loudspeaker. Includes adapter board for 12-inch speaker. Also accommodates tweeters. *Cabinet Ensemble* (Model 1100-1101) of Cherry finished in Fruitwood.

See Your High-Fidelity Dealer  
or Write Now for Bulletin R-20-H  
Most versatile line of high-fidelity  
cabinetry created by specialists  
in acoustic design and  
fine furniture manufacture.

FURNITURE-CRAFTED BY  
**ROCKFORD**  
SPECIAL FURNITURE CO.  
2024 TWENTY-THIRD AVE • ROCKFORD, ILL.

CIRCLE 100 ON READER-SERVICE CARD



## Letters

### On Record Catalogues

SIR:

Your January issue devoted to France reminds me that I have recently received my copy of the *Catalogue Général, Disques de longue durée* for 1961. There seems to be something creative and artistic in the way the French do things, and the *Catalogue* is no exception. This new edition contains 510 pages, with a full-color cover of a reproduction of the "Concert Champêtre" by François-Hubert Drouais (hanging in the Versailles Museum).

Many readers will probably remember the excellent catalogues printed by RCA Victor and Columbia in the late '30s, as well as the HMV catalogues of the immediate postwar period. These were veritable gems, being not only catalogues, but miniature encyclopedias for music lovers, too. Of course, these catalogues were issued only once a year (as the French one is now), supplemented monthly by listings.

The French catalogue is published by *Disques Magazine*. One wonders if the readers of *HIGH FIDELITY* are interested in a similar publication for American collectors.

Elmer Wong  
Portland, Ore.

Only the readers can answer that. Comments invited.—Ed.

### More Milanov Militants

SIR:

As a devoted admirer of Zinka Milanov, I regard my recordings of this great soprano as my most treasured possessions.

I think all her fans will agree with me that there should be more Milanov recordings. After inquiring about this at RCA Victor, I was told that Mme. Milanov is not under contract to that company at this time. It seems to me that this situation calls for action, and so I am asking all those who share my admiration to write letters of petition and send them to me. I shall forward copies of these letters to various recording companies, asking for further

Continued on page 18

HIGH FIDELITY MAGAZINE

# 338 Mile FM Reception!

WITH THE **FISHER FM-200**



THE FISHER FM-200 • UNCONDITIONALLY GUARANTEED TO OUTPERFORM ANY FM TUNER IN THE WORLD

## *A Milwaukee Physician Writes Us:*

"I have logged stations in Chicago I had never heard before, as well as Kalamazoo, Michigan and Cleveland, Ohio—yes, Cleveland, Ohio! Furthermore, I was able to reach through and separate WFMF in Chicago (100 miles away) from WRJN-FM in Racine, 25 miles away and *directly in the path of the Chicago station*. I have never accomplished this before!"

WNCN, New York outlet of the Concert Network, uses a FISHER FM-200 for absolutely reliable reception of their Hartford affiliate, for rebroadcast to the New York area. They write us: "The FM-200 is very good in rejecting strong signals which overload many tuners or cause noise."

■ Here is dramatic proof *in action* of the true meaning of the FM-200's unique specifications. No FM tuner in all the world can match it, because the FM-200 is the *only* tuner in the world with SIX i.f. stages, with FIVE limiters, with 0.5 microvolt sensitivity, and with a capture ratio of 1.5 db—by a wide margin *the finest ever achieved*.

Consider MICROTUNE, the FISHER invention that makes absolutely accurate tuning of this wide-band tuner child's play, as well as many other amazing specifications too numerous to mention here, and you will know why the FM-200 will never see its equal. **IMPORTANT:** All specifications on the FM-200 you buy are personally guaranteed to you, the owner, by Avery Fisher, President. 11 tubes, 4 diodes, bridge type selenium rectifier. 15½" wide x 12¾" deep x 4¾" high. WEIGHT: 17 lbs. \$229.50



**FISHER 202-R**, Stereophonic Tuner with FM section identical to the FM-200, plus an AM tuner with an FM-calibre tonal range. \$329.50

### SPECIAL NOTICE TO ALL FM STATIONS

In addition to its regular outputs, the FISHER FM-200 has a 600-ohm output impedance. It also has a 72-ohm coaxial antenna connector.



WRITE TODAY FOR THE COMPLETE SPECIFICATIONS OF THE REMARKABLE FM-200. ASK FOR BULLETIN TBT-2.

**FISHER RADIO CORPORATION • 21-25 44th DRIVE • LONG ISLAND CITY 1, N. Y.**

EXPORT: Fisher Export Division, 21-21 44th Drive, L.I. City 1, N. Y. • In Canada: Canadian Marconi  
CIRCLE 51 ON READER-SERVICE CARD

*Schober*  
 captures  
 magnificent  
 pipe organ  
 tone  
 in a  
 tiny  
 electronic  
 tube . . . . .

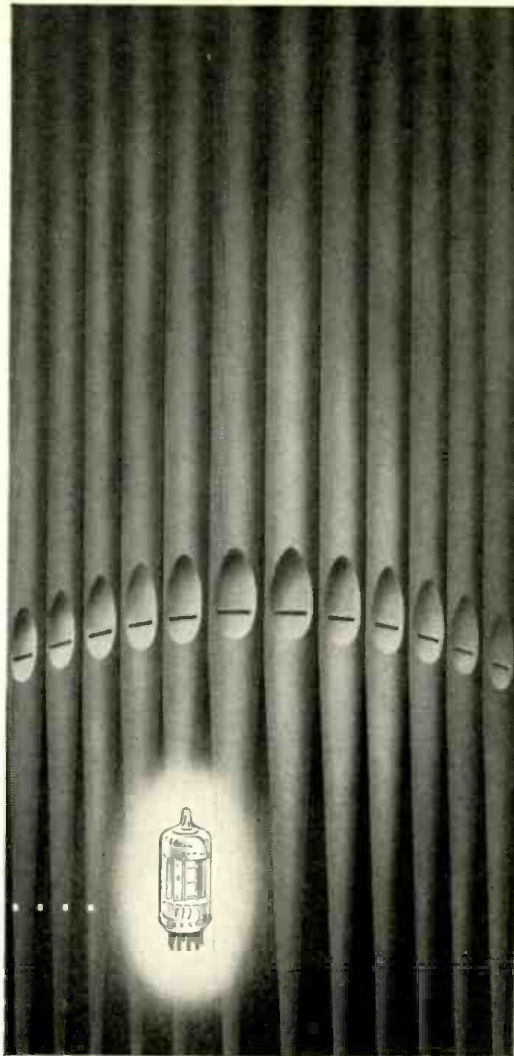

**H**ere is magnificent Pipe Organ tone; tremendous tonal color range; two 61-note pipe-organ keyboards; hand-rubbed cabinetry in the finish of your choice. Taken together they comprise a superlative electronic instrument comparable to organs selling for \$2,500 to \$6,000.

Yet, when you assemble the Schober of your choice, you save more than half the normal cost and create a superb instrument to bring the delightful gift of music to your family.

Matched kits and printed circuitry make it possible.

Work requiring knowledge and experience is eliminated. All that remains is the pride and pleasure of watching a fine musical instrument take shape under your own hands. The Schober organ you assemble will equal or surpass any factory-built organ for quality, reliability and circuitry.

And the Schober electronic Organ is so easy to play!

From the very first day even novices will transform simple tunes into deeply satisfying musical experiences — because unlike a piano whose tone dies away almost as soon as the keys are struck, organ tones continue to sing out as long as the key is held down. Then, by simply moving your right foot, you change the volume so that the sound becomes rich and alive.

The coupon brings you full details on how you can start building the Schober of your choice with an investment of as little as \$18.95. In addition, you may have an exciting 10" LP record demonstrating Schober's full range of tones and voices. The \$2 charge for the record is refunded when you order your starting kit. No salesman will call.

**MAIL THIS COUPON TODAY**

**THE Schober Organ CORPORATION**  
 Dept. HF-6 43 WEST 61ST STREET, NEW YORK 23, N.Y.

The Schober Organ Corp., Dept. HF-6  
 43 West 61st Street, New York 23, N.Y.

- Please send me FREE full-color booklet and other literature on the Schober organ.
- Please send me the Hi-Fi demonstration record. I enclose \$2 which is refundable when I order my first kit.

name \_\_\_\_\_  
 address \_\_\_\_\_  
 city \_\_\_\_\_ zone \_\_\_\_\_ state \_\_\_\_\_



CIRCLE 102 ON READER-SERVICE CARD

LETTERS

Continued from page 16

Milanov releases. I am sure Mme. Milanov would not object to this procedure. Thank you all!

Inga Holst  
 135 Whitford Street  
 Roslindale 31, Mass.

Chansonniers Over the Border

SIR:

Mr. Indcox's article (HIGH FIDELITY, January 1961) on the *chansonniers* of France indicates that there is an audience for their songs in the United States. That audience might be interested to learn that some of the *chansonniers* are much more substantially represented on LP in Canada than they are on your side of the border. Canadian Columbia and Canadian Epic have been issuing a wide variety of this music, including some remarkable work by the youngest generation of *chansonniers*—people like Francis Lemarque, Guy Béart, and Sacha Distel—in addition to more familiar performers such as Montand (Columbia) and Brassens (Epic). Jacques Brel, recently added to the United States catalogue for the first time (see HIGH FIDELITY, December 1960), has been known to Canadian collectors for some time.

Two excellent male vocal quartets, both recorded by Canadian Columbia, are often as entertaining as the solo performers: Les Quatre Barbus and Les Frères Jacques. There are many others, including several fine records for children.

These Columbia-Epic LPs seem to have been successful enough to stimulate Canadian Capitol to adopt a similar policy, using the Pathé label for their Canadian pressings of French popular music. On this label we have quite recently had recordings by Charles Trenet, Gilbert Beaud, and Les Compagnons de la Chanson, among others.

These discs are not listed in Schwann, and I don't know whether any record stores in your country carry them. I would think collectors could find out about them by writing to the American record companies. I should point out that these LPs, intended mainly for French-Canadian listeners, are without notes, texts, or translations.

John Walker  
 Toronto, Canada

Tape Flexibility

SIR:

I have been disturbed lately by 4-track stereo tape manufacturers' practice of duplicating the turn-over points found on the equivalent stereo discs, even if such a break is in the middle of a symphonic movement. The technical necessity for this, which is doubtful even on a stereo disc, would seem to be absolutely nonexistent on a tape.

Both the London and RCA Victor tape

Continued on page 20

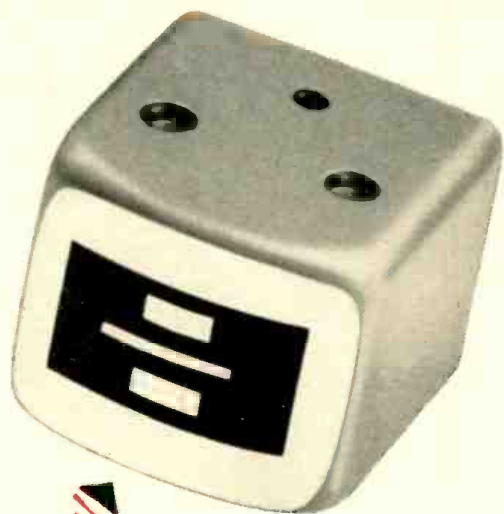

*Here's where Soundcraft Tapes with FA-4 outperform any other tape you can buy!*

There is no fooling a recording head ... it knows! It can reproduce only that which your tapes are capable of recording. To thousands of professional and amateur tape recordists, one tape has proven its ability to reproduce sound with a quality that is unmatched. That tape is Soundcraft with FA-4—the exclusive frequency adjusted formulation that captures the full dynamic range of sound. It costs no more to discover how well your tape recorder can perform.

## REEVES **SOUNDCRAFT** CORP.

Great Pasture Rd., Danbury, Conn. ■ Chicago: 28 E. Jackson Blvd.  
Los Angeles: 342 N. LaBrea ■ Toronto: 700 Weston Rd.

P.S. Your recording head will appreciate Soundcraft's built-in lubrication.

CIRCLE 94 ON READER-SERVICE CARD

Continued from page 18

Listen!



It's the new  
Sonotone Ceramic "Velocitone"

No stereo cartridge—not even the finest magnetic in the world—outperforms it!

**Listen!...** with your own magnetic... or with any magnetic you can buy today—at any price. Then replace it *directly* in your component system with Sonotone's new "VELOCITONE" STEREO CERAMIC CARTRIDGE ASSEMBLY. Listen again! We challenge you to tell the difference. Experts have tried... in dozens of A-B listening tests. And, in every single one, Sonotone's "VELOCITONE" performed as well as or better than the world's best magnetic.

**Listen!...** perfectly flat response in the extreme highs and lows (better than many of the largest-selling magnetics).

**Listen!...** excellent channel separation—sharp, crisp definition.

**Listen!...** highest compliance—considerably superior tracking ability.

**Listen!...** absolutely no magnetic hum—quick, easy, *direct* attachment to any magnetic inputs.

**Listen!...** remarkable performance characteristics unexcelled anywhere. (Write Sonotone Corporation for specifications.)

Now listen to the price. Only \$23.50... about one-half the price of a good stereo magnetic cartridge. Yet Sonotone's "VELOCITONE" stereo ceramic cartridge system cannot be outperformed by any magnetic—regardless of price.



**Sonotone**®  
C O R P.

ELECTRONIC APPLICATIONS DIVISION, ELMSFORD, N. Y., DEPT. C4-41  
IN CANADA, CONTACT ATLAS RADIO CORP., LTD., TORONTO

LEADING MAKERS OF CARTRIDGES • SPEAKERS • TAPE HEADS • MIKES • ELECTRONIC TUBES • BATTERIES  
CIRCLE 111 ON READER-SERVICE CARD

versions of Berlioz's *Symphonie fantastique* make a break about five minutes into the third movement. The extra tape required to place all of this five minutes' music at the beginning of Sequence B would not seem to be too great—particularly when RCA, for instance, can allow about five or six minutes of blank tape at the conclusion of its Montoux version of the Haydn *Surprise* Symphony.

Shouldn't manufacturers realize that one of the great advantages of tape over discs is the possibility of greater continuity of the musical performance? There is certainly no sense in the consumer's paying extra money to duplicate the inadequacies of stereo discs. In this connection, I am encouraged by the tendency towards "Twin-Paks," which provide this continuity to an extent a disc will never achieve.

I hope that the 4-track tape industry (particularly those producers holding the recording contracts of major artists and orchestras) will soon begin to exploit those inherent superiorities of the tape medium which can provide greater aesthetic as well as aural pleasure.

John W. Kimball  
Arlington, Va.

*Recording engineers affirm that they try, whenever practical, to duplicate the turn-over points of stereo discs in stereo tapes. These breaks generally occur at the most logical places—between movements. Engineers agree, at the same time, that tape affords more flexibility than discs in determining the turn-over point. There is, however, a problem in taking advantage of this feature. It is felt that the additional tape used would increase cost to the purchaser, which would mean widely varying tape prices and general confusion. The instance of "five or six minutes of blank tape" is held to be an exception rather than a standard recording practice.—Ed.*

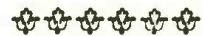

**High Fidelity**, April 1961, Vol. 11, No. 4. Published monthly by The Billboard Publishing Co., publishers of *Billboard Music Week*, *Vend. Amusement Business*, and *Billboard Music Week Overseas Edition*. Telephone: Great Barrington 1300. Member Audit Bureau of Circulations.

**Editorial Correspondence** should be addressed to The Editor, High Fidelity, Great Barrington, Mass. Editorial contributions will be welcomed. Payment for articles accepted will be arranged prior to publication. Unsolicited manuscripts should be accompanied by return postage.

**Change of Address** notices and undelivered copies should be addressed to High Fidelity, Subscription Fulfillment Department, 2160 Patterson Street, Cincinnati 22, Ohio.

**Subscriptions:** Subscriptions should be addressed to High Fidelity, Great Barrington, Mass. Subscription rates: United States, Possessions, and Canada, 1 year, \$6; 2 years, \$11; 3 years, \$15; 5 years, \$20. Elsewhere \$1 per year extra. Single copies 60 cents.

# McIntosh is the best amplifier'

No amplifier meets or exceeds McIntosh performance. The best test equipment available proves McIntosh amplifiers are the best.

McIntosh is the best amplifier available! This is the most frequent comment found on the warranty cards sent to us. To support the good judgement of the many thousands who have bought McIntosh amplifiers we make this statement:

Only McIntosh amplifiers will deliver the full advertised power\* at the lowest harmonic distortion of any currently available nationally advertised amplifiers in the McIntosh power class, at all frequencies, 20 cycles through 20,000 cycles.

We challenge any other manufacturer to prove that his power amplifier in the McIntosh power class, will deliver full advertised power at all frequencies, 20 cycles through 20,000 cycles at less than 0.5% harmonic distortion.

Any impartial testing person or organization can reach these same conclusions when reputable test instruments and procedures are used.

To assure the continued highest quality and performance, every McIntosh amplifier is measured by the use of these quality test instruments:

1. Hewlett Packard #206A Signal Generator.
2. Hewlett Packard #330B Distortion Analyser.
3. Techtronic #502 Dual Beam Oscilloscope.
4. Non Inductive Load Resistor.

McIntosh amplifiers meet many performance requirements. Some of these requirements are:

#### HARMONIC DISTORTION:

Less than 0.5% at advertised power output or less for all frequencies in the audio range, 20 cycles through 20,000 cycles. Typical performance less than 0.3%, 20 cycles through 20,000 cycles.

#### INTERMODULATION DISTORTION:

Less than 0.5% for any combination of frequencies, 20 cycles through 20,000 cycles, provided peak power does not exceed twice the output power rating.

#### FREQUENCY RESPONSE:

$\pm 0.1$  db, 20 cycles through 20,000 cycles, at advertised power output.

#### PHASE SHIFT:

$\pm 8^\circ$ , 20 cycles through 20,000 cycles.

#### NOISE AND HUM:

Better than 90 db below advertised power output.

Ever since the introduction of the first McIntosh amplifier, over ten years ago, the name McIntosh has represented the best amplifiers. The excellent performance has not been equalled, much less exceeded, by any other amplifier—except on the printed page.

McIntosh amplifiers were the first amplifiers to offer the lowest distortion, flat power response, and highest efficiency. And McIntosh amplifiers still offer the lowest distortion, flat power response, highest efficiency, and are still the best. To support our customers, McIntosh Laboratory challenges other amplifier manufacturers to prove their advertised performance. McIntosh does!

# McIntosh

LABORATORY, INC.

2 CHAMBERS STREET, BINGHAMTON, N. Y.

Phone—Area Code 607-723-5491

\*Continuous power as measured by the square of the RMS output voltage, divided by the resistance of the non-inductive load resistor.

## a touch of Crosby...

The 680. 28-watt stereo preamp/amplifier is small in price but a giant performer. Includes advanced design and control features—push-button source selection, too—found only in units costing far more than its low, low \$119.95 . . . including enclosure.

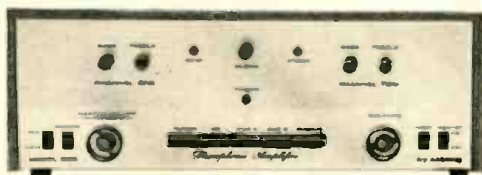

The 690. This FM tuner is the design-mate of the 680 in size and appearance. Incorporates super-sensitive, no-drift circuitry, variable interstation noise-muting control, dial-variable amplified AFC, plus chassis provision and power supply for Multiplex adapter. The price — \$99.95 . . . including enclosure.

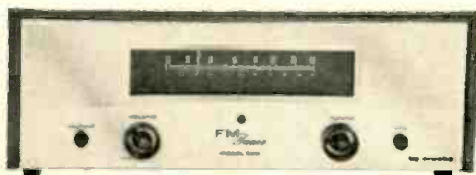

Prices Slightly Higher West of Rockies

The R80. An 80-watt stereo receiver that is simplicity to operate and beauty to behold. Filled with avant garde performance features — including front panel Multiplex dimension control to eliminate the possibility of obsolescence — yet priced at \$375.00. Optional enclosures.

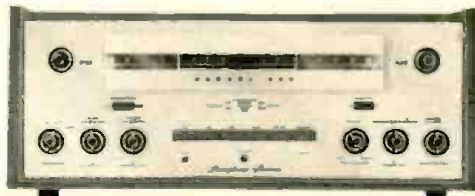

The 650. Complete 28-watt stereo receiver, modestly priced but expensively featured—so handsomely compact, it's been called "stereo in a nutshell". Out-values any other receiver made — in appearance, performance and cost — just \$219.95. Optional enclosure.



Using the know-how and technology normally reserved for military electronics, Murray G. Crosby has created an outstanding line of stereophonic high fidelity components for the home music systems of the most discerning patrons of the art . . . and priced for enjoyment.

# stereo BY Crosby

Crosby Electronics, Inc. a subsidiary of Crosby-Teletronics Corporation, Syosset, Long Island, N. Y.

Manufacturers and designers of stereophonic components, speakers and the Crosby Compatible Stereo FM Multiplex System.

CIRCLE 38 ON READER-SERVICE CARD



**two NEW speakers from**

**H H SCOTT**

**H H SCOTT**

**H H S T**

**H H S T**



**MODEL S-2  
ONE OF TWO NEW  
SPEAKER SYSTEMS**

**turn page for exciting details**



**CIRCLE 104 ON READER-SERVICE CARD**

✓ Musical Test

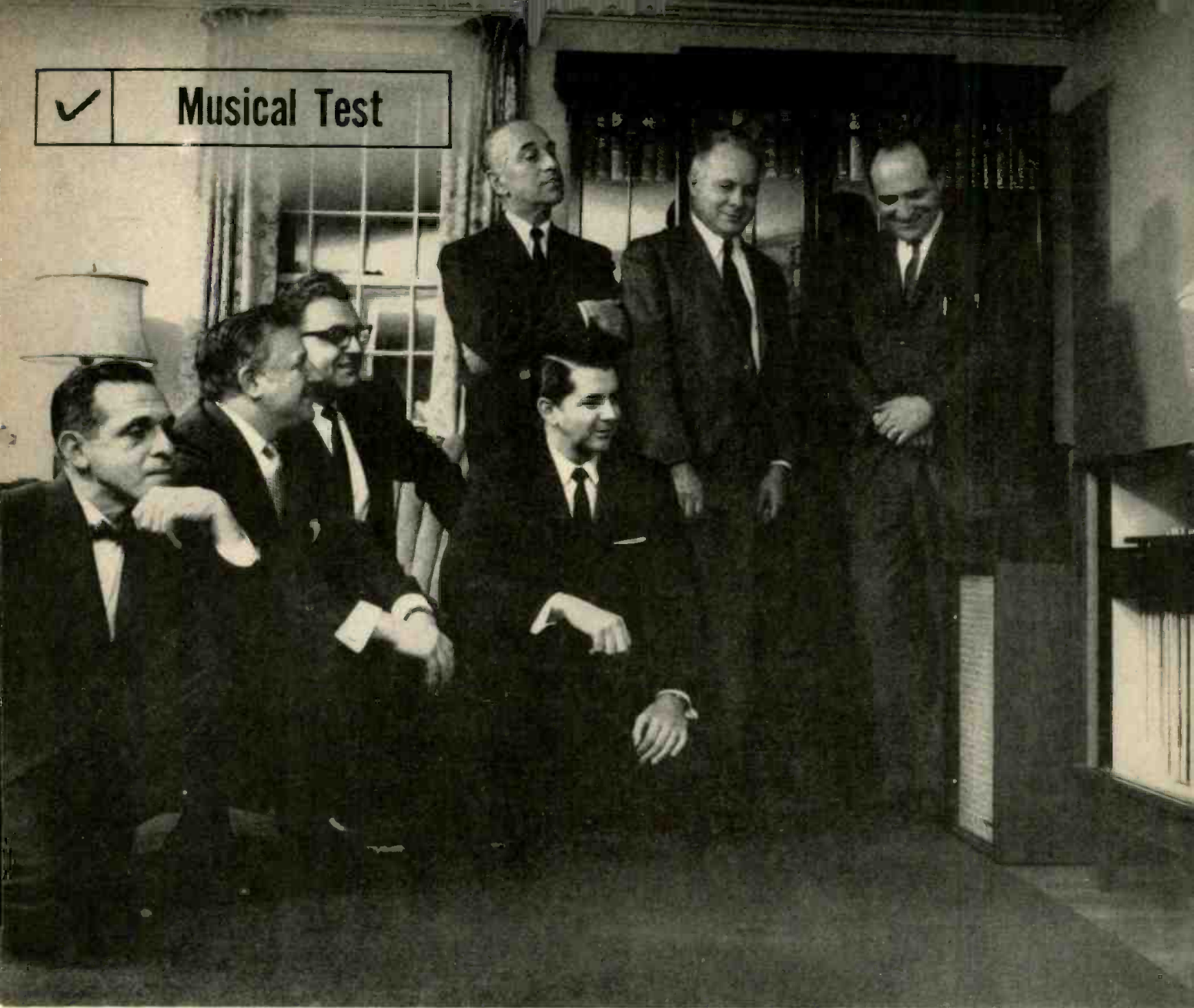

Distinguished panel of musicians from Boston's famous symphony orchestra evaluate speaker performance in home of Hermon Hosmer Scott, Lincoln, Mass.

## Famous musicians and engineers first to hear remarkable new H. H. Scott speakers!

To assure perfection in his new speaker systems, Hermon Scott subjected them to home listening and technical tests.

For the listening test he invited the most critical audience available . . . highly skilled professional musicians from Boston's famous symphony orchestra . . . to hear their own performances reproduced over the new H. H. Scott speakers. Here are their enthusiastic reactions:

*"The closest I have heard to the true sound of the violin. I was not even aware I was listening to a recording."* Leonard Moss, Violinist. *"The trumpet sound was uniform and consistent in every range, from the lowest to the highest note . . . a feat virtually unheard of in any other speaker."* Roger Voisin, First Trumpet; Recording Artist, Kapp Records. *"I have never heard any reproduction of organ which sounded so faithful to the original. I felt I was sitting in the center of Symphony Hall."* Berj Zamkochian, Organist. *"Every other speaker I ever heard sounded nasal and artificial. This was the first one that did not."* Bernard Zighera, First Harpist and Pianist. *"I was in the control room when this recording was made. Played through these new speakers, the reproduction was closer to the original performance than I've ever heard before."* James Stagliano, First Horn; Recording Artist, Boston and Kapp Records. *"The percussion came through with amazing clarity. The cymbals, the snare drum, the tympani and the bass drum all were equally true to the way they sound when I play."* Everett Firth, First Tympanist.



The famous musicians in Hermon Scott's living room are: 1. Leonard Moss (Violin), 2. James Stagliano (Horn), 3. Berj Zamkochian (Organ), 4. Everett Firth (Tympani), 5. Bernard Zighera (Piano), 6. Hermon Scott, 7. Roger Voisin (Trumpet).

CIRCLE 105 ON READER-SERVICE CARD

✓ **Engineering Test**

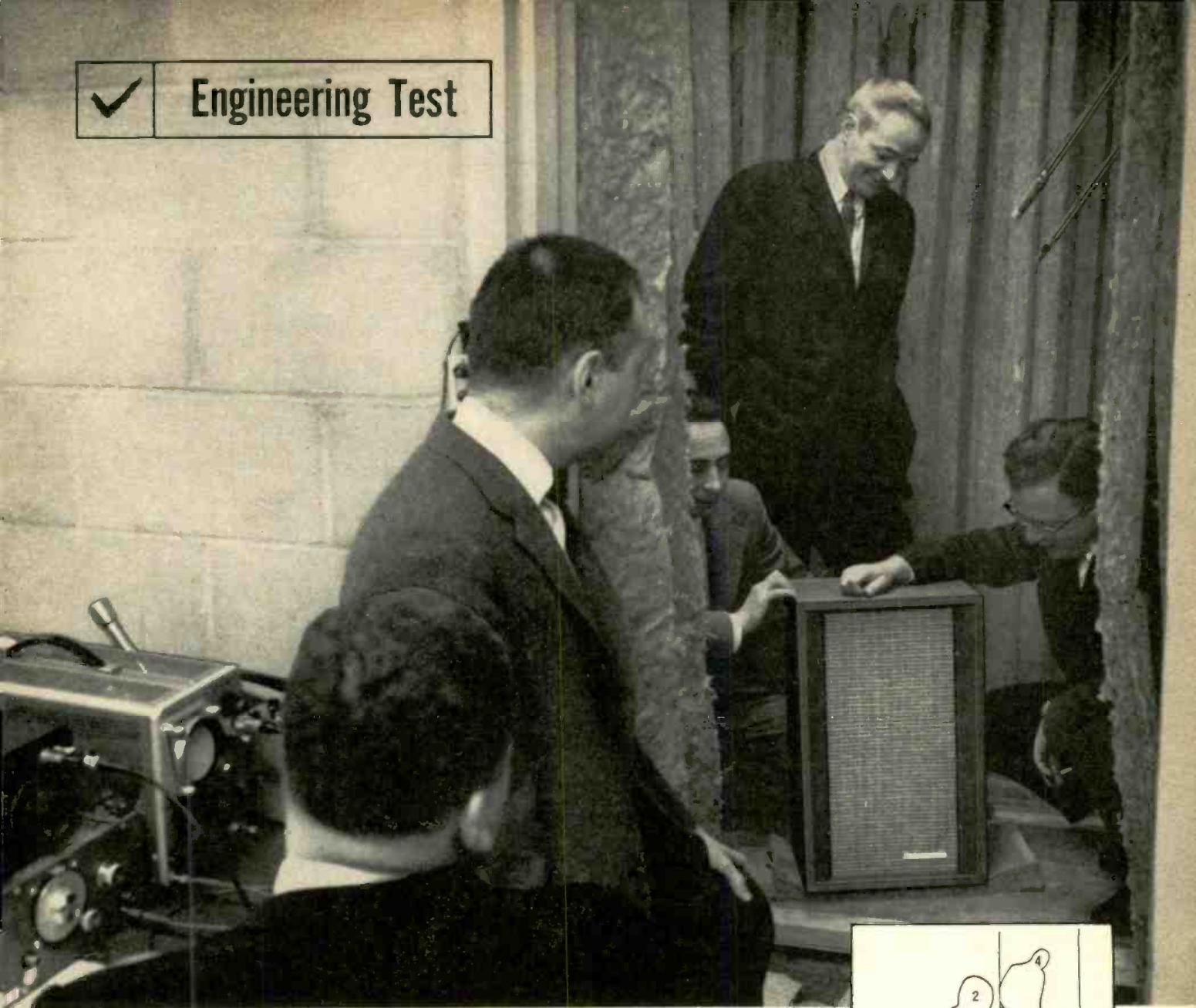

Scientists watch while Peter Globa, Speaker Development Engineer, makes exacting measurements of the new H. H. Scott speaker in anechoic chamber.

To show that the new H. H. Scott speaker systems are excellent technically as well as musically, Hermon H. Scott invited this distinguished panel of scientists to preview the performance of the new models.

As with its tuners and amplifiers, H. H. Scott uses new techniques in both construction and testing that represent a significant advance in the state of the art. New construction methods assure excellence in performance . . . New testing techniques and quality controls substantially reduce variations in quality from speaker to speaker, common until now.

Every H. H. Scott speaker is individually tested to assure rigid adherence to specifications. Each speaker carries a 2 year guarantee. Hear the new S-2 and S-3 at your dealer soon. We are sure you will agree that these speakers are the finest musical reproducing systems ever made.

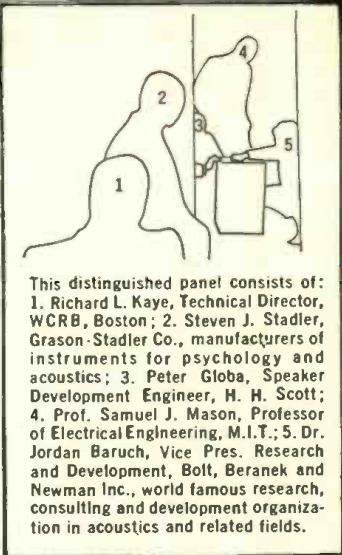

This distinguished panel consists of: 1. Richard L. Kaye, Technical Director, WCRB, Boston; 2. Steven J. Stadler, Grason-Stadler Co., manufacturers of instruments for psychology and acoustics; 3. Peter Globa, Speaker Development Engineer, H. H. Scott; 4. Prof. Samuel J. Mason, Professor of Electrical Engineering, M.I.T.; 5. Dr. Jordan Baruch, Vice Pres. Research and Development, Bolt, Beranek and Newman Inc., world famous research, consulting and development organization in acoustics and related fields.



**H. H. SCOTT MODEL S-2 WIDE RANGE SPEAKER SYSTEM:**

This four-driver, acoustic compliance system consists of a low resonance, high excursion woofer, two dual-cone mid-range units, and a special wide dispersion spherical tweeter mounted in a matched cabinet. Mid-range units acoustically isolated to eliminate undesirable coupling and intermodulation. Actual impedance 16 ohms. Dimensions: 23 3/4" H x 14 1/2" W x 12 1/2" D. Available in mahogany (\$199.95), oil finish walnut (\$199.95), fruitwood (199.95) and unfinished (179.95).\*



**H. H. SCOTT MODEL S-3 WIDE RANGE SPEAKER SYSTEM:**

A three-way acoustic compliance system of true book shelf size. Consists of a specially designed low resonance woofer, a mid-range unit and a wide-dispersion super-tweeter, mounted in a matched enclosure. Actual impedance 16 ohms. Dimensions: 23 1/2" H x 11 3/4" W x 9 3/4" D. Available in mahogany (\$129.95), oil finish walnut (\$129.95), fruitwood (\$129.95) and unfinished (114.95).\*

(\*Slightly higher west of Rockies)

**H. H. SCOTT**

H. H. Scott Inc.  
111 Powdermill Road, Dept. 226-04  
Maynard, Mass.

Please send me complete information on your new speakers and your new H. H. Scott Guide to Custom Stereo.

Name \_\_\_\_\_

Address \_\_\_\_\_

City \_\_\_\_\_ State \_\_\_\_\_

Export: Telesco International Corp.,  
171 Madison Avenue, N. Y. C.

CIRCLE 128 ON READER-SERVICE CARD



**World's Only Portable Recording Studio...**

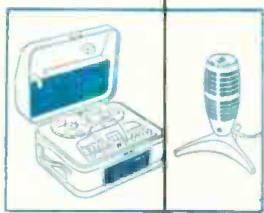

the all-in-one **Norelco**  
CONTINENTAL '400'  
4-Track Stereo Tape Recorder

*A recording studio in a suitcase—that's how Norelco '400' owners describe this most advanced (and most popular) self-contained stereo tape recorder. VERSATILITY: 4-track stereo recording and playback, as well as 4-track monophonic recording and playback, at any of its 3 speeds. FREQUENCY RESPONSE: at 7½ ips, 50-18,000 cps; at 3¾ ips, 50-14,000 cps; at 1¾ ips, 60-7000 cps (yes, its response at 3¾ ips is actually equal to or wider than the response of most costlier machines at 7½ ips)! PROFESSIONAL EXTRAS (at no extra cost): mixing, monitoring, sound-on-sound facilities and the Norelco stereo dynamic microphone. SIGNAL-TO-NOISE RATIO: 48 db or better. WOW AND FLUTTER: less than .15% at 7½ ips. CROSSTALK: 55 db. HEAD GAP: .00012". AUDIO FACILITIES: completely self-contained, including dual recording and playback preamplifiers, dual power amplifiers and two Norelco wide-range, stereo-matched speakers (one in the detachable lid). For complete specifications, write to Norelco. In the meantime, see and hear the '400'. The recording studio you can carry is now available for immediate delivery.*



**Louis Armstrong**, who uses a pair of 'Continental's' at home and on tour, says: "I've tried lots of tape machines since I got my first one in 1948, but Norelco is the one for me."



**John Brownlee**, Director of the Manhattan School of Music, calls his Norelco "an extremely versatile teaching tool, as it is capable of outstanding, undistorted reproduction."



**Dr. Irene Cypher**, Associate Professor of Education at N.Y.U., based her selection of the Norelco upon performance standards of high fidelity, reliability, versatility and simplicity.



**Norman Singer**, Dean of the Aspen School of Music, says: "A first-rate tape recorder like the rugged Norelco 'Continental' is an essential item for an active music school such as Aspen."

For our new detailed brochure, write:

**NORTH AMERICAN PHILIPS CO., INC**  
High Fidelity Products Division  
230 Duffy Avenue, Hicksville, L. I., N. Y.

*\*Quoted from*



terial will soon reveal the almost total absence of coloration introduced by the AR-3. The sounds produced by this speaker are probably more true to the original program than those of any other commercially manufactured speaker system we have heard. On the other hand, the absence of

\*A reprint of the complete Hirsch-Houck Laboratories' report on the AR-3 speaker system, as it appeared in *High Fidelity* magazine, will be sent on request.

*AR-3's (and other models of AR speakers) are on demonstration at AR Music Rooms, at Grand Central Terminal in New York City, and at 52 Brattle Street in Cambridge, Massachusetts.*

**ACOUSTIC RESEARCH, INC., 24 Thorndike Street, Cambridge 41, Massachusetts**

CIRCLE 2 ON READER-SERVICE CARD

# ACRO SOUNDINGS



## BEST SCHMEST!

A number of people who saw our last advertisement about the new Acro Stereo 120 amplifier took the trouble to write to us and suggest politely that we lay off the superlative generalities long enough to explain clearly and unequivocally *why* we feel the Stereo 120 is so good. So, by popular request, we are devoting one whole column of space (or, at least, what's left of the column) to a listing of technicalia specifica for the Stereo 120.

**POWER OUTPUT...** for those who wish to raise the roof. Each channel of the Stereo 120 will deliver 60 watts at less than 1% harmonic distortion, within 0.1 db from 20 to 20,000 cycles. Ability to deliver full power over the entire audio spectrum means an amplifier won't be overdriven by tone arm resonances, musical subharmonics, or the intense transients that are on many current stereo recordings.

Let's be modest about *Distortion*... we rate the Stereo 120 at below 1% IM at full power, but the fact is that most listening is done, not at 60 watts, but at between 1 and 5 watts. Distortion at these levels is rarely mentioned on specification sheets, because in most amplifiers the IM never goes below 0.5% at *any* power level. In each channel of the Stereo 120, IM is less than 0.1% at any level below 20 watts, which is why its sound is so startlingly lifelike and transparent.

**FREQUENCY RESPONSE** at 1 watt is within  $\pm 1$  db from 5 to 85,000 cycles, yet the Stereo 120's square wave response is virtually perfect from 20 up to 20,000 cycles, regardless of the load that's hung on the amplifier.

**HUM AND NOISE** are more than 90 db below 60 watts output, which is 72 db below 1 watt and is thus completely inaudible under any conditions. Sensitivity is 1.5 volts in for 60 watts out, and the channels are balanced to within 1 db. Damping is variable from 0.5 to 10, *without* the usual increase in distortion, and can be switched off if desired to give a fixed damping factor of 15. The amplifier has built-in metering and test facilities, and its high-rated components (including output tubes) assure long, trouble-free life.

Any further questions?

ACRO ELECTRONIC PRODUCTS CO.  
410 Shurs Lane, Phila. 28, Pa.

## The Beats Have Found A Master



*Maelzel's metronome has been clocking musical beats since 1815, but its days—says conductor Boris Goldovsky—are numbered.*

*Herewith a preview of a new invention: the Tempometer.*

EXACTLY one hundred and forty-five years ago a mechanically minded friend of Beethoven's named Johann Nepomuk Mälzel patented the metronome. Beethoven was delighted with the new invention and within a short time he and most of his contemporaries were marking their scores with metronome numbers. The practice quickly became standard and, as generations of children could bear witness, that inexorable pendulum has ticked down through the ages as the final arbiter in matters of musical speed.

A simple tale, on the surface. But in actuality, some startling problems and a variety of irritations have arisen in connection with metronome indications. While musicians have acknowledged, for example, the impossibility of executing certain heady tempos marked by Beethoven, Schumann, and Verdi—and while Brahms and Wagner, among other composers, repudiated the metronome's usefulness altogether—no one until now has offered any reasonable explanation for the improbability of these historical timings, or has been able to propose any satisfactory substitute for Mälzel's obstinate ticking machine. These were musicians' puzzles, and they waited for a musician to solve them.

It appears, at last, as if a musician has done so, that musician being Boris Goldovsky—lecturer, pianist, head of the opera departments at the New England Conservatory of Music and the Berkshire Music Center, director of his own opera company and of the New England Opera Theater.

Mr. Goldovsky, whose pursuits keep him as deeply involved as any man could be in the basic musical necessity of beating time, discovered years ago that the metronome was of little help to him. "The metronome," he said the other day (in the strong guttural voice which is practically the trademark of so many Metropolitan Opera intermission broadcasts), "the metronome is a very nasty thing." This observation does not express any personal animosity on Goldovsky's

part: he went on to point out that musicians are apt to regard the machine "like a cop, telling them what to do," that its rigid click-click interferes with the fluid phrasing essential to any really musical approach, and that, in any case, it is useless in calculating speeds in public performance because of the noise it makes.

This last restriction, Goldovsky feels, explains the unaccountable metronome marks which many composers in the past have given to their own works. Verdi, for instance, could hardly have brought a metronome to an actual performance of *La Traviata* and estimated the tempo while the opera was in progress. He undoubtedly arrived at his metronomic markings by playing the score at home on the piano, probably singing the vocal lines to himself, with the result which any amateur psychologist might predict: the home performance—ignoring the acoustics of the hall, the natural gravitational pull of an orchestra, and the effort of a professional singer to project the voice with full intensity—was considerably faster than the real thing. "Take '*Non sapete qual affetto, vivo, immenso*,' in the second act of *Traviata*," Goldovsky said. "Verdi's indication is 108 to the dotted quarter, which is impossible. Not even Toscanini, who took the opera faster than anyone, ever did more than approach that tempo. But if you sing this yourself, at the keyboard, you can take Verdi's speed without any discomfort."

Beethoven's case was somewhat different, but the results were the same. "When the metronome was perfected, Beethoven, of course, was completely deaf. He himself couldn't play or hear anyone else play, and it is quite certain that the tempos he indicated came from his mental image of the music. Now, the opening of the *Hammerklavier* Sonata is notated 138 to the half-note, which is so unmanageable you think it

*Continued on page 30*



## snap!

Recall when sound . . . almost any sound . . . was fun? Pure, clear, fresh sounds are part of the fountain of memory. Nothing can ever equal that first awareness of rain on a window, or a distant train whistle, or the silence of falling snow.

But there are some special delights reserved for adult ears. Audiotape, for example.

This tape is unique. It gives you greater clarity and range, less distortion and background noise. Make it your silent (but knowledgeable) partner in capturing memorable moments in sound—from junior's nonstop

chatter . . . to the spirit-soothing music of Schubert. Remember: if it's worth recording, it's worth Audiotape. There are eight types . . . one exactly suited to the next recording you make.



# audiotape

TRADE MARK

*"it speaks for itself"*

AUDIO DEVICES INC., 444 Madison Ave., N.Y. 22, N.Y.  
Hollywood: 840 N. Fairfax Ave., Chicago: 5428 N. Milwaukee Ave.

CIRCLE 13 ON READER-SERVICE CARD

Continued from page 28

# copy cat?



*Not the 'Trimensional' TMS-2! Others have tried to copy its pioneering concept of reflected stereo sound reproduction. But like most successful originals, University's single cabinet TMS-2 cannot be copied—it's patented!*

No other stereo speaker system can offer the flexibility of its deflector doors that enable you to adjust the degree of stereo spread to the room layout and acoustics. No other can offer its full complement of controls that assure balanced output even if the TMS-2 is placed between such acoustically unbalanced decor as a blank wall on one side, drapes on the other. No other can offer the considerable savings in both space and cost that result from its exclusive dual voice coil high compliance woofer. And at the same time, the TMS-2 eliminates the problem of where and how to place two separate speakers for best stereo results. You can place it just about anywhere in the room—even in a corner—and still enjoy fully balanced stereo sound wherever you sit. For a mere hint of how impressively the TMS-2 can actually recreate the breadth, richness and distinction of the living performance right in your own living room, be sure to ask your University dealer\* for a demonstration. And ask him for University's new 'Informal Guide to Component High Fidelity,' or write Desk P-4, University Loudspeakers, Inc., White Plains, N. Y.

\*or write us directly and we will arrange for a demonstration.

Inside the TMS-2 are five high quality speakers operating as two complete 3-way systems. By utilizing the dual voice coil feature of its high compliance woofer, only one bass cabinet and woofer are required to handle the entire non-directive low frequency range of both stereo channels. The mid-range and treble of each channel are covered by an 8" cone speaker and wide-angle horn tweeter respectively... each with its own level control.

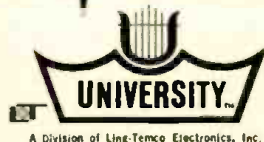

A Division of Ling-Temco Electronics, Inc.

In both styles—Contemporary and Early American—the TMS-2 looks more like a fine piece of furniture than a speaker cabinet. Its beautiful proportions and hand-rubbed finishes will please the most exacting taste. DIMENSIONS: Contemporary—30" x 25" x 12½" d., Early American—30" x 24¾" x 13½" d. NET PRICES: Contemporary—mahogany, \$258.00; blond or walnut, \$263.00; oiled walnut, \$269.00. Early American—fruitwood, \$279.95.

must have been marked by a superman or a madman. But, when you hum it, it seems exactly right."

All of which convinced Goldovsky, nearly twenty-five years ago, of the need for an instrument that could measure not the tempos which composers and performers think they want, but the tempos which they actually take in front of an audience, in a concert hall, under all the stresses of a live performance. What was wanted, in short, was an instrument designed to indicate beats while they occurred, just as a speedometer registers miles per hour while an automobile is moving.

It was seventeen years before Goldovsky met the man—Dr. Oscar Kanner, a North Carolina pathologist trained in music, physics, and higher mathematics—who could produce such a mechanism. Called a Tempometer, Dr. Kanner's instrument has a dial calibrated, like the metronome's, in beats per minute, and it is operated by pressing an electric button (a silent one) in time to the music, whereupon the needle indicates the current rate of speed. Unlike the automobile speedometer's, the needle of the Tempometer holds its position when electric impulses cease, a feature making it possible for the operator to stop tapping at any point during a performance and to mark the dial reading in the score. The fact that the Tempometer is operated by someone other than the performer (or conductor) himself has very little effect on its accuracy, Goldovsky has found. With a little practice, anyone can follow the performer's beat within "a fortieth of a second." The only unsatisfactory aspect of the machine at this time is its price, which is just under \$300. With increased production, it should eventually be available at about \$40.

The implications of the Tempometer are varied and far-reaching. Goldovsky himself has found it invaluable in opera productions, where a large number of people, all with different ideas about tempo, are involved. The singer is shuttled among teachers, vocal coaches, the conductor, and substitute conductors, each demanding something different and each inevitably varying in his requests from day to day. The Tempometer has made possible a new consistency and done much to clear up misunderstandings and disagreements. "In my own case," said Goldovsky, "I discovered that when I played operatic excerpts at the piano I tended to take a faster speed than when I conducted with the orchestra. This was very disturbing to singers, of course, and I taught myself to imagine the orchestral sound more vividly as I was playing the piano. It wasn't long before the Tempometer assured me that I had achieved a satisfactory consistency between piano rehearsals and performances with orchestra.

"Another thing: the Tempometer takes the element of prestige out of rehearsals. Ordinarily, an agreement is settled by

Continued on page 33

CIRCLE 124 ON READER-SERVICE CARD



# Glowing New Sound With Distortion-Free\* Amplification

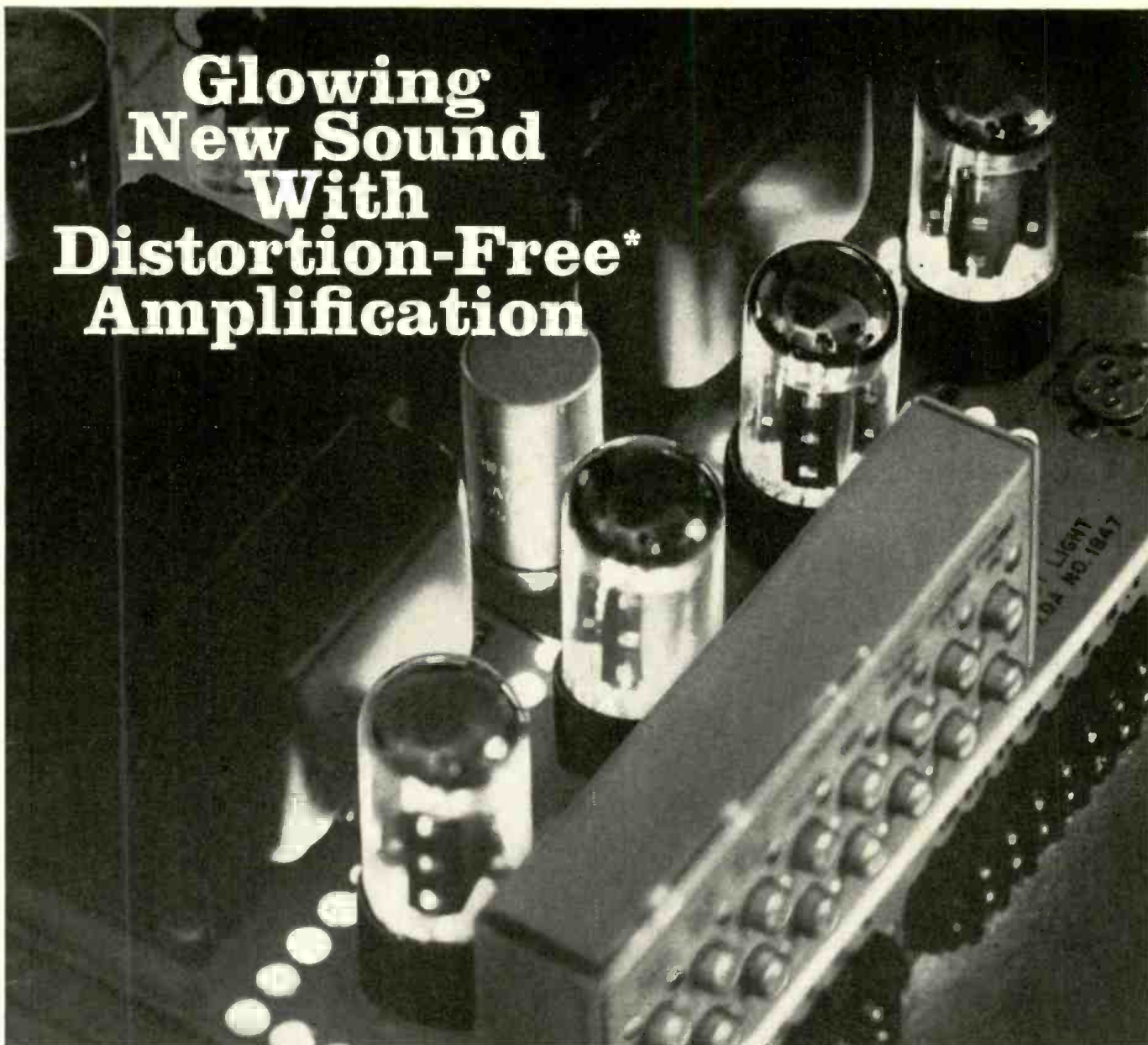

## PILOT 264 STEREOPHONIC AMPLIFIER

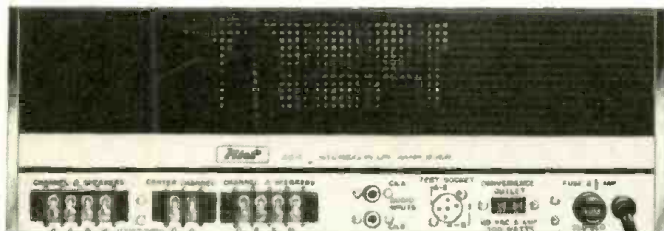

If purity of sound is your goal for your music system, then the Pilot 264 was made for you. Measured using the IHFM standard, at mid-band, power output is 70 watts continuous/74 watts music power. Measured at 25-20,000 cycles, output is 60 watts continuous/64 watts music power. \*Harmonic Distortion at full output using either measurement is less than 0.5%. IM distortion less than 0.3%. Frequency response 10-100,000 cycles. Has Pilot's exclusive "Stereo Plus Curtain-of-Sound" center speaker outputs delivering the sum of channel A and channel B. Complete with brass finish cover...\$179.50.

## PILOT 248 AMPLIFIER-PREAMPLIFIER

The Pilot 264 Amplifier combined with an ultra-versatile preamplifier. Maximum operational flexibility is assured with 15 controls, including scratch and rumble filters, tape monitor and 2 position loudness control. Like all Pilot components, the 264 has a special center speaker connection "Stereo Plus Curtain-of-Sound," delivering the sum of channels A and B, for 3-speaker stereo; or to provide simultaneous monophonic sound in another room. The Pilot 264 is ideal for those who desire a complete stereophonic preamplifier combination. As pictured, complete with enclosure...\$249.50.



For complete specifications on the 264 and 248, write to:  
RADIO CORPORATION, 37-18 36th STREET, LONG ISLAND CITY 1, NEW YORK

CIRCLE 89 ON READER-SERVICE CARD

*peak  
performance...*



*plus unique  
program flexibility  
for the whole family...*

with the RP-40

## SOUNDSPAN™ RECEIVER

*Hi-Fi requirements differ...often within the same family. Dad, the audiophile, looks for a high-fidelity receiver that meets his technical standards. Mom and the kids may want Bach, "Rock", or the ball game...often at the same time.*

Now—ONE unit answers ALL family needs...the exciting BOGEN-PRESTO RP-40 Receiver with SoundSpan combines quality and flexibility. An FM-AM stereo receiver of unsurpassed performance, this revolutionary development makes it possible to channel one stereo program or any two *different* mono program sources — such as tape, AM, FM, records, — *simultaneously*, to different loudspeakers located anywhere in the home.



RP-40 Receiver with SoundSpan \$329.50, less enclosure. Slightly higher in the West.

*A unique Home Music Center...the RP-40 features: Illuminated Tunetabs for quick tuning; Variable Blend-Control; Power Doubler Switch; Precise-acting Automatic Gain Control; Special Mono/Stereo Switching Circuit and many other valuable facilities.*

RP-40 Specifications: *Frequency Response* — 1db, 18 to 30,000 cps; *Output* — 20 watts per channel, 40 watts combined; *FM Sensitivity* — 0.9  $\mu$ v for 20 db quieting; *AM terminal sensitivity* — 1.2  $\mu$ v for .5v output; *Distortion* — less than 0.8% at full output; *Hum Level* — -80db; *Dimensions* — 16" x 13½" deep x 6".

Owning the BOGEN-PRESTO RP-40 with SoundSpan is like having two independent, top quality, high-fidelity systems in your home —for the price of one! It's today's Finest Component System—Designed for Tomorrow's Needs! Write today for free literature.

# BOGEN-PRESTO

Desk H-4 — Paramus, N. J. • A DIVISION OF THE SIEGLER CORPORATION



60-21

CIRCLE 25 ON READER-SERVICE CARD

## THE BEATS

Continued from page 30

whoever is 'boss.' If the singer is boss, the conductor says, 'I am sorry, I will try to do better.' If the conductor is boss, he says the singer is an idiot. But with a scientific tool to refer to, they find out whether or not they are taking the tempo they agreed on the day before. There is now the machine. You don't get angry at a machine.

"We are at the end of an era now," Goldovsky went on. "Both prima donna singers and prima donna conductors are on the way out, and this is good. Music is an ensemble effort—fine people get together to make fine music. Of course, I realize that it will be quite a while before the new Tempometer is accepted by the profession at large. Most musicians have a prejudice against mechanical devices of this sort. They are afraid that somehow the machine will demonstrate that they are doing things incorrectly. It is not easy to convince them that measuring devices are not critics or dictators—they are there simply to tell us what really happens. The young generation of conductors is beginning to realize that they cannot use their judgment sensibly until they know what the facts are. When they see the Tempometer, they are immediately enthusiastic."

One of the most constructive features of the Tempometer, Goldovsky pointed out, is that it will enable composers who hear their works performed to write down in the score exactly what tempos pleased them, or did not please them. "This doesn't mean that these markings must dictate to future performers. Unlike the metronome the Tempometer is not a cop. The score will simply show that, on a certain date, in a certain hall, under such-and-such a conductor, these tempos were taken and the composer liked them. The future performer may choose to ignore the whole thing. But he *may* say, 'Well, the composer liked it—I will give it a try.'"

The benefits of the Tempometer do not all point to the future. Goldovsky has just begun to unearth some curious facts about past recorded performances which may, he feels, shed light on certain ambiguities of musical notation. A tempo comparison of several *Traviatas*, for example, has revealed that some portions of the opera are taken at almost identical tempos by every conductor recording it, while other parts vary tremendously. If these broad disagreements arise from meter notations which are not explicit (6/8 time, for example, often poses the problem of whether it should be conducted in two beats or in six), the Tempometer can isolate the dilemma and point towards a solution.

"We haven't even begun to realize all the things this machine will eventually show us. It's a little like the microscope. In the beginning, people probably peeked in and saw a little dot or something, without knowing what it meant or what its implications were. But look what happened." SHIRLEY FLEMING

# MORE THAN a DECADE of CONTRIBUTIONS to the HIGH FIDELITY INDUSTRY

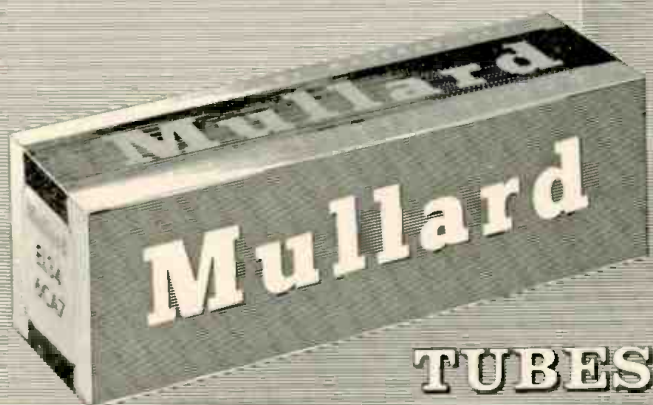

**DESIGNED FOR HIGH FIDELITY . . .  
PREFERRED FOR QUALITY EQUIPMENT**

**INTERNATIONAL ELECTRONICS CORP. 81 SPRING ST., NEW YORK 12, N. Y.**

CIRCLE 65 ON READER-SERVICE CARD



**50-WATT STEREO AMPLIFIER**

Get the most from your stereo tapes, records, tuners, etc., with this top-of-the-line stereo amplifier and control center! Power-packed 50-watts (25 watts per channel); complete tone, balance and stereo /mono function controls; five stereo inputs plus separate monophonic magnetic phono; mixed-channel center speaker output for stereo "fill-in" or wiring sound to patio or other rooms. Superbly styled with luggage-tan vinyl clad steel cover. 31 lbs.

Kit Model AA-100 ..... **\$84.95**  
 Assembled Model AAW-100 ..... **\$144.95**

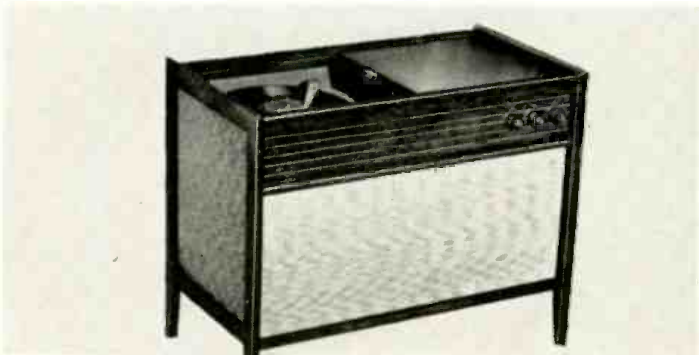

**COMPLETE STEREO PHONO CONSOLE**

Less than 3' long and end-table height; fits both space and dollar budgets! Four-speed automatic stereo /mono record changer has turnover diamond /sapphire styli. Full-range stereo sound is sparkingly reproduced by two 12" woofers, two 8" mid-range speakers and two 5" cone-type tweeters. Solid genuine walnut frame, walnut veneer front panel and matching "wood-grained" sliding top. All cabinets assembled and finished. 70 lbs.

Kit Model GD-31 ..... **\$129.95**  
 Assembled Model GDW-31 ..... **\$149.95**

**NOW ONLY  
 HEATH  
 BRINGS YOU  
 ALL 3!**

- 1. HEATHKIT for do-it-yourself hobbyists.
- 2. HEATHKIT factory-built, ready to use.
- 3. HEATHKIT learn-by-doing Science Series for youngsters.



**look forward to the happy**

**NEW LOW COST STEREO RECORD CHANGER KIT**

For a fine record changer at a budget price, choose this feature-loaded, brown and beige beauty. It has an oversize 11" turntable for better record support, "anti-skate" device to protect your records, jam-proof mechanism for dependable performance, and plug-in cartridge head for easy changing. Plays all four speeds automatically or manually with automatic shut-off after the last record. Assembles easily, quickly with no special tools. Complete with your choice of three different famous-name diamond styli stereo cartridges. 15 lbs.

Model AD-80C, Sonotone 8TA4-SD cartridge ..... **\$37.95**  
 Model AD-80A, GE-VR-227 cartridge ..... **\$41.95**  
 Model AD-80B, Shure M8D cartridge ..... **\$42.95**

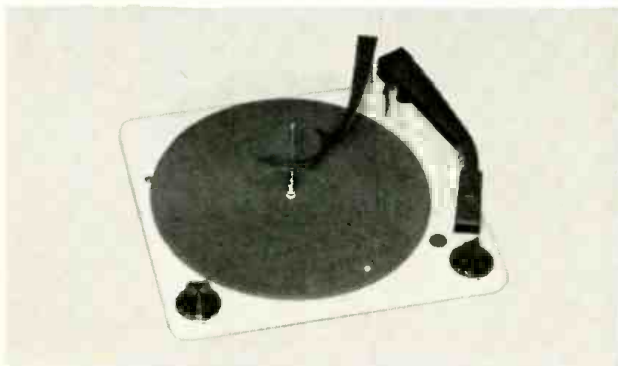

CIRCLE 61 ON READER-SERVICE CARD



**REVERBERATION SYSTEM**

Add a thrilling "cathedral" dimension to listening! The GD-61 adds reverberation "echo" acoustically . . . does not disrupt your present system . . . may be placed *anywhere*. Can be connected to speaker terminals of any radio, hi-fi, TV set, etc. Consists of Hammond-type IV reverberation unit, amplifier, 8" speaker, and preassembled, birch cabinets in mahogany or walnut finishes. 30 lbs.

- Kit Model GD-61M . . . (Mahogany) . . . . . **\$69.95**
- Kit Model GD-61W . . . (Walnut) . . . . . **\$69.95**



**6-TRANSISTOR PORTABLE RADIO KITS**

Your all-summer entertainment companions! Both models feature vernier tuning; 6-transistor circuit; 4" x 6" speaker; prealigned transformers. 6 flashlight cells furnish power.

- Model XR-2P (plastic) . . 6 lbs. . . . **\$29.95**
- Model XR-2L  
(sim. leather & plastic) . . . . . **\$34.95**



**PORTABLE 4-TRACK STEREO TAPE RECORDER**

Plays and records 4-track stereo tape . . . can even be used as hi-fi center to amplify and control tuners, record players, etc. Has 3 3/4 and 7 1/2 ips speeds, tone, balance and level controls, monitoring switch, "pause" button and two "eyetube" indicators. All amplifiers and speakers included. Speaker wings are detachable. Cabinet and tape deck preassembled.

- Kit Model AD-40 . . . 49 lbs. . . . . **\$179.95**

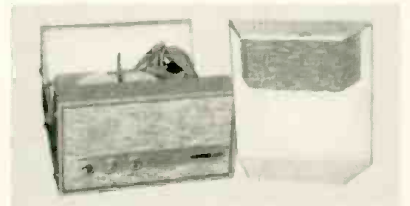

**STEREO/MONO PORTABLE PHONOGRAPH**

Completely preassembled automatic changer plays your favorite stereo and mono records at speeds of 16, 33 1/3, 45 and 78 RPM. Controls give you command of volume, stereo-balance and tonal quality.

- Kit Model GD-10 . . . 28 lbs. . . . . **\$69.95**



**outdoor months with quality sound from Heath equipment**



**HEATH COMPANY** / Benton Harbor 8, Michigan

**ORDERING INSTRUCTIONS** Fill out the order blank, include charges for parcel post according to weights shown. Express orders, shipped delivery charges collect. All prices F.O.B. Benton Harbor, Mich. A 20% deposit is required on all C.O.D. orders. Prices subject to change without notice. Dealer and export prices slightly higher.

Please send me the Free Heathkit Catalog

Please send the following items:

ITEM	MODEL NO.	PRICE

NAME \_\_\_\_\_

ADDRESS \_\_\_\_\_

CITY \_\_\_\_\_ ZONE \_\_\_\_\_ STATE \_\_\_\_\_

Order Direct by Mail or See Your Heathkit Dealer

Ship via  Parcel Post  Express  C.O.D.  Best way

**CIRCLE 62 ON READER-SERVICE CARD**

Rek-O-Kut N-34H Stereotable... \$79.95 net\*



## REK-O-KUT N-34H STEREO TABLE . . . COMBINES INTEGRITY OF DESIGN WITH A CLASSIC BEAUTY OF APPEARANCE !

Once in a decade, a manufacturing firm designs a machine which offers matchless specifications at a price which seems impossibly low. Word-of-mouth spreads the story to dealer and customer alike and suddenly, the new machine becomes the runaway best-seller in its class. This is now happening to the new REK-O-KUT N-34H Stereotable. Here are the reasons why—

**THE N-34H IS SUPERBLY QUIET...**The marriage of the precision-built hysteresis synchronous motor and new revolutionary Rekothane Belt is an engineering break-through which results in the unprecedented low rumble level of -59 db.—beyond a doubt the best ever achieved in a two-speed machine.

**THE N-34H MAKES RECORDS COME ALIVE...**The hysteresis synchronous motor provides locked-in accuracy of rotational speed at all times, regardless of power-line fluctuation and load. Wow and flutter become insignificant at 0.15%. Stereo and mono records, old and new, sound like the original live performance!

**N-34H QUALITY IS HERE TO STAY...**The N-34H is so carefully made it will measure up to the same high specifications, year in, year out. Examine the parts—the turntable shaft machined to aircraft tolerances, permanently lubricated motor bearings, the heavy steel deck-plate which can never warp, the deceptively soft Rekothane Belt which absorbs shock like a cushion and is especially compounded for a lifetime of use.

**THE N-34H... BEAUTY AND PRIDE IN YOUR HOME...**From any angle, the N-34H strikes the discerning eye as perfectly proportioned, significantly beautiful. Why not make this twentieth century masterpiece part of your home decor today?

\*does not include base and arm

### FOR OPTIMUM PERFORMANCE, USE ONLY MATCHED REK-O-KUT COMPONENTS

S-320 Stereo Tonearm with Omni-Balance. 1-hole mounting on N-34H .....	\$32.95 net
Model BN Tapered Base in Oiled Walnut Designed for N-34H .....	\$14.95 net
Acousti-Mounts Recommended for all cabinet installations .....	\$ 3.50 net



# REK-O-KUT STEREO TABLES

REK-O-KUT COMPANY, Incorporated, Dept. HF-41, 38-19 108th Street, Corona 68, New York  
Export: Morhan Exporting Corp., 458 B'way, N. Y./Canada: Atlas Radio, 50 Wingold Ave., Toronto 19

CIRCLE 95 ON READER-SERVICE CARD



## How many new Bell features can you find in this picture?

*It's easy to see for yourself* at least 6 advanced features of this new Bell Stereo Tape Transport for professional quality playback and recording . . . 2 track and 4 track: (1) Record Level Meters on each channel (2) Integrated record-playback Stereo Pre-Amplifier on single chassis, (3) Speed Keys automatically switch record equalization to assure maximum response at both speeds, (4) "Off" Key disengages drive mechanism, (5) Positive Record Interlock with back-lighted indicators as added safeguard against erasure, (6) Mike Inputs on master control panel, always accessible.

And what you don't see here is equally important: Heavy duty 3-motor drive (previously available only on high priced professional machines); electrodynamic braking; wow and flutter less than 0.2%.

Record-playback frequency response of 18-16,500 cps @ 7½ ips, 18-15,000 @ 3¾ ips. New stereo headphone monitor output jack on pre-amp. *Electrical* switching between 2 track and 4 track heads. Styling beauty in walnut grain vinyl-steel matching other Bell components. And a price you can afford.

7 models. Select the model you prefer, at your Bell dealer's, to make your stereo system professionally complete. Or write today, for catalog.

**SOUND DIVISION**

Thompson Ramo Wooldridge Inc., 555 Marion Rd., Columbus 7, Ohio  
In Canada: Thompson Products Ltd., St. Catharines, Ontario

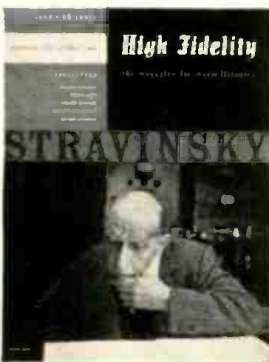
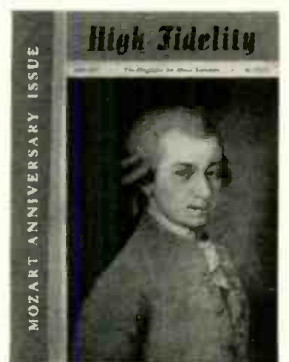
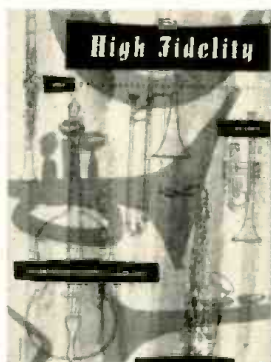
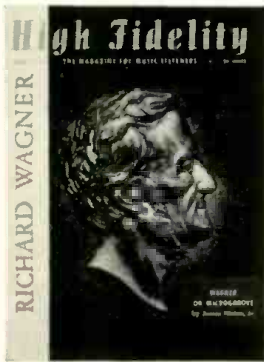
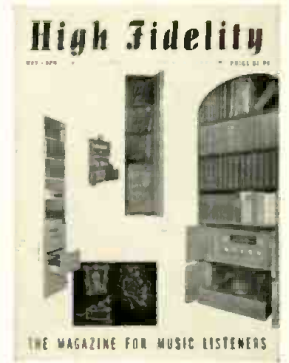

# Ten Years of High Fidelity

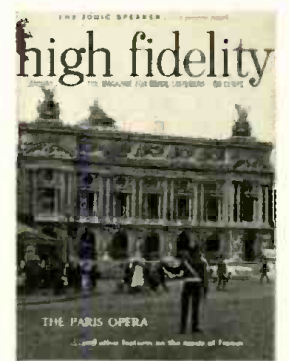
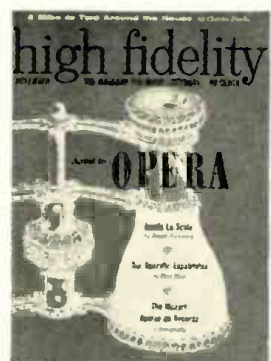
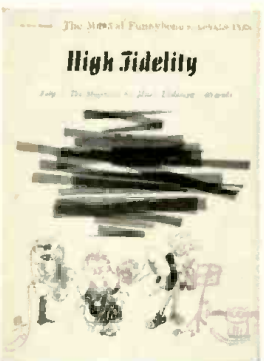



BY ROLAND GELATT

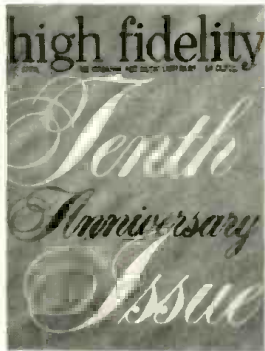
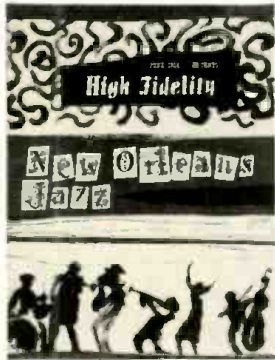
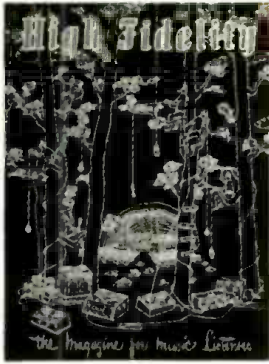

**I**N THE SUMMER of 1951 the editor of a new magazine called HIGH FIDELITY telephoned me from Great Barrington, Massachusetts, to solicit an article. The voice up in the Berkshires (it belonged to Charles Fowler) sounded genial, urbane, and persuasive, but it fell on prejudiced ears. I informed Mr. Fowler that my interests were musical, that high fidelity did not at all enthrall me, that the language of audio conveyed rather less to me than Japanese (I *did* know a little Japanese), and that anyway I was really awfully busy. Three years and several articles later, I joined his staff.

I try to remember this whenever I hear what has become the almost standard comment from the reader newly introduced to HIGH FIDELITY. The comment goes along these lines: "Why, I had no idea that your magazine would interest me. It's about listening to *music*, isn't it? If I had only known, I would have subscribed years ago." The temptation is great for the present editor to wince at this kind of naïveté, until he recalls his own witless attitude of a decade ago.

What I discovered subsequent to that first telephone call from Charles Fowler, what tens of thousands have discovered with me, is that high fidelity exists for music, that it serves Bach and Mozart as nobly as a revered concert hall or opera house does, that it is an adjunct of art and not a species of gadgetry. HIGH FIDELITY, the magazine, has consistently affirmed the musical reason-for-being of high fidelity, the phenomenon. We are, as our cover proclaims each month, a "magazine for music listeners." This does not imply a disinterest in the paraphernalia of high fidelity. We readily admit to the allure which electronic equipment holds for us, and we should not want to minimize our fascination when we try out a new amplifier or a new speaker system. We find this no less reasonable than the fascination a violinist experiences when he tries out a Stradivarius. But a violin of 1720 or a speaker system of 1961 are both merely means to an end. The means are important; we report on them honestly, responsibly, and (we hope) readably. But the means exist for music. It has been our policy at HIGH FIDELITY to keep means and end, electronics and music, in proper proportion.

The vision of high fidelity as music's noble servant is not always easy to sustain. High fidelity has been rather powerfully battered and pummeled in recent years. We have seen the term applied to cosmetics and space heaters and cigarette filters. Worst of all, we have seen it applied to dreadfully unmusical phonographs. A hapless shopper, pondering the purchase of a \$39.95 phonograph, asks the clerk: "Is it hi-fi?" And of course it is. It says so right on the tag. Hi-fi! I confess that I bridle at the sight of this inelegant contraction. It begins to revive my ancient prejudices; it evokes an odor of cheapness, not a vision of art. But the vision remains unsullied, no matter how energetically the supermarket mind tries to cash in on it. A cantata by Bach ringing jubilantly across the wall of a living room quickly restores faith. High fidelity cannot be downed. It is too splendid to be debased.

And now the time has come for celebration. We are ten years

and exactly 100 issues old. The decade has been eventful. Everything has gone up—our circulation, the size of our staff, the capability of recording and reproducing apparatus, the number of loudspeakers in the American living room, the miles of magnetic tape in daily use, the concentration of knobs on control amplifiers, the multiple versions of *Peter and the Wolf*, the production of vinyl for records, the dollars spent on high-fidelity equipment. I hope I shall be forgiven for not documenting the statistics of this steady, sometimes giddy, ascent. We are all aware that high fidelity is an imposing mid-century phenomenon. Figures are not needed to prove it.

One thing has not gone up: the cost of high fidelity. Throughout this generally inflationary decade the high fidelity industry has managed to maintain stable prices while significantly increasing performance. If you examine a 1951 catalogue, you will find that a first-class control amplifier cost \$198 (monophonic, of course, and only 10 watts), that a fine FM-AM tuner was \$205, and that speaker systems (there weren't many then) ran to about \$400. You will pay no more (and often considerably less) for better equipment in 1961.

**A**nd you will pay no more for records. A stereo disc in 1961 carries the same price as the 1951 microgroove; monophonic records today are indeed less expensive than they were a decade ago. And what an incredible profusion of riches we have to choose from! The Schwann catalogue of April 1951 was still a fairly puny affair. The Battle of the Speeds had been decisively won by the 33 $\frac{1}{3}$ -rpm microgroove a mere fifteen months before, and the Repertoire Rush of the 1950s was just getting under way. Today, despite the deletion of much wonderful material, the Schwann catalogue presents an array of recorded music such as was literally unimaginable in the days before high fidelity.

Undoubtedly, too much music was recorded too quickly in the early boom years, but the ideal that impelled all this activity was intoxicating in its implications. It was nothing less than the sonic documentation of Western music—all of it, not just the symphonies of Beethoven and Brahms, but the madrigals of Gesualdo, the concertos of Vivaldi, the operas of Glinka, the lifework of Webern. The documentation proceeds apace, somewhat more slowly than in the mid-1950s but also more scrupulously and with greater attention to musical finish and sonic quality. Quickly, much more quickly than we realize, an incalculable cultural legacy has come into being; the most sublime and universal of the arts is there in vivid performance for all of us to experience.

André Malraux points out that the modern art book, combining the technology of color photography and offset printing, has revealed areas in the visual arts which no one man fifty years ago could possibly have experienced. He calls this new documentation

of the visual arts a Museum Without Walls—a museum far more capacious than the Louvre, the Uffizi, and the Metropolitan combined into one. Similarly, the technology of high fidelity has created a Concert Hall Without Walls (or, perhaps more to the point, a Concert Hall Without Coughs) in which a richer variety of music can be heard than in a lifetime's simultaneous attendance at La Scala, Carnegie Hall, and the Vienna Musikverein.

Again like the modern art book, which can highlight a detail and put a familiar painting into fresh spatial perspective, the concert hall of high fidelity allows us to hear music in a new and provocative way. Which brings us to stereo. The more we listen to this new medium and grow acquainted with its possibilities, the more it becomes apparent that stereo recording and reproduction not only approaches concert hall sound but often transcends it. We are learning that we can hear more purposefully in our living rooms than in a concert hall. Sound can be better dispersed, more judiciously balanced, more carefully highlighted in controlled multiple-channel stereophony than in the uncontrolled spaces of the ordinary concert hall. "How," asks Igor Stravinsky, "can we continue to prefer an inferior reality (the concert hall) to ideal stereophony?" And Leopold Stokowski, in the "Conversations" published in this issue, suggests that multiple-channel reproduction of sound may easily surpass the concert hall norm. This is not to deprecate live music. There are intangibles present at a concert or opera performance which the finest electronic equipment cannot convey: the festivity of the occasion, the magnetism of the performers, the sheer weight of sound resounding in a vast enclosure. But let us give electronics their due. The auditory experience that stereo brings to our living rooms is in some ways inferior but in other ways markedly superior to what we hear at Carnegie Hall or the Metropolitan Opera. The epithet "canned music" no longer applies.

And so we look forward with bright anticipation to our next decade—to the new domain of sound that stereo is opening up, to the new musical experiences that records and tape have in store for us, to the new equipment on which we shall play them. For us, high fidelity is an adventure. Every time we slip a new recording from its jacket or remove a new piece of equipment from its carton, our expectations soar. Sometimes we are disappointed—and our readers will know that we do not hide our disappointment. But often we are filled with that unique elation which only music, full and undistorted in sound, can bring. Yes, it is a fascinating adventure—the music itself, the apparatus that releases it, the people who make it, the places where it is produced. If HIGH FIDELITY Magazine succeeds in whetting that sense of adventure, we shall know that we are on the right track.

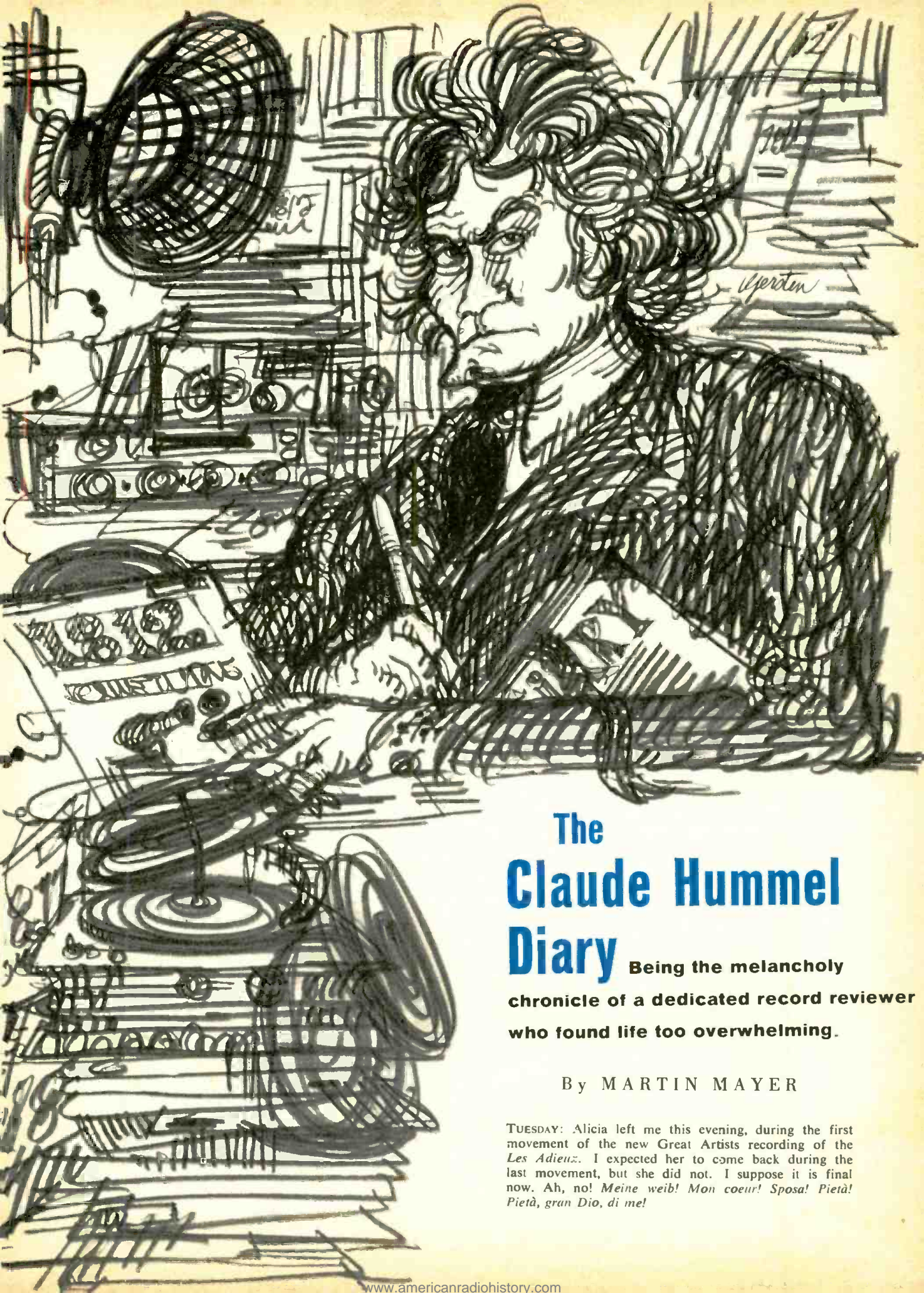

# The Claude Hummel Diary

Being the melancholy  
chronicle of a dedicated record reviewer  
who found life too overwhelming.

By MARTIN MAYER

TUESDAY: Alicia left me this evening, during the first movement of the new Great Artists recording of the *Les Adieux*. I expected her to come back during the last movement, but she did not. I suppose it is final now. Ah, no! *Meine weib! Mon coeur! Sposa! Pietà! Pietà, gran Dio, di me!*

I should go look and see whether she took the children.

I must admit I am surprised. It was not really a bad version of Op. 81a. The pianist is of course a very young artist, but he is doubtless already, as the liner notes say, the most impressive talent ever produced by the Republic of Andorra. He is a candidate for Edwin Fischer's *Meisterklasse* at Geneva next year, and is recording to raise the money for the trip. One wonders, as one so often wonders these days—will one ever hear this name again? Has the boy been paid? Shooting stars—ships that pass in the night! How sad it all is!

Alicia has left me. To whom shall I describe the random thoughts that chase through my brain after ten hours of listening to the phonograph? I must write them now, here, in these pages. . . .

**S**O RUNS the first entry in the Diary of Claude Emmanuel Gaetano Hummel, whose rather mysterious disappearance was noted in amongst the grocery ads in many of the nation's leading papers not long ago. Author of numerous treatises on diverse subjects—ranging from *Folk Influences in the Music of Reger* to *Byzantine Notation in the Italian Quattrocento*—he was probably best known to the public as a record critic and writer of album notes. Now that he is missing and presumed dead, it can be revealed that he was not christened C.E.G. Hummel, though this was, indeed, his legal name in the United States. He had chosen it, he once told me, because the initials made the natural chord of the seventh (H, of course, being the German form for B natural). His real name, strangely enough, was Ludwig Beethoven, and he was descended from the composer's nephew Karl. His strong feeling that he should make a name for himself led him to adopt the *nom d'art* of Hummel.

Claude left no instructions for the disposition of his Diary, which was found at the Weehawken docks. His request that I serve as his literary executor placed no limitations on what I might do with his unpublished writings, and I consider his Diary to be a document of historical and aesthetic importance. I have taken the liberty of editing it, something I had always wanted to do with Claude's prose, and I have eliminated some of the more turgid, morbid, obscene, and libelous passages. The obscene sections may be published elsewhere, depending upon the outcome of negotiations now in progress between one of those brightly illustrated new magazines and the Second National Bank, which is handling the financial end of Claude's estate.

**THURSDAY:** Thirty-one records arrived today. I cut my little finger attempting to tear the new stickum-paper around one of the boxes. I wish I knew where Alicia put the scissors.

Most of today's arrivals came from the Society of Rediscovered Masterpieces. There is a nine-record album devoted to the complete works of Mascalone ("the Prince of Permesso"), and a twelve-record album which is the first installment on a *Gesellschaft* of Ribaldo ("the Gay Priest"). The Mascalone album is covered in goatskin, and the Ribaldo album in chamois. Klee watercolors illustrate the one, and Coptic icons the other. I see that the scores were edited by my good friend Ben

Trovato, of the University of Parma, and that the orchestra consists of seventeen German professors of musicology conducted by a noiseless metronome. The first album of Ribaldo includes the famous set of six concertos written to be played in the Pope's bathroom and scored for *viole da dente*. All honor to the dedicated scholars of Darmstadt-Hesse, who have mastered this fabled, incredibly difficult instrument! Alas, I cannot listen to these records now; there is too much else I must do. Today, I regret that I committed myself to a review for the *Artillery Gazette*, comparing all extant recordings of the *1812 Overture*.

I believe there is a thief somewhere in the apartment. Food is disappearing from the icebox. Alicia would know what to do; I wish she had not left.

**T**HIS entry, I think, is extremely revealing of Claude's basic tolerance. Few of us would sit and listen to twenty-seven recordings of the *1812 Overture*, straight through, yet Claude was willing to do so. Indeed, his thoroughness was such that he would include in his comparative reviews a sampling of acoustical and electrical 78-rpm recordings, out-of-print LPs, and privately made airchecks. All of us, I suppose, rather resented and envied his ability to refer airily to the "Mengelberg broadcast over Radio Sofia in 1934," but on the few occasions when I was able to check back on him he was right—that is, there had been such a broadcast, though the condition of the aircheck was such that one could not really tell much about the performance.

Note also Claude's deep sympathy for the pictorial embellishments that come with record albums. I had occasion to discuss this question with him less than a month before he disappeared. It was a more or less amicable argument. He was not willing to defend some of the horrors that have been in circulation—the little princess that London Records once regarded as a charming illustration for *Kindertotenlieder*, or the syphilitic Beethoven on the old Columbia set of Beethoven Quartets, or the Masterpieces-Suitable-for-Framing that make so many albums look like advertisements for a color-by-number painting set. On the other hand, I was willing to grant that I valued some records all the more for the illustrations that came with them—the early Angel *Homage to Diaghilev* set, among many early Angels; the Erik Nitsche covers for Decca some years back and the recent monochrome illustrations Decca sent along with Handel's *L'Allegro ed Il Penseroso*; some of Columbia's photography; and the nice eighteenth-century woodcuts accompanying the Verdi *Falstaff* and *Otello* sets on Victor. Claude and I disagreed strongly, however, on Klee for Mascalone. I felt that the two came together only because both are fashionable at the moment. I was annoyed, too, by the Signorelli reproductions on the new Victor Verdi *Requiem*—pretty, pre-Raphaelite pictures of the Last Judgment, which are supposed to illustrate Verdi's startling grotesques. Claude thought these reproductions were just fine, and quoted at me Bernard Berenson on the subject of Signorelli. We parted soon, as neither of us liked to waste time with people who are obstinately wrong.

FRIDAY MORNING: Today marks one hundred days since I have last been out of the house, and yet there are still so many, many records I have not heard. Is it me? Is it the turntable? Can it be possible that there are so many recordings? Or have the days become shorter on me? I suspect the atom bomb, but can do nothing. I am dizzy and should rest. I will be free! I will break the rules! Today, though the 1812 awaits me, I shall listen to what came yesterday!

FRIDAY NIGHT (fourteen hours later): Ah, the joy of it! What have I been complaining about? Why do I not kneel and thank the powers responsible for my luck? An afternoon of Mascalone, an evening of Ribaldo—continuously, by musicians who never tire, who will play the same passage over and over again, if you desire to study it, whose intonation is correct, whose phrasing rests solidly on knowledge! The speakers themselves seemed to sparkle (perhaps it was the presence range? I must check). Pure music! How delightful to listen to pure music for all these hours, checking off the difference between a Trovato edition and my own, to rise refreshed! And how few occupations I could have chosen that would have given me the income to buy such records, let alone the time to hear them! I shall not spoil the moment by writing of it further.

I have not heard everything. I would have finished, no doubt, careless of the hour, except that I heard the burglar, and decided to see who he was. After a few moments of confusion, it developed that this was not a burglar at all, but my son Peter, who has grown into a fine handsome lad since I began reviewing records. Alicia left him behind, because she did not wish to interfere with his studies for the College Board examinations. There was a young lady with him, quite pretty, but, I fear, unmusical. She refused to listen to Ribaldo, and fell asleep while I was talking.

SATURDAY AFTERNOON: This morning I heard the last two records of the Mascalone set and all but one of the Ribaldo. They are not perfection, of course; when I read last night's entry in this Diary I realized how little sleep I have had recently. In the third Papal Concerto, I feel certain, a violino piccolo has been snuck in to play certain solo passages.

Now, refreshed, I return to 1812.

FOR those of us who knew Claude, these are highly significant entries. They prove to my satisfaction that he really *did* like that tee-tiddle-tum-faw of Mascalone, he really *did* admire Ribaldo, that most artificial and mannered of madrigalists. Claude was himself, of course, the author of numerous compositions credited to various obscure "masters of the Early Baroque." Like his friend Trovato, he could take the remnants of an old starched cuff, on which somebody had scribbled a few doodles that might have been musical notation, and reconstruct from it a complete concerto grosso. (Rossini bragged he could set music to a laundry list; Claude could make music from a laundry mark.) I had never believed he took it seriously. As Joe Palmer once put it, "One man's meat is another man's *poisson*."

It is pleasant to know that there were moments when Claude, too, had meat. His interests were more specialized than those of most of us, perhaps because he was so jaded. Claude was born jaded—even his features, as an admirer once pointed out, seemed to have been chiseled in jade (by a Zen sculptor, she said). Pieces like the Mozart Concerto K. 271, or Schubert's Second Symphony, or Debussy's *Jeux*, which are reasonably fresh for most of us, were just so much *Scheherazade* for him. Everything bored him, which was, perhaps, the secret of his tolerance.

We used to talk about this aspect of record criticism, Claude and I, this feeling that one has lost one's taste for music. For weeks on end the records revolve on the turntable and the sound issues from the loudspeakers, and one yawns or reads jacket notes or signs Christmas cards or, every so often, checks a score. One feels that there simply cannot be so many poor records, that the fault must lie at home, that the boredom must be in the ears of the beholder. And then a really first-class record sounds forth, and once again reviewing seems a reasonable way to

*Continued on page 152*

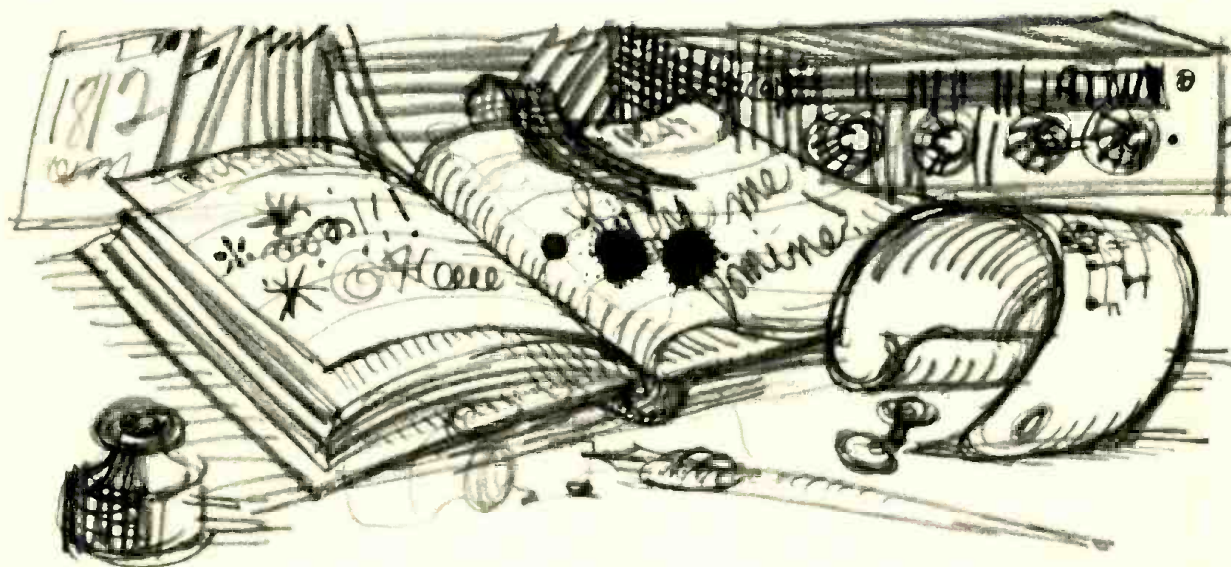

Drawings by Gerry Gersten

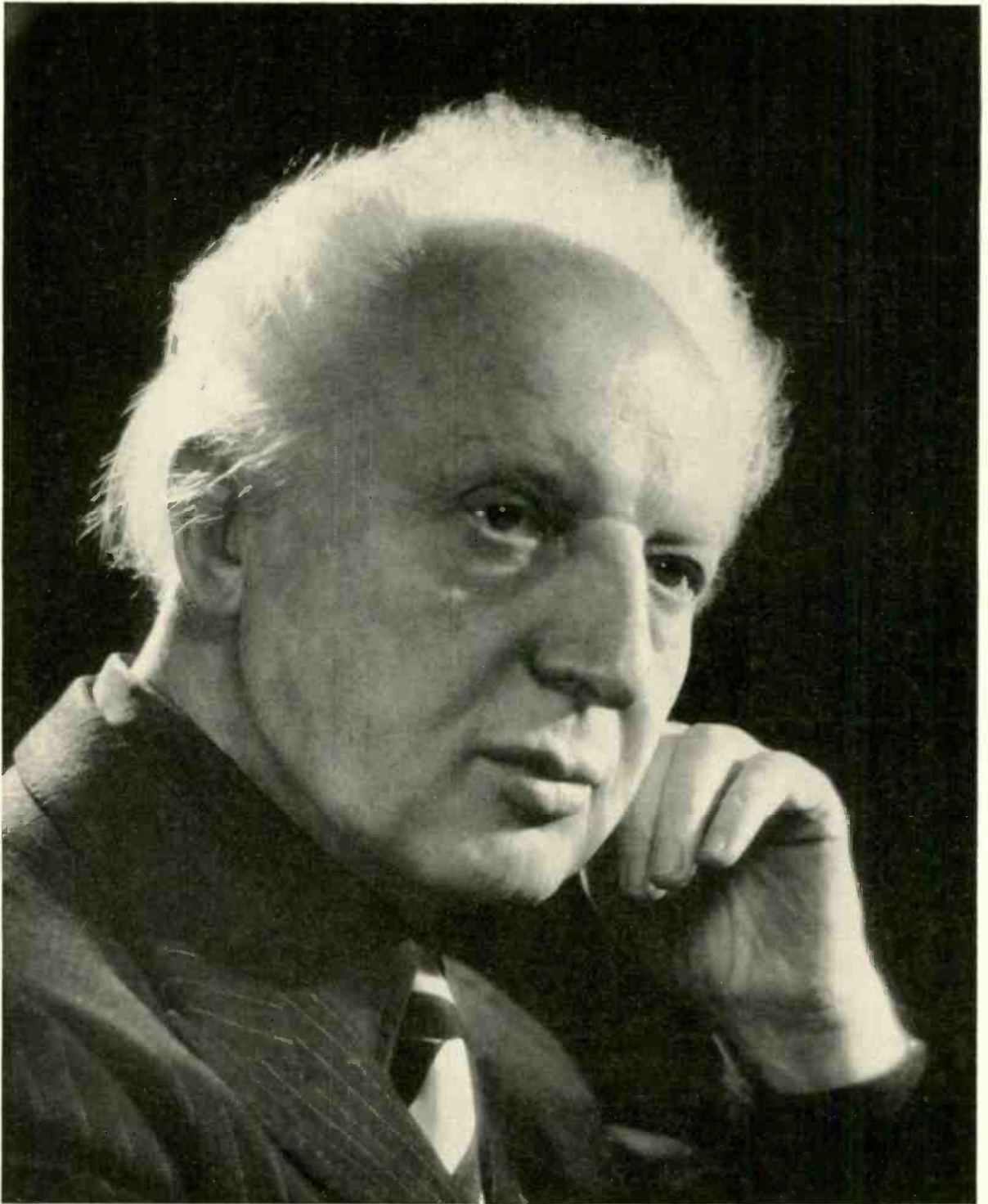

*A dialogue with the*

BY ROBERT C. MARSH



## Conversations with Stokowski

MARSH—Wherever you have conducted, including Leningrad—and Philadelphia, I have heard people talking about how you managed to secure “the old Philadelphia sound” from the orchestra. Do you have in mind a paradigm of orchestral sound?

STOKOWSKI—By no means. The players create the sound, to begin with, and every great orchestra has a distinctive sound of its own. This is one reason why it is so interesting to conduct fine orchestras all over the world. I have no single standard of good sound. This is determined by the music, by the meaning of what the composer has written. There is music in which the sound must be beautiful, very spiritual, and there is other music which must be harsh, even ugly.

MARSH—How do you judge these things—as you study a score, or in rehearsal?

STOKOWSKI—I study a score to know it physically, the notes and form, but I do not go to the first rehearsal with a fixed idea of how it should be played. You have to keep yourself open-minded to hear what the music tells you. A great composition and performance grow and develop, while a score is rather like a letter the composer has written you in a horribly limited system of notation. There are thousands of things which our notation has no means to express, but if you listen you begin to hear the inflections of the composer’s voice. When you play his music you are his intermediary in the transmission of a work of art he has imagined and given

you on paper. But in a performance it must sound as if the players are creating the music at that moment. It is very difficult to achieve this coöperation.

For me rehearsals are more interesting than concerts, but we in rehearsals are fighting against time to realize an ideal. The Philadelphia Orchestra is extremely quick, which is one reason why it is a pleasure to work with it.

MARSH—What was the Philadelphia Orchestra like when you first became its conductor?

STOKOWSKI—It was terribly old-fashioned, stiff in rhythm, with a hard tone and no imagination. It just played notes. German was spoken at rehearsals. I liked having a German orchestra. They were nice people who drank beer, and I enjoyed working with them. The orchestra management wouldn’t let me rehearse in the Academy of Music. We had to play in a small room where we couldn’t properly hear each other. So I started working to make conditions better. [Edward] Bok—a Hollander—waited for me after one concert. “I hear you are having trouble with everybody here,” he said. Bok helped me. He was a fighter and an idealist.

“Why does this man want to change everything?” they asked about me. Gradually I brought in good players, and then it was possible to achieve good musical results. We could play with flexibility. Flexibility is essential if one is to play with feeling. Music is an expression of feeling.

A metronome is a completely mechanical device. It must be for its purpose, which is a message from

*most controversial conductor of the twentieth century.*



## STOKOWSKI

the composer to the performer regarding tempo. Pianists permit themselves flexibility, as they should, because music is a series of moods. No one protests. Yet orchestras are not given this freedom. They are supposed to play metronomically. Why is that? Why can't an orchestra play the way Caruso sang? Naturally there must be a sense of pulsation, but this need not be mechanical. The heart provides a pulse, but the speed of the heart is part of the entire process going on in an individual at a given moment. Music should be an expression of life, with all its variety and contrast, not mechanism. Mechanism is a wonderful part of our modern life, in an automobile, or in an airplane, but it surely has no rightful place in music or any of the arts.

**MARSH**—I know throughout your career you have always been interested in experimenting with orchestra seating. Do you have special seating arrangements for recording?

**STOKOWSKI**—I have a different seating for every concert hall and for every kind of music. Usually, I like the strings on the left and the woodwinds on the right. The woodwinds are extremely important, delicate instruments, small in number. They must be well placed on the stage. This is particularly true since so much symphonic writing makes use of antiphony between the woodwinds and strings (which is, I might add, seldom brought out).

Seating for recording in stereo depends on the character of the orchestration. I have no system. I let the music decide. There are as many variations as there are differences in scoring.

**MARSH**—Can the recording microphone give you the same stimulus as a hall filled with people?

**STOKOWSKI**—Of course. The content of the music is the same, whether or not an audience is present. In fact, when you play to the microphone you are playing to the largest of all audiences. You can give a concert to perhaps 3,000 persons. A record can easily be heard by 30,000, and like the radio it goes all over the world. Besides, an audience coughs and sneezes.

**MARSH**—When did you first see the potential of records and broadcasting for creating a larger and better-informed musical audience?

**STOKOWSKI**—I saw the value of recordings at the start but with great dissatisfaction with the results. [Stokowski made his first recordings in 1917 and was broadcasting Philadelphia Orchestra concerts to four continents, via NBC, in 1929.] There are thousands of persons in remote places who can know the message of music only through records and radio. I wanted to reach them. We made our first records by the acoustical process. They were awful. The players had to be pushed tight into an enormous horn. Since the double bass did not record at all, the tuba had to supply the bass. Musically this was very bad, and at first I refused to make records because of the distortion of the sound. Then I realized that this was a stupid attitude. The thing to do was make records and try to make the method better. We experimented with different procedures, but acoustic records were never really good.

Then came the application of recording of [Heinrich] Hertz's discovery of electromagnetic waves. There used to be a Hertz Institute in Berlin—I studied there about 1929—but later Hitler smashed it up. After electrical recording began, I felt progress was sure to go on.

**MARSH**—How do you prefer to work when you are making a recording?

**STOKOWSKI**—In five-minute sections. It is much easier for the men that way, and there is always a good spot to stop, where you can splice, or perhaps there may be a pause in the music. They play, rest, play, rest, and this way they are fresher and play better. But I don't rest. I go and listen and make a list of all the things that must be changed. The second time you usually have it, but sometimes we must try again—three, four, even five times. Then we can go on to the next section.

It fatigues players too much to go straight through a work. Of course you must do it this way in concert, but in concert something always goes wrong. You know it, and of course the player who is responsible knows it too, but you cannot stop. You must not think of recording in terms of a concert. In recording nothing is ever done less than twice, and this is why a recording done by an honest person is always better than a concert performance.

I leave nothing to the engineers. When we have done each section of the work satisfactorily, I supervise the splicing of the sections together, and then I play the work through to see if the total meets with my approval.

**MARSH**—What was your first encounter with stereo?

**STOKOWSKI**—I first heard true stereo in the Bell Laboratories where I used to study. Harvey Fletcher made experimental stereo recordings with several channels. A later development of this were the recordings for *Fantasia*, which were made on eighteen



channels. The experiments in the Bell Laboratories were useful for *Fantasia*, which was on a much bigger scale, but working in *Fantasia* was not very helpful when I started to make three-channel stereo for the home. It was not a new experience for me, however, after what I had learned in the Bell lab.

New processes always bring new problems. We have at present two extremes. We can record on three channels and reduce to two, trusting that the sound will blend in the listening room. Seurat and the other pointillist painters used a similar method in which what we experience is actually a product of the artist's work plus the distinctive mechanism of our eye. The picture is really a highly complex arrangement of tiny dots of color, but when we look at it our eye cannot resolve the dots as such but sees colors that do not actually exist on the canvas. So in two-channel stereo the speakers, when properly placed, give the illusion of a panorama of sound with instruments in the middle, when really there is nothing there.

At the other extreme we do the blending in the laboratory and have something rather like monophonic sound coming from two speakers. It is going to take time to find a method midway between these techniques that expresses music with eloquence, clarity, and balance.

I'm in favor of four-track stereo. Fifteen years ago in Holland when I was conducting the Concertgebouw Orchestra, the engineers of the Philips company asked my consent to record the rehearsals and the concerts stereophonically on four tracks. I was delighted to study with them in their wonderful labo-



*Listening to Fantasia from a projection booth.*

ratory outside Amsterdam where they do both commercial and pure scientific research. There was a rehearsal every morning and we would play it back in the afternoon. The engineers put a speaker in each corner of the room and used very low output. We could sit anywhere in the middle. It was a marvelous effect, completely nondirectional—like being surrounded by music.

Of course some people would say, "but it's not concert hall sound." This is a completely meaningless criterion for music heard in the home. A concert hall has thousands of cubic feet of interior space. A living room has only a few hundred. They can never sound the same. I travel very much. I like to travel. It is more interesting to make friends with local audiences than to stay in one place all the time. I can tell you with personal knowledge that no two concert halls in the world sound in any way the same. I am not even certain that the way we hear in a concert hall is the best and only way to listen.

MARSH—What do you feel is the contribution of stereo to music in the home?

STOKOWSKI—The fact that the violins are on the left and the basses on the right is of no importance. Stereo permits greater clarity than ever before, and it can deal with large amounts of volume without distortion. Solo instruments can be heard with proper prominence. They take on a kind of relief. Stereo provides a far truer musical experience.

MARSH—What factors do you experience when you hear a playback of one of your own recordings in the studio?

STOKOWSKI—When I listen, I am sometimes terribly distressed with the way I conducted the work. When you conduct you are outgoing. When you hear you are receiving, and you hear what is imperfect. I learn a great deal from my records, but I start by being unhappy and distressed.

MARSH—Do you listen to recordings made by other musicians?

STOKOWSKI—I spend part of almost every night listening to recorded music. I am very interested in the music of Asia. I recently compiled for publication [in the November 27, 1960 issue of *This Week Magazine*] a list of recommended recordings that grew entirely out of my listening at home.

MARSH—I noticed that, although the editors mentioned a few of your discs, your list included none of your own recordings.

STOKOWSKI—That was not false modesty. After I have worked at a record and made it as fine as I can, I seldom listen to it again. *Continued on page 162*

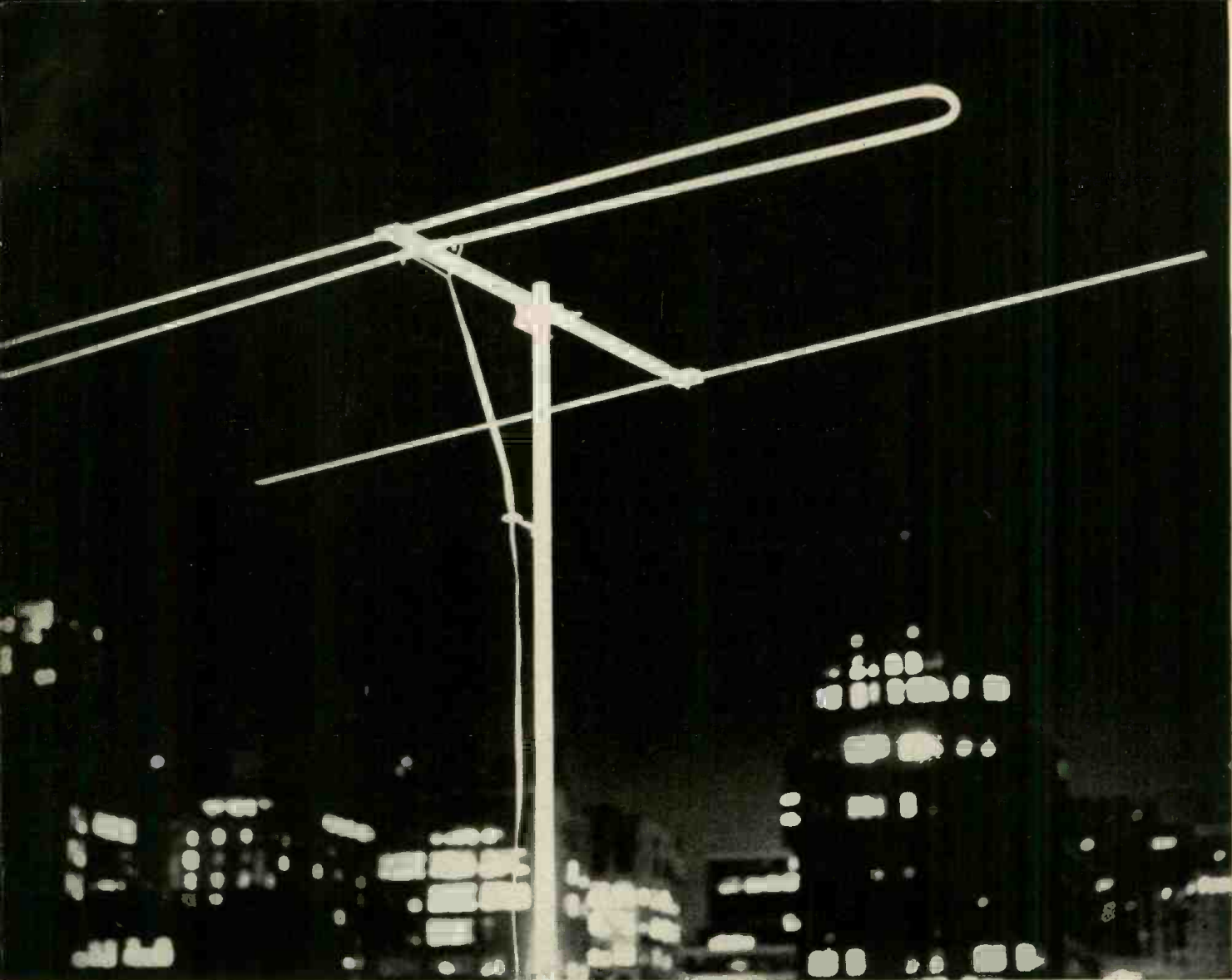

Photo by Peter Eco

# FM's Next Chapter

Major Armstrong's problem child, coming out of the kinks, now is threatened with a split personality—stereo. What are the prospects?

BY NORMAN EISENBERG

**A**T LAST COUNT, there were in this country nearly eight hundred commercial FM stations broadcasting to some 15,500,000 sets installed in more than twelve million homes—which means, roughly, that today one-fourth of American families own at least one FM receiver. The statistics startle; but they startle even more when one adds that in 1956 the number of FM station authorizations had fallen from 1948's thousand plus to a low of 546, while the

sales of *all* types of receivers dropped in less than a decade from the 1946 high of 13,052,000 units to something less than half that number. The saga of these years is susceptible to various explanations, but they all lead to the same conclusion: in 1961 radio in general and FM in particular are showing signs of recovery from near-doom to near-boom.

The interesting question, of course, is whether the present glow will be sustained or whether it will

prove simply another flash among the megacycles. Experts disagree on the general state of the nation's economy, television offers its acute competition, and relations between the broadcasting industry and the FCC could hardly be described as wholly amicable. One fact, however, stands out as auguring for a bright future—the growing realization that there's money to be made in FM. More and more the industry has come to realize that high quality programming, transmitted via wide-range, noise-free high fidelity FM, can prove lucrative even while satisfying within reason the tastes of selective listeners (not to speak of the secret hankerings of broadcasters themselves, many of whom are eager for something better than AM radio and TV if only it won't cost their shirts). Apparently, the something better has not cost any shirts but rather put new ones in the bureau. As *U. S. Radio*, a publication for the broadcasting industry, puts it, "The sweet smell of success has induced an abundance of new investments in the [FM] medium in the form of new program services, networks and groups; new national representation; new FM set models; new associations."

Some of these developments, specifically geared to FM programming and FM audiences, are indeed unique. Thus, the chain of "Heritage Stations" serviced by International Good Music, Inc., which supplies an "automated program service" (pre-recorded tapes and the equipment on which to play them) to several small broadcasters who—with virtually no music library and very little staff of their own—then can go on the air and reach local FM audiences. Yet another phenomenon of FM is the program-magazine placed on a regional and paying basis. Thus *Playback* is FM's answer to the *TV Guide*; for example, it sandwiches local program listings between capsule record reviews and brief pieces on musical events and personalities. *Cue Magazine*, long regarded by many New Yorkers as little more than a guide to Gotham, now devotes several pages each week to a conscientious listing of the selections (including performing artists and, when applicable, record labels) to be heard on some eighteen metropolitan FM stations.

Telling as it is, monetary success does not tell all. For alongside the revenue-reaping stations and the various services that have sprung up about them are nearly two hundred noncommercial FM stations, classified by the FCC as "educational FM." These stations make no money. Many operate from a university campus; some, like New York's WNYC, are financed by local government funds; at least one, WBAI, is making a heroic attempt to become a listener-supported station, while two of its sister-stations in the Pacifica Foundation—KPFA in Berkeley-San Francisco, and KPFK in Los Angeles—already have succeeded in doing so. Plainly, there is a public demand for good music and good sound that has alternately stimulated and bewildered both the broadcasting industry and the FCC.

Stereo figures in this growing interest in two ways. For one thing, stereo records and tapes have helped stimulate a new awareness of both program content and acoustic techniques in music reproduced in the home. It is, apparently, a short step from buying a new stereo system to sensing the superior sonic attractions and high-level programming of FM radio. In fact, more than half of the some two million new FM receivers estimated to have been sold in 1960 are combined with stereo phonos or are high-fidelity tuners designed to accompany component systems. In short, an interest in FM and an interest in high quality sound reproduction via records and tape seem to go hand in hand.

If stereo has stimulated the growth of monophonic FM, what will stereo FM do? Or rather, how will it do? Most broadcasters simply are waiting for the go-ahead sign. Roger Coleman of New York's WABC holds that while AM-FM stereo can hurt, rather than promote, stereo broadcasting, some form of multiplexing in which both channels can be transmitted via FM would definitely be worthwhile. This view is readily seconded by officials of suburban and rural stations. A. J. Detzer, head of WGHF, Brookfield, Connecticut, asserts that most independent FM stations "would welcome stereo via FM multiplex" and estimates that at least 25% of their listeners already own, or would be willing to get, the requisite second reproducing channel (amplifier and speaker) for listening to stereo.

If stereo, via FM multiplex, represents FM's last point of break-through, something that could provide long-term assurance of the continued growth of FM broadcasting, to say nothing of the increased enjoyment afforded the home listener, the new technique itself has yet to make its own break-through. Officially, that is. Technically speaking, no less than six different multiplex systems have been proposed. (A description accompanies this article, on p. 51.) Somehow, through the welter of claims and counter-claims for each, the contest—at least from a high fidelity point of view—seems to devolve to two systems. And hereby hangs a new twist to an old tale or, rather two new twists.

One of the basic problems in deciding on multiplex as a means of transmitting the second channel for all-FM stereo is the fact that for some years now the multiplex technique has been used for transmitting on a private subscription basis to stores, factories, banks, and suchlike what is politely called "functional" or "background" music. These establishments can thus avoid the necessity of investing in public address equipment and the trouble of changing records or even tuning in a normal radio. Whatever one's views on the desirability of constant low-level, low-fidelity music in public places, the fact is that this multiplex operation has meant an income for the purveyors of the service and its related equipment—to say nothing of the support it has given to some FM stations which continue to broadcast high quality programs on their regular,



*Unique to FM broadcasting is this automated tape system supplied, with recorded programs, by International Good Music, Inc. System is built around modified Ampex units. Top decks play music; deck at lower left plays local commercials and announcements; remaining deck is a stand-by unit. Timing and switch controls are housed in center console.*

home-received frequencies. Consequently, while everyone agrees that stereo via multiplex is the thing, not everyone agrees on what *kind* of multiplex. The basic conflict is between multiplex that will provide stereo and the subscription music service, and multiplex that will provide stereo exclusively.

Proponents of high fidelity have been more or less committed to a system (devised by Murray G. Crosby in 1953) that provides stereo only, since such a system has been, to date, the only one considered capable of permitting full-fledged response on both channels as well as allowing monophonic response in non-stereo receivers. It is, in short, a system in which musical integrity is not compromised by technical gimmickery. Multiplexing itself—like FM—originated with Major Edwin Armstrong, who in 1935 described his experiments in transmitting independent signals on “subcarrier” channels that could be made part of one basic carrier frequency. Since then, the principle has been used as the basis for several systems, of which Crosby’s and some others figure in the present controversy. Although the Crosby system has been used on a temporary FCC permit, none of the systems has been approved for regular use.

To help decide the issue, the National Stereophonic Radio Committee (a group set up by the Electronics Industries Association) last summer conducted tests for each system, with the FCC “observing”—presumably the most important single witness, since from the FCC must come the final decision on which system, if any, will be adopted for FM stereo. The test broadcasts originated from Pittsburgh’s KDKA and were received some fifty-five miles away in Uniontown, Pennsylvania. According to NSRC member Daniel von Reckling-

hausen of H. H. Scott, Inc., some thirty-five engineers were on hand representing a variety of organizations. “It was a real engineering pool,” recalls Von Recklinghausen. “The spirit of cooperation prevailed rather than that of company partisanship. Often, members of different organizations worked on the same team; patently they were interested in getting at the truth rather than promoting one system over another. FCC personnel also pitched in.”

So far, so good. Apparently, the warm July sun and the aura of the Muse combined to make a scientific adventure out of what easily might have been a six-way technical Armageddon. As it turned out, things were pretty much simplified to a two-way disagreement.

While other systems seemed to move into the background because of deficiencies as to either full stereo or full fidelity, the spotlight fell on the almost identical approaches developed by Zenith and GE, combining AM and FM techniques, as the major contenders against the Crosby system. According to one view, the fact that the second channel of both the Zenith and GE systems is amplitude-modulated need not concern the high-fidelity-minded listener. These systems reportedly retain all the advantages of FM transmission, and yet require only a relatively simple, low-cost adapter.

An opposing view was taken by Crosby spokesman Leonard Feldman, who pointed out that because the second-channel signal will be AM once it is detected, the detection process in the receiver would have to be accomplished in the most rigorous, completely linear fashion to avoid excessive distortion. Feldman estimates that seventy-five per cent of existing FM receivers, including component high-fidelity tuners, thus would not be able to handle that second-channel signal.

The main burden of Crosby’s argument is contained in a detailed treatise, attached to the test results, reposing in FCC headquarters in Washington, known as Docket No. 13506, and reaching the proportions of a good-sized city telephone directory. Crosby’s essay is sprinkled with phrases like “misleading,” “inaccurate,” “falsehoods,” and “very poor control of the measuring techniques.” The main target seems to be the GE system. The NSRC panel’s findings on signal-to-noise ratio are challenged as well as the conditions that surrounded the tests, such as transmitter noise and poorly adjusted receivers. Furthermore, Crosby denies the premise that the signal strength used in the field tests is representative of the weakest (realistic) signals, such as 3 microvolts, that characterize FM reception in most home sets. Crosby engineers, in fact, conducted tests with reduced signal levels; it is alleged that in these tests the Zenith and GE systems produced poorer signal-to-noise ratios than did the Crosby system. These test data were not made part of the official results because the FCC ruled that the signal levels used in these “supplemental tests” were not strong enough.

Meantime, and independently of all these tests, a team of RCA engineers undertook to analyze the various proposed systems. Their findings, summarized in another document of formidable proportions, suggest a system that is, essentially, a modified Crosby system. In general, they took a dim view of the other systems the NSRC had tested.

There the issue stands joined. The undeniable attractions of the Zenith or GE system and the spirited disagreement over the test results would suggest that the logical thing to do is to run new tests, between the finalists as it were. In its present state, it is unlikely that the FCC will take kindly to such a proposal despite its admission of "widespread interest in FM stereophonic broadcasting." Will, then, a decision be made on the basis of existing test results and their challenged validity? No one, least of all the FCC, has the answer.

Stereo or no, FM in the Sixties will face other challenges as the medium grows. Many ambiguities arise from the contradiction that while FM has become something of a cultural entity, it still remains an unsevered part of the broadcasting industry as a whole. A broadcaster's main concern is to get on the air and stay on. There is the danger that this end can take precedence over what he goes on the air with, or how. FM sound, while infinitely better than AM or TV sound, is today uneven. The tendency for some stations to overmodulate, in an effort to simulate high-fidelity sound or to supply a signal stronger than their neighbor's, is responsible for distortion. (It also happens to be a violation of FCC regulations, although the FCC is not always the most alert body to take measures.) As part of the emphasis on the means of transmission rather than on reproduction, it *Continued on page 157*

## SIX WAYS TO TWO CHANNELS

THE six systems of multiplexing tested by the National Stereophonic Radio Committee in July 1960 were designated thusly: 1) Crosby; 2) Calbest; 2A) Halstead; 3) Percival-EMI; 4) Zenith; 4A) General Electric. These designations are a clue to the similarity of some systems. Thus, Calbest and Halstead are related; Zenith and GE are virtually the same; Crosby and EMI are in classes of their own. Briefly, the Crosby system uses an "A-B" signal on the main FM carrier, and an A-B signal on the subcarrier. With a suitable adapter, an FM receiver provides separate A and B signals for stereo; without the adapter, the same FM set provides ordinary mono reception. There is no room on the subcarrier for any other signal, nor is there room for a second subcarrier. If used for stereo, then, the Crosby system rules out subscription music to industrial and business establishments. On stereo, there was some reduction in signal-to-noise ratio, but channel separation was found to be quite good, with each channel able to provide the normal FM response of 50 to 15,000 cycles. Distortion, in these tests, varied from 0.4 to 7%, although a Crosby spokesman points out that the latter figure was a pure freak caused by maladjusted receiving equipment. It is said that normally, and in other tests (privately conducted), distortion never rose above 2%.

In the Calbest system, the main FM carrier carries a stronger A+B signal (70% modulation as compared with the 50% of the Crosby system), but the subcarrier frequency transmits B channel signals only up to about 8,000 cycles. Thus, response above 8,000 cycles

is not transmitted (or received) in stereo. With this limited channel separation, an FM set equipped with an adapter (other than the type used in the Crosby system) can furnish stereo; without the adapter, it provides mono reception. In stereo, the reduction in signal-to-noise could be as much as 20 db (objectionable) because of the different pre-emphasis used on each carrier frequency. The over-all response of the system was not adequately measured; as with the Crosby system, the results obtained (0.5 to 3% distortion) were suspect because of reportedly poorly adjusted equipment. In any case, the Calbest system permits the use of an independent subcarrier for transmitting private subscription programs.

The Halstead system is quite similar to the Calbest, except for a somewhat different mixing of signals at the transmitter and receiver. The main channel carries a "2A-B" signal; the subcarrier, a 2B-A signal. This type of mixing permits a simpler adapter for the receiver, but it does not provide as much channel separation as do the other systems and reportedly runs the risk of mixing noise from the subcarrier into the stereo channels, particularly if the receiver is at some distance from the transmitter.

The Percival-EMI system has been characterized as "pseudo-stereo." In it, the main channel is modulated with an A+B signal, while the subchannel carries a "steering signal" that actuates a remote, automatic differential volume control. This control varies the signal level between left and right channels to create a "signal intensity difference" that is intended to provide a

stereo effect. The system, similar to the once tried "perspecta" system for movie stereo, is somewhat like playing a mono record and, as Daniel von Recklinghausen, one of the engineers present, puts it, "making your own stereo by operating a balance control to create the illusion of some sounds reaching you from one direction or the other." Although in the tests this system boasted the best signal-to-noise ratio, it was agreed that it provided the least convincing form of stereo. Much of the reverberant or ambient quality of stereo was lost; the music "lacked life." A very complex system, it permits two additional subchannels for background music services!

A novel variation was represented by the Zenith system in which AM and FM techniques were combined. The main channel again carries the A+B signal, but the subchannel carries an A-B signal that is impressed on it by amplitude modulation. The over-all signal thus obtained (that is, the AM modulated subcarrier) then, in turn, is impressed by FM onto the main carrier. The over-all signal is transmitted by FM and received by FM sets. In the tests, this system had excellent separation to 15,000 cycles and very low distortion. It permits the use of an extra subchannel for background music service with no appreciable interference between that channel and the home-received stereo signals.

The system proposed by GE is very comparable to Zenith's except for minor variations. In fact, the field tests indicated that the GE system had even less distortion and less interference from the subchannel carrying background music.

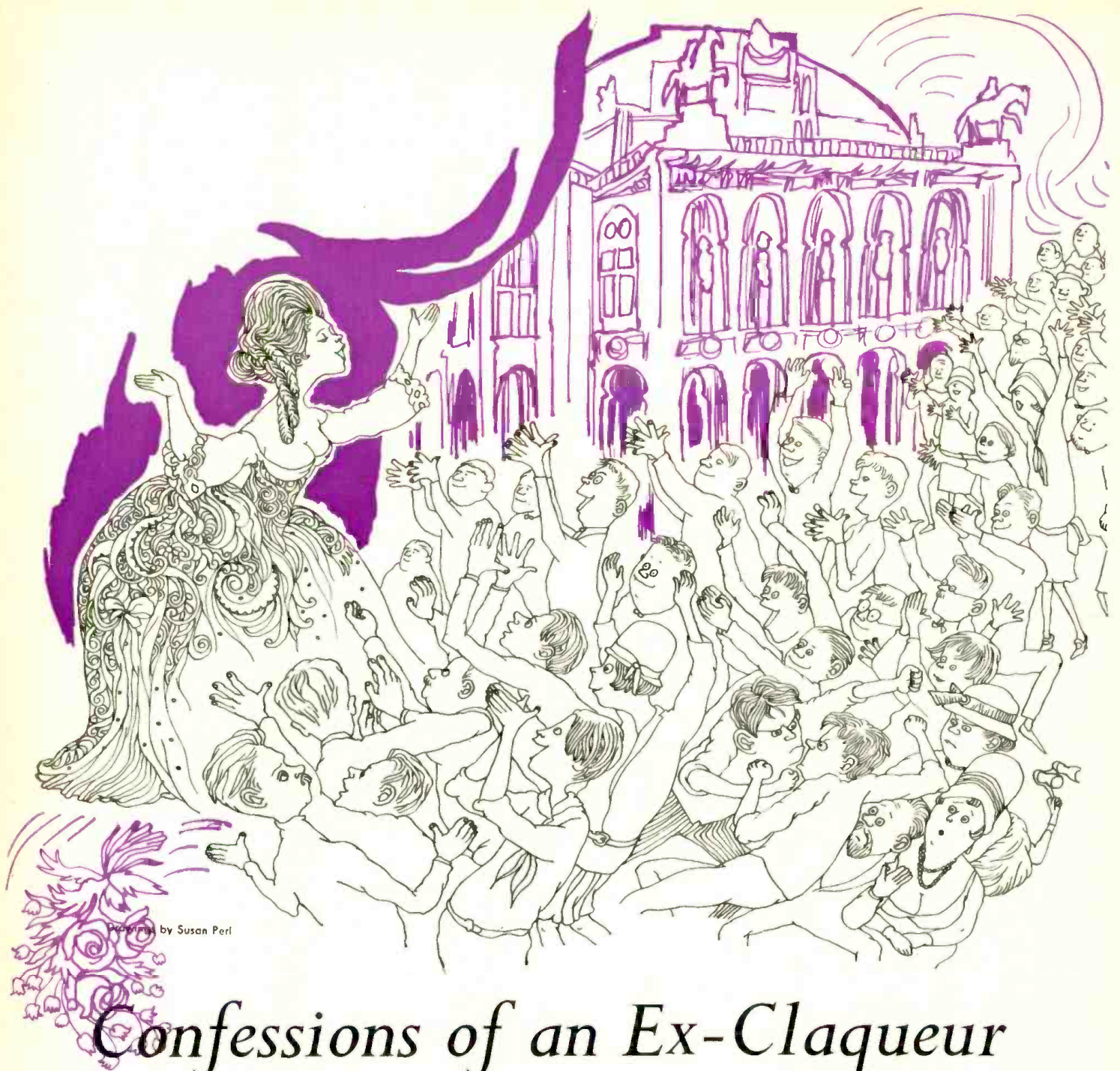

Illustration by Susan Perle

## Confessions of an Ex-Claqueur

**The word "claque" has an ignoble sound to today's ears. It should not have, says the author, himself a sometime claqueur with a most distinguished company.**

BY JOSEPH WECHSBERG

SOMETIMES I think that the years which I spent in the claque of the Vienna State Opera during the late Twenties were the golden epoch of my life. Nostalgia may of course have something to do with it. "The remembrance of the past is infinitely more agreeable than the enjoyment of the present," wrote Lord Mount-Edgumbe (1747) in his *Musical Remi-*

*niscences*. I was young then, and looking back I remember great performances with many "golden" voices. Listening now to some older recordings, I realize that these voices were merely gold-plated.

Still, it was a wonderful time though it had certain drawbacks. My operatic enthusiasm was not matched by financial solvency. There were evenings

when I had to choose between a couple of sausage rolls and a fourth-gallery standing room ticket. When Richard Strauss or Franz Schalk conducted and Leo Slezak or Maria Jeritza sang, the love of opera triumphed over the pangs of my stomach. But at long last I solved the dilemma between food and music by joining the claque.

I have joined other noble outfits since then, among them the Army of the United States, but none had the exclusivity of the Vienna claque. You were not born into the claque as into the House of Lords, and you weren't accepted just because you had gone to the right school; some claque members had a very spotty scholastic background. But all lived up to Hector Berlioz's famous definition of the perfect claqueur in his *Evenings with the Orchestra*. We were "educated, shrewd, cautious, inspired."

Inspiration was the most important component. Joseph Schostal, the great claque chef, might forgive a wrong cue but never lukewarm enthusiasm. He was a tall baldheaded man with powerful shoulders, strong palms, and a booming voice. His high-minded principles were remarkable in a métier not famous for lofty morals. Schostal had come from Brno (Brünn), the capital of Moravia, whose opera house was a famous jumping-off place for young singers who later became famous; Slezak, Jeritza, and Alfred Jerger were among those who had jumped off from there. Schostal's family owned a renowned textile factory. Young Joseph had come to Vienna to study medicine but like another young Joseph he had become enchanted by a sort of Madame Potiphar, the Vienna Opera, with which he carried on a passionate love affair until his untimely death, fifteen years ago in New York. The Schostal family, shocked at Joseph's infatuation, promptly disinherited the opera lover. Every year at Christmas they sent him material for a new blue-serge suit. Schostal had at least a dozen of them, his only links with home.

Schostal had uncompromising ideas about the art of subtly engineered applause. He claimed that genuine applause cannot be bought but must be earned. He would take money from the artists but always made it clear to them that he was under no moral obligation to deliver applause unless the artists deserved it. The volume of applause would range from a mild shower after Cherubino's "*Non so più*" (appropriate with the style of Mozart) to a dramatic tumult when the tenor in *Turandot* finished "*Nessun dorma*" with a perfect high C.

"Applause must always be genuine," Schostal would say. "Genuine applause gives the artist more confidence, the audience greater excitement, the per-

formance a special gloss. It turns a mediocre evening into a great one. The claque makes opera 'grand.'"

Schostal knew that there existed outfits in other cities where money would buy applause even after a cracked high C. For such rackets he had only contempt. He often talked about the great tradition of the claque over his beer in the back room of the Peterskeller, a smoke-and-goulash-scented joint across from the State Opera patronized by cabdrivers with doubtful manners, ladies with doubtful morals, and the members of the claque—some with both doubtful manners and morals.

The institution of the claque, Schostal would remind us, was older than opera itself. Opera dates only from the sixteenth century, but the claque was already known to the ancient Romans. Nero, an early status seeker, had a "body of hired applauders." Owing to their exalted pedigree, the claqueurs in eighteenth-century Paris were called *les Romains*, but among each other they referred to themselves as *chevaliers de lustre*, aware of their ability to give brilliance and glamour to a lusterless performance. In 1837 it was proposed in Paris to introduce the claque officially in the opera houses of France, England, and Italy in order to educate innocent audiences and teach ignorant amateurs the subtleties of applause, but nothing came of it.

The experienced claqueur knows when carefully built-up applause will have the greatest possible effect. Great composers have showed their secret dislike for difficult tenors and arrogant prima donnas by putting a quaver rest at the end of a difficult aria, after which the music continues. Unless the applause starts that very moment there is disaster in the opera house. If you start clapping your hands too early, you spoil the singer's last high tone and carefully calculated effect. If you applaud a second too late, the conductor goes on with the music, and the applause fizzles out ingloriously. The hardest thing is to applaud "into the music" and to literally stop the show, as after "*Nessun dorma*," where Puccini did not feel the need for an ovation. Perhaps he was mad at tenors. Verdi, an old hand at dramatic effects, always left some time for an ovation after a great aria, except when he wasn't sure that there would be an ovation. Perhaps this is why the music goes on quickly after the Nile aria in *Aida*, which is rarely sung well enough to deserve applause anyway.

Schostal would often talk wistfully about the great nineteenth-century claques in Vienna, Paris, and London that had been organized "like embassies" with paid attachés. The claque chefs would attend rehearsals and make notes in their scores, leaving nothing to chance. In Vienna the most famous nineteenth-century claque chef had been Schöntag, whose clients, the singers, treated him almost with reverence. Ernest Marie van Dyck, the great Belgian Wagner tenor, would often be seen driving in the Prater with the imposing Schöntag beside him. Hofoperndirektor Hans Richter played whist with the claque chef. Those were the days. Today there is no educated claque and no claque chef at the Vienna





State Opera, which is now populated by amateurish hand clappers. It's very sad.

SCHONTAG'S successor was a man called Wessely, who owned a house in Hietzing, lived the life of a grand seigneur, and died of a broken heart when Gustav Mahler abolished the claque.

"Then came the terrible, claqueless time," Schostal would recall, thoughtfully drinking up his beer and wiping his mouth. "There was anarchy at the opera. Mahler had to give in. Naturally. They might as well have tried to abolish opera itself."

After the interregnum a man called Freudenberger became claque chef in Vienna. I remember Freudenberger as a tired, old man with a white beard, who would shuffle around the fourth gallery during *Fidelio* and *Don Giovanni*; he was then no longer active. Freudenberger hadn't really loved opera, and during the boring long stretches in the *Ring* and Goldmark's *Königin von Saba* he spent much time in a *Beisl* drinking bad wine. Soon anarchy reigned in the fourth gallery. The singers were unhappy with this state of affairs, and one day Carl Aagard Oestvig, the celebrated tenor, told Schostal, who was then a paying guest and pure-hearted enthusiast at the opera, to arrange for an ovation after "*Salut demeure*" in *Faust*. It came off beautifully.

Schostal, however, ascribed his career to the help of the prima ballerina Marie Jamrich, who had spotted him near the artists' entrance under the Kärntnerstrasse arcades, where he used to hang out when he happened not to be inside the opera house.

"One night Mme. Jamrich refused to undress and appear in the ballet of *Samson et Dalila* unless they brought me to her dressing room," Schostal said. "When I entered, she told me she wanted special applause, 'like these singers.' I promised I would do my best—I would have promised her anything—and

she began to slip out of her petticoats. First a purple taffeta one with ruffles, then a light-purple one made of fine silk with Brussels lace, then a pinkish one of tulle, and at last a beautiful, almost transparent one of white batiste."

At this point in his memories Schostal would wipe his bald head and call for another *Seidel* of beer.

IN the early Twenties when I joined the claque, the great institution had about forty regular members, most of them youthful opera lovers and impecunious students at the Akademie für Musik und darstellende Kunst. Our base of operations was the fourth gallery, where the acoustics were best; Schostal had his command post at the extreme left side, under one of the emergency lights. I had been introduced through a fellow music student and had to pass very strict tests until Schostal was convinced that I had the necessary enthusiasm, knowledge, and timing. Auditions for candidates took place in the backroom of the Peterskeller, where they had a battered upright piano. I almost failed the first practical test when Schostal played the end of the "Flower Aria" from *Carmen* and I wanted to applaud after Don José's "*Carmen, je t'aime*." The experienced claqueur knows that you must wait until the final two *pizzicato* pim-pam of the short postlude. Only then you start, and how! The second practical test was a demonstration of the "correct" hand clapping that produces a dark, somber sound rather than the ugly high-pitched noise made by many clapping females.

A claqueur's operatic ideas are somewhat different from those of the run-of-the-mill operagoer. *Tristan* and *Die Frau ohne Schatten* are easy; no arias, no special cues, no chance for sudden ovations. *Rigoletto*, *Carmen*, and *La Bohème* are very difficult. In the first act of *La Bohème* both Rodolfo and Mimi must get "special" applause after their arias, but when both happen to be clients of the claque great care must be taken that each is getting the same volume of applause. There are, as the English critic H. Sutherland Edwards pointed out over eighty years ago, subtle nuances of applause, from "gentle indications of approval" to "warmer expressions of admiration" to "wild outbursts of (seemingly) uncontrolled enthusiasm."

To applaud well—that is, at the right moment for the right person in the right manner—is far more difficult than you'd think. One had to know the score, one had to understand something of singing, and one had to have a sixth sense for the mood of the audience and meticulous timing. Schostal always knew instinctively whether applause after an aria would go over. If one of our clients was not in good form and Schostal sensed that the mood wasn't right, he would shake his bald head and we knew that the order had been rescinded. The enraged singer would complain bitterly, but Schostal would remain implacable.

On the other hand, Schostal would not hesitate to arrange an ovation for a singer who deserved a tribute even though he hadn't paid Schostal a Schilling. It was this attitude that earned Schostal the



respect of his clientele and the envy of his enemies. Richard Strauss and Bruno Walter often stopped for a friendly chat with him. And Schostal's proudest day came when Operndirektor Schalk invited him to attend some auditions. Schostal had arrived.

We knew that he was the private adviser of the most prominent artists, and not only in questions of applause. Schostal's conferences with Leo Slezak took place in the singer's home, over Bohemian beer and Moravian reminiscences. Alfred Piccaver received the claque chef while he was shaving. Schostal also had private talks with the great divas but he never spoke about them; in his business dealings he was as reticent as a Swiss banker. Once the editor of a Viennese paper offered Schostal the position of music critic but Schostal turned down what he considered an "unethical" offer. In vain the editor pointed out that there had been a claque chef in Barcelona who had doubled as a music critic.

"That can happen in Catalonia but not in the *Kulturstadt* Vienna," said Schostal. "Here the claque has a mission." The missionary was well aware that he had more power than any music critic in Vienna. The claque often made bigger headlines than the artists. After a great claque performance, Julius Korngold, the music critic of the *Neue Freie Presse*, would write: "The claque was again in its usual top form." Malicious rumors said that in return Schostal gave "audible assistance" to young Korngold, the composer of *Die tote Stadt*. They didn't know Schostal: he loved *Die tote Stadt*, with its great parts for Jeritza, Richard Tauber, and Richard Mayr. Schostal even went to hear *Parsifal*, "as a *Privatmann*." There is no applause after *Parsifal*.

Schostal had a secret intelligence network inside the opera house and always had a good estimate of what the evening performance would be like. We would report to him around noon under the arcades where he held court on a park bench. Erik Schmedes, Richard Mayr, and other popular heroes would sit there with Schostal, gossiping and laughing. Schostal would receive the gracious tributes of the singers and get the latest dope on vocal, marital, and other crises. Some of the younger singers gave him a sweet smile, hoping he might arrange for a special ovation after



Frasquita (in *Carmen*), Hellwige (in *Walküre*), or Barbarina (in *Figaro*) sang their few lines. Ha! It took more than a nice smile to get an ovation from the claque.

The size of the claque varied, depending on the opera, the singers, and their contributions to Schostal. On evenings when Verdi or Puccini operas were given, there were twice as many members up in the fourth gallery as during Wagner and Strauss performances. A quarter of an hour before the beginning Schostal would stand near a marble column in the downstairs lobby, handing out tickets and instructions. Each member on duty received his free tickets, and nothing else. Insinuations in the sensational boulevard press that we were paid to applaud were as false and malicious as most of their reports. Many of our detractors were members of the clique, an amateurish outfit operating in the *Stehparterre* under the command of a man named Stieglitz, who was more impressed by the financial contributions of his clients than by their vocal achievements. The squeaking youngsters and shrill girls of the clique operated on the principle that their diva could not do wrong. There are cliques in many opera houses, and they are neither educated nor shrewd, neither cautious nor inspired. "The public [at the Metropolitan Opera House] is much better off in the hands of the claque than in the hands of the clique," wrote my eminent confrere Irving Kolodin. Naturally.



ON the claque's great evenings during the crazy Twenties, when Maria Jeritza sang against Alfred Piccaver, or Leo Slezak against Lotte Lehmann, Schostal would summon the commandos of the claque, called *Hohlposcher*. I remember three of them, Gold, Ritter, and Hofbauer, fearless men who were able to produce a dark, sepulchral sound—Schostal called it "*hohler Klang*"—that had the supreme professional finish. When the *Hohlposcher* started to applaud it was as if a tank regiment were rumbling over a cobblestoned street. On special occasions, when Schostal decided that a floral tribute was due a diva, the *Hohlposcher* would race down the hundred and fifty-two stairs into the parquet, race toward the orchestra pit, and throw across small bunches of flowers which they had hidden under their coats. Such *Continued on page 159*

BY SHIRLEY FLEMING



## GETTYSBURG IN STEREO

**Mercury Records — abetted by infantry, artillery, and cavalry — has invaded the historic battlefield to make a sonic documentary of the War Between the States.**

**T**HE HALF DOZEN deer who had folded themselves peacefully to sleep in the stiff grass just northeast of the Peach Orchard, at Gettysburg, Pennsylvania, woke suddenly in the cold dawn of a gray October day and stared for an instant, before they fled, at the spectacle approaching them along the Emmitsburg Road. Down the valley which had once separated the Army of the Potomac from the Army of Northern Virginia rolled an expedition that, with due allowance for a few anachronisms, might have belonged to the battle scene itself.

At the head of the column some eight or ten men in Union blue were crowded into two station wagons, amid an arsenal of muskets, carbines, percussion revolvers, bayonets, and sabers; through the open tailgate of the leading car protruded two small-rifled ordnance cannons and the brass muzzle of a smooth-bore Napoleon; the second car pulled a trailer on which was mounted a Parrott cannon. Distributed in what little space remained was an assortment of saddles, canteens, and frying pans, in addition to several bags containing enough gun-

powder to blast the whole array sky-high. To the rear—considerably to the rear—of this vanguard, a blunt-nosed truck compactly loaded with recording equipment followed at a cautious speed, and behind it several other automobiles trailed respectfully. Coming to a halt beside the field in which the forces of Longstreet and Sickles had fought each other so bitterly through the afternoon of July 2, 1863, the men in uniform posted the red and white standard of Battery B, Second New Jersey Light Artillery, and began the work of mounting their fieldpieces on cumbersome wheeled gun carriages. Mercury Records, heavily armed, was taking its stand at Gettysburg.

This highly organized invasion of the battlefield in the fall of 1960 marked the culmination of an idea born four years before, on a moonlit night, not far from the spot where Battery B was now unloading. Dr. Frederick Fennell—conductor of the Wind Ensemble of the Eastman School of Music, student of American history, and drummer extraordinary—lay in bed reading, in a Gettysburg hotel

room. His book was the diary of that celebrated commentator on the Civil War, Lt. Col. Arthur James Lyon Fremantle of His Majesty's Coldstream Guards, who joined the Confederacy as an observer early in 1863 and spent some lively months following the course of the war from the Southern side, often seated, when the terrain permitted, in the branches of a well-placed tree. On the afternoon of the second day of the Battle of Gettysburg, while the fighting was raging between Sickles and Longstreet, Colonel Fremantle was to be found viewing the scene from the crest of a ridge opposite, where he had ensconced himself in the fork of an oak just above General Lee's head.

"As soon as the firing began," Fremantle wrote, "General Lee joined Hill just below our tree, and he remained there nearly all the time, looking through his fieldglass. . . . When the cannonade was at its height, a Confederate band of music, between the cemetery and ourselves, began to play polkas and waltzes, which sounded very curious, accompanied by the hissing and bursting of shells."

If the strains of Rebel music had struck Colonel Fremantle as under the circumstances "curious," his report of them struck Dr. Fennell as an irresistible call to arms: he was out of bed and on the battlefield within minutes, wandering about in the moonlight and determining, as closely as possible, where the band must have stood. Almost on the spot he made up his mind to pursue the waltzes and polkas not only of the Confederacy but of the Union as well, to ferret out the music itself wherever it lay buried, and to gather enough original instruments to reproduce the true band sound of the 1860s.

Civil War research which Fennell undertook after this midnight confrontation with history was actually the fruit of a long-standing enthusiasm. As a small boy he had proudly played the part of drummer boy in a family band which gathered yearly to perform on national holidays, and this

early interest in the country's past became a growing historical awareness. The present quest for old music led him through the storerooms of small-town libraries and the files of state historical societies, into military history books and regimental records. Finally, he ran to earth just what he was looking for. In the archives of the Moravian Church at Winston-Salem, carefully copied in a neat and musical hand, reposed the original band books of the 26th North Carolina Infantry Regiment, C.S.A. Their northern counterparts turned up on the more austere shelves of the Library of Congress—a set of twenty-two books which had belonged to the Federal band stationed at Port Royal, South Carolina. To judge from the size and extent of the Library of Congress collection, life at Port Royal (captured by the Union early in the war as part of the concerted effort to cut off Confederate shipping) had proceeded cheerfully enough. Selections ranged from an energetic *Port Royal Galop* to a workable version of the *Freischütz* overture and a number entitled *Un Ballo in Maschera Quickstep*. Confederate music, Dr. Fennell found, ran to homier preferences: *Come, Dearest, the Daylight Is Gone*; *Goober Peas*; *Lulu's Gone*.

The scope of Dr. Fennell's undertaking was already growing when Mercury Records, in the person of Miss Wilma Cozart, caught wind of the project and promptly expanded its dimensions. Miss Cozart decreed that it should become not only a recorded musical documentary but an aural account of the Civil War as well, in which the sounds of the battlefield—the firing of small arms and the reverberation of cannon, the squeak of leather, the neighing of horses, the rattle of mess kits—should all be heard as part of the authentic setting for military music. So, while Dr. Fennell set about the relatively unwarlike task of finding the appropriate old brass instruments, Miss Cozart rallied her forces for the march on Gettysburg.

In one important respect, Mercury Records was



*Miss Cozart directs the firing from Mercury's truck—a control room that houses two three-channel stereo tape recorders as well as two independent monophonic ones.*

uniquely prepared for such an expedition: its entire complement of tape recorders (including two three-channel stereo recorders and two independent monophonic ones) was housed in the custom-designed interior of an aluminum-bodied truck—a control room on wheels which had traversed 100,000 miles of highways through Europe and America on recording assignments. At Gettysburg, power lines along the road would be available for electricity near any point on the firing site, and engineer Robert Fine would have at his command what was probably the most highly mobile unit to be involved with the Civil War since Jeb Stuart's cavalry.

With the truck in readiness, Miss Cozart had next to attend to the gunfire. A call for volunteers was answered by Battery B, a group organized in 1958 to commemorate the original Battery B which had fought under Hooker at Chancellorsville and under Meade at Gettysburg. The modern counterpart was patterned after the original with an accuracy which applied to everything from weapons down to the number of threads per inch in the specially woven uniforms—and not least, to a formidable facility with field artillery. The unit would go into action under the knowing eye of Gerald C. Stowe, curator of the Museum of the United States Military Academy—an expert in armaments who could look upon a battery of cannon with the same regard a hunter feels for a pack of fine hounds.

And so it was that these diversified forces converged upon the Gettysburg battlefield and prepared for action. The cannons were mounted on their carriages and arrayed across the lower end of the

field, and the control truck was parked beside a fence at the upper end, several hundred yards away. Midway between were stationed three microphones on fifteen-foot poles, facing the firing line.

The cannons were loaded with extreme care: an overload of powder in the breech would precipitate the danger of blowing up the entire barrel, and too little would fail to explode with the proper sound effect. The only element missing was live shot itself, usable samples being long since extinct. (And even in this matter authenticity triumphed at a later Mercury session elsewhere: real Minié balls were found for the rifles, and cannister shot, improvised from regular shells and tin cans, was fired in order to record the scattered fragments pelting into the woods.) At Gettysburg, however, wads of wet paper were rammed down the muzzle and packed hard, and the men of Battery B spent much of their day crouched beneath showers of crisp ashes which filtered down after every firing.

Through the morning, the roar of cannonading rolled down the slopes to east and west of the valley, while Miss Cozart, in the cab of the truck, listened to the sound as it was registered by the microphones and directed the firing through conversations by portable telephone with Harold Lawrence, Mercury's music director, stationed near Battery B. Every combination of the four cannons, singly and together, was taped. The Union had its turn and then the Confederacy, and in this detail as in so many others the means were genuine: one of the cannons was, indeed, cast in Mobile, Alabama, in 1861. About midmorning the wind shifted, and the firing had to be reversed so that the sound could continue

*The brass face backwards, and the reeds follow by mirrors. (Fennell is conducting from the rear.)*





*Robert Fine at the microphone records the sound of authentic pistols, fired by authentic-seeming infantry.*

to travel down-wind toward the microphones. Since it seemed easier to move four cannons than three microphones with their involvement of electric cables, Battery B was forced to reëntrench at the opposite end of the recording field.

The taping of small arms proved to be somewhat simpler, although the percussion revolvers went off with such impact that at first they jarred the microphones, held only eighteen inches away, and had to be withdrawn several feet. After the revolvers came the recording of a lone weapon regarded with special fondness by the entire Battery—a Spencer carbine. A specimen of the only rapid-fire repeating rifle used in the Civil War (owned in a limited quantity by the Union but never officially adopted), it could fire seven shots in succession, and the type was referred to by Confederate soldiers as “the gun the Yankees loaded on Sunday and fired all week.” A Battery B man patted its stock affectionately before he shot the first round in front of Mercury’s microphones. “The Union arms supply man was a crotchety idiot, or he would have given these to the whole army,” he sighed regretfully.

Early in the afternoon the cavalry mounts arrived from a nearby livery stable. While two local saddle horses were being persuaded, much against their will, to lend themselves as caisson drawers, the men of Battery B cantered back and forth before the microphones to the shouts of Union cavalry commands. The caisson was finally under enough control to be driven behind them, with considerable banging and clanking. (“When I get through with those tapes, they’ll sound like a whole damned division,” said Robert Fine.)

By sundown the maneuvers were over, and Mercury Records was in possession of several thousand feet of what is undoubtedly some of the most extraordinary tape ever recorded.

The final step remained—to record the music itself, at the Eastman School in Rochester. And this was to pose some problems of its own. Dr.

Fennell had found his Civil War brass instruments in the Rochester Museum of Arts and Sciences and in the Smithsonian Institute, all, of course, unblown for nearly a century and requiring complete overhauling. With the help of students at the School he labored over these for the better part of six weeks, dismantling, cleaning, straightening, adjusting antiquated rotary valves. Furthermore, since the original mouthpieces were of different size and shape from modern ones and to require players to use them would have endangered their embouchures, modern mouthpieces had to be adapted to the old shafts.

On the day of recording came the most delicate problem of all. The horns, used for parade, were made with the bells pointing backwards over the players’ shoulders so that the sound would be directed at the troops, marching in the rear. For the purposes of recording, this would have made no difference except for one detail: the oboes and clarinets still faced determinedly to the front. If the microphones were placed in front for the benefit of the reeds, the sound of the brasses would be lost; if the brass players turned around so that their bells pointed toward the mikes, they would also be turning their backs on the conductor. There was only one solution. Dr. Fennell seated the brass players facing backwards and conducted his band from the rear, while the oboe and clarinet players kept an eye on him through small mirrors attached to their music stands. Since the entire ensemble was lined up on a tiered platform, this put Dr. Fennell in the unique position not only of conducting from the back of an orchestra facing in two different directions, but of conducting downhill.

But the sounds of the Civil War were recorded at last, authentic down to the final note and the last echo of cannon fire. The project had consumed more time and more reels of tape than anyone had anticipated, but Mercury Records had succeeded in producing what will surely be one of the most vivid contributions to mark the Centennial.

BY CHARLES FOWLER



out,



out,

Damned

Knob

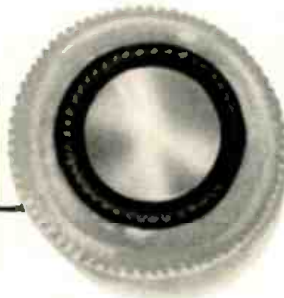

## A flight of fancy by the former publisher of High Fidelity, who in ten years has accumulated forty-four knobs on his scutcheons.

IN SO FAR as high fidelity is concerned, ours is a house divided. One member of the family operates, with frequent and considerable enthusiasm, a mechanism that plays phonograph records. To make it function, a knob must be turned beyond its click point, to get the 110-volt current on, and then as far beyond that as is required to achieve the desired loudness level. The phonograph record itself is placed on a turntable and one of three buttons must be pushed. Moderately careful judgment is required at this stage, to make certain that the correct button is pushed. Otherwise the phonograph might think it had a seven-inch record to cope with rather than a twelve-inch one, or vice versa. The rest of the operation is automatic; the arm positions itself gently and is adequately light. It comes to the end of the record, stops, returns to its rest—all automatically. Sound emerges from a couple of small, simple boxes set in bookshelves across the room. The sound is not in any way dramatic but it is, admittedly, pleasant and well balanced. It could be said to be restful rather than zestful. No serious *aficionado* would classify this system as a high-fidelity rig. It might pass perhaps as a music system.

It is in the domain of the other member of the family that high fidelity comes into its own. Here, in the largest room in the house—and one that has been especially treated acoustically—is a battery of three large speaker systems, driven (the word is well chosen) by several different amplifiers usually working in harmony with one another. Here a symphony orchestra can achieve its full glory. In fact, at times there is a little left over to filter into other rooms of the house.

In addition to the three principal loudspeaker systems, there are four smaller speakers to handle minor chores. There are three tape recorders, two radio tuners, a television set, three preamplifiers, and several pieces of record-playing gear, including two manual tone arms and a couple of things that look like tone arms but are brushes of some sort. Over in a corner is an impressive array of test and measuring equipment, resorted to at regular intervals to make certain that every link in the chain is functioning properly. It is by means of a regular test regimen that distortions can be observed and caught long before they become audible.

At the last count, there were forty-four knobs on the high-fidelity equipment. This is a magnificent total; it can be made almost awe-inspiring if the

twenty-nine switches are added in. It is this type of ultimate planning for optimum flexibility which always separates the men from the boys, true high fidelity from everyday low fidelity.

We are unabashedly proud of our system and feel that a fine and rewarding ambition has been achieved. We grant you, our own objectivity may be suspect because we've devoted so many years to developing this behemoth and to the equally important matter of sharpening our own skill in its manipulation for the realization of its full potential.

There are times, naturally, when things do not go entirely smoothly. There seem to be occasional quite inexplicable non sequiturs. For example, after the third after-dinner highball the system seems particularly likely to operate improperly, simply to hum, or just not do anything at all. Then it is, the next morning, late, that we find the loose wire or, more often, the phase-reverse switch. There is something wrong with that switch. If we don't reverse the phase-reverse switch, when the null-test switch is in the null position and the balance control is completely to the left *and* the stereo function selector is in the A *minus* B position (A plus B is OK), well, then it's just impossible to get any sound from anything.

It was shortly after one of these disappointing evenings that we were sitting in front of the fire contemplating. We didn't have the rig going because we were cultivating a sit-and-ponder mood rather than a stand-and-stride one. (Also, there was a loose wire somewhere.) Not long before, we had been asked to write an article for this commemorative issue of HIGH FIDELITY. We were feeling nostalgic and slightly philosophic, and were trying hard to think of something properly profound to write about.

We hazarded a query to the other half of the family. "My dear, here we sit, thinking of the past and of the future. We have around us the potential for the greatest sonic splendor ever achieved; we are well on the road to the ultimate of high fidelity: stereo. We can re-create music with a degree of exactitude never before known. These things we proudly have; but what of the future? What is there left to achieve?"

There was a moment of silence.

"Well. If you're feeling so philosophic and farsighted, why don't you think about fixing up a system that gives out music without your having to fiddle with so many knobs? Half the time, when you

## KNOB S



want to hear a new record, you have to come in and use my system because something in yours is out of balance or disconnected, or one tube is glowing red while the other is blue. Why don't you see how simple you can make it? Maybe try for no knobs at all."

No knobs? No knobs at all? Nothing to do? How ridiculous can you get! That's always the way. Ask a sensible question, and . . . um. No knobs?

That would mean you would need only a slot of some sort in the front of the cabinet. Take the record out of its jacket and slide it in. That would break a beam of infrared light and start the mechanism. Ah! Since everything would be enclosed, we could have a fan to blow filtered air across the record and out the slot, thus preventing the dust of the house from settling on the record. And there might be some sort of light that would bathe everything with ionized air and remove static from the record, so that any dust already in the grooves would blow off easily. A feeler would sense the size of the record, and the pickup would move down with far more precision and gentleness than could ever be achieved by a shaky human hand.

Now, knobs. No, none yet. Not even a volume control. Leave it off; after all, when you go to a concert, you can't rush up the aisle and tell the conductor to play the music louder or softer. You take what he gives you. And all the "controls" would be put over onto the back of the chassis. That would be the big trick. When the system was first installed, all the adjustments would be made. Since one loudspeaker, because of room design, must be placed nearer a corner than the other, the bass tone control for that channel would be cut back a little. On the other hand, the treble for the other channel would be pulled up to compensate for the draperies near that speaker. And so on—including adjustments for center fill, rumble cut, or anything else.

For further automation, tiny strips of metallic tape on the label could operate controls. For instance, a strip right here, near the edge, would indicate a monophonic record and would automatically trip a relay which would put the two halves of the stereo cartridge into parallel. Another strip, a little nearer the spindle hole, would indicate that this was a monophonic recording of a Swiss goat baying at a crag, and would sound better with only one speaker system operative.\* And so on; the weird future is better told elsewhere. We are trying to be practical.

\* On reading galley proof of this article, we realize we need a third metallic strip. This would turn on the reverberation control, to provide a genuine Alpine echo.

Our knobless concept falters slightly when radio is tackled. There seems to be no reasonable (or unreasonable, for that matter) way of avoiding two knobs, one for FM and one for AM. After the FCC makes up its mind about multiplexing, it might be possible to drop the AM knob. We could still have stereo.

Oh well . . . one knob, just for old-times' sake? Sure! Let's be generous, but otherwise follow the dictum, somewhat modified, of Lady Macbeth: out, damned knob! Out! And then—wouldn't it be marvelous? We could pop a record in and have music. Makes us think of the old bicycle call, "Look, Ma, no hands!"

After smiling tolerantly at this flight of imagination for a while, we began to consider it seriously. Then (and this is the way most logic works) we thought up some good reasons for having embarked on it in the first place.

One reason is that it might make sense to put most of the controls for a high-fidelity system on the back of the chassis rather than on the front panel. As suggested previously, the serious thought here is that high-fidelity equipment should be installed, adjusted, and balanced for a given acoustical environment. An installation should be made by a trained individual, and the more controls and adjustments he has at his disposal, the better. He should adjust and balance for differences in speaker systems, in system components, in room acoustics. Once these adjustments are made, they should be left untouched.

Consider the rumble filter. Why should this be on the front panel? Either the system has rumble or it doesn't. The only time the switch needs to be adjusted is when a new turntable is installed. (If the rumble is in the record, it shouldn't have been bought in the first place.)

This leads to our second reason: should adjustments be made for the characteristics of the recording itself? The days when different record companies used different recording curves—LP, NAB, FFRR—are well gone, and the RIAA is a widely accepted standard. Any sonic differences today are the result of deliberate modifications made presumably at the direction of the conductor or whatever authority is responsible for the end result. Therefore should we not listen with a knobless, unadjustable high-fidelity system so that we judge the over-all result, just as we would if we were to attend a live performance?

We discussed our knobless flight-of-imagination with a well-known record critic. He said he never touched the knobs anyway. A second critic said he liked to get the best he could out of a record and cited as an example the fact that he always had to cut back the bass with records from the XYZ company. Apparently the a & r man, or whoever guides this company's recordings, likes full-bodied bass. But should our friend do this? Shouldn't he write in his reviews, "The bass from XYZ is, to my thinking, too heavy." *Continued on page 161*



# The Barons of Bayreuth



BY PAUL MOOR

In Germany, anybody  
who's anybody must  
be seen in the house  
that Wagner built.

**T**HE WAGNER FESTIVAL in Bayreuth, suspended during the War, was revived in 1951, and I have attended almost all the Festivals since. Germany has in fact been my home for the last decade; and whereas this country's staggering postwar recovery has been a gradual thing as experienced day by day, the visits to Bayreuth at twelvemonth intervals have provided a convenient barometric point to make comparisons from one year to the next. That postwar recovery is customarily referred to here as *das deutsche Wirtschaftswunder*—the German economic miracle. With that miracle has reëmerged an affluent society undreamed of ten years ago. For this society, the Bayreuth Festival offers everything: tickets are expensive, thus eliminating *hoi polloi*; good accommodations are limited, hard to get, and therefore rank importantly as status symbols; the music and texts are rooted in the very dawn of the German soul, distilling the essence of *deutsche Kultur*; and to be seen in Bayreuth, especially at the opening, includes one, at least as far as Germany is concerned, in that tiny group known as everybody who is anybody. Musically the performances are the finest Wagner to be heard anywhere in the world—but for a moment let us digress. . . .

## BAYREUTH



I knew when I first went to Bayreuth that the Allied authorities had said they would not allow the Festivals to resume as long as Winifred Wagner had anything to do with them. As widow of the composer's son Siegfried, Frau Wagner had run things in Bayreuth from 1930 until total war closed the Festival in 1944, and I knew vaguely that the Allies' adamant stand had something to do with her political record. Under this pressure, she turned the direction over to her sons Wieland and Wolfgang, and under their aegis the 1951 Festival presented a magnificent aggregation of talent, topped by Wilhelm Furtwängler. Winifred's two daughters, Friedelind and Verena, were also on hand as co-owners of the family's profitable cottage industry, but without direct voice in the Festival's administration. German friends told me in scandalized tones that Friedelind had forsaken Germany for America early in the war and had published a simply dreadful attack against her own mother. American friends told me that Friedelind had early been a convinced enough opponent of Hitler to do something about it. Most of this went in one ear and out the other; I made my trips to Bayreuth to hear not political gossip but Wagner, and although I had plenty of reservations about what one saw on the Festspielhaus stage, what one heard there was—and continues to be—magnificent. Let it be said here that the Festival's main purpose is to provide the finest Wagner to be heard anywhere, and this it does with love and taste and discrimination, in addition to affording through its Master Classes brilliant opportunity for young singers, designers, and directors to absorb some of the best instruction available anywhere.

Many moneyed Americans of a certain cultivation take the attitude towards music, as one of them once described it to me, of a piano leg: they support it although they don't understand it. God save and protect such individuals (without subsidies from public funds, where would America's musical life be without them?). But whereas in America a certain lamentable diffidence exists about admitting to cultural interests, the opposite is true in Germany, thanks to its ages of cultural tradition; supporting culture is not enough: one must at least *seem* to understand it, and above all regard it as a part of life quite taken for granted. Snobbism takes various

forms around the world, and cultural snobbism is a flourishing variety in Germany, where, modern history notwithstanding, the natives like to call themselves *das Volk der Dichter und Denker*—the nation of poets and thinkers.

The revival of the Bayreuth Festivals was regarded throughout Germany as symbolic of the immortality of German art. Also, especially during the first postwar Festivals, it was a kind of symbol of German indivisibility: a sizable number of soloists, choristers, and musicians were selected from companies in East Germany, and Festival publications carried maps and train and plane schedules which refused to acknowledge even the existence of such a thing as the Iron Curtain. Bayreuth had been a national glory since the Festivals began in 1876, and beginning in 1951 it became a national glory again.

German audiences are not primarily noted for their chic, and this was certainly true during my first visits to Bayreuth. Despite 4 or 5 p.m. starting times on long summer days when daylight died late indeed, dress was *de rigueur*, but most of the clothes had obviously seen better days. Few visitors, of either sex, outshone the refulgent full-dress uniforms of the American, French, and British officers.

The first big change among the German part of the audience came the year Mercedes-Benz brought out its "300" limousine. Suddenly, Bayreuth was full of them at Festival time. Since this princely vehicle was the most expensive automobile postwar Germany had yet produced, its prevalence offered the first clear indication of which strata of German society had taken over Bayreuth as their own. As year by year my travels through Germany extended my own circle of friends and acquaintances, many faces in the audiences took on an ever less impersonal meaning for me. There were, for instance, my friends Karl and Elly Thomass of the old Munich brewing family; I had known them since my early days in Germany as warm, hospitable, cultivated people whom I frequently ran into at musical events and in whose own family circle music played an important and beloved part. But more representative of the new Bayreuth audience was an elderly banker I knew, and knew for a fact to loathe musical affairs of any kind. In amazement, I asked his son during intermission what the old man was doing there. Himself amazed at my amazement, the son replied, "But he *always* comes to the Bayreuth opening." It was difficult to converse with the son; he was more concerned with the people strolling about, and with catching as many as possible of the proper eyes—"Guten Abend, Herr Direktor . . . gnadige Frau . . . Herr Präsident. . . ."

Bemused, I went away (my friend, bent over to kiss a hand, failed to notice) towards the Festival restaurant, across the way, where tea and light meals are served during the long breaks—about forty-five minutes—between acts. Every table seemed full (one

had best reserve in advance, I knew), so I strolled down the aisle between the tables. Some of the faces were familiar to me from the financial pages of the German Press. Gash-cheeked cavaliers, their iron-gray hair closely clipped up to the same level from temple to temple, clinked champagne glasses with matrons whose monocles seemed imbedded in solid granite. A waiter finally found me an empty chair at a table for four, and although the glances accorded me were anything but welcoming, I sat down, joining two gentlemen in opulent dinner jackets and a lady of indeterminable age done up in all the finery new wealth can provide and seemingly dipped in lacquer. One of the men, who was on the point of leaving, presented the other one his card. "And next time you're in Essen, do let me know." The card, on the table beside me, bore the name of one of Germany's industrial dynasties, fragments of whose wares have been removed from a number of Allied bodies during two World Wars.

I picked up the menu, the cover of which was a photomontage of tiny but celebrated faces. They included royalty, government leaders of various countries, and some of the Festival's brightest musical lights. It took me several seconds to realize that one of the faces, unmistakably and without the shadow of a doubt, was that of Franz von Papen, the diplomat who had very early in the game placed his money on the Nazis, helped groom Hitler and bring him to power, flourished under the Third Reich, and been tried at Nuremberg as a major war criminal. Since I was no longer really hungry, I put the menu down and went in search of fresh air, leaving my table companion telling his lady with gusto that the gentleman who had left his card might well turn out to be a very profitable contact.

Outside, I bought a brochure called "Richard Wagner—Life, Work, Festspielhaus," which the imprint identified as having been edited by the Festival Administration. That night after the opera, since sleep was for some reason elusive, I dipped into it. It opened with a curious piece of *belles lettres* by one Zdenko von Kraft, a sort of film-scenario treatment entitled "75 Years of Bayreuth Festival Plays." The account began with May 22, 1872, when Richard Wagner laid the Festspielhaus cornerstone, then ticked off the many great and distinguished visitors (Liszt, Bruckner, Grieg, Tchaikovsky, Saint-Saëns, Mahler, Nietzsche, both Johann and Richard Strauss, d'Albert, Reger, Puccini, Debussy, Hauptmann, Rolland, Shaw, Toscanini) who lent glamour to the Festivals as the administration of them passed from the composer to his widow Cosima and finally, in 1908, to their son Siegfried.

With "The Era Winifred (1930-1944)" the scenario took on a curious change. It is not my purpose to make sport of Zdenko von Kraft's antic English; I quote it verbatim in the interest of objectivity: "It is just so foolish as cowardly attempting to silence from reality facts which have become history. Fairy stories about politics are as incapable

of holding their own as those about the upbringing of children, once things must be elucidated. Winifred Wagner's era coincides closely with the rise, zenith, and breakdown of the third Reich, they almost come to a congruency. An analyzation with regard to the meritorious doctor's degree, and also their supposed original alliance as well as the causal connections must be left to trash-talk of more cunning minds, a simple report can do without it. The main screen-reel of this era is of imposing monotony. But one single camera focus is sufficient: Adolf Hitler's brilliant drive-up with the members of the Reichs Government. . . . While Cosima was under the protection of the expiring century as well as her privileged descent, Winifred is exposed to all hardships of the boisterous time. She maintains herself against them. Her activity, powerful and full of initiative, renounces all standoffishness and ceremonies. Her work is steadfast and preserving. Indeed, Bayreuth somewhat changes its countenance and interpretation, its 'festivity' transforms its course from the inward to the outward. But it remains. lives and has enough power to overcome even misinterpretations. After having withstood all its foes since seven decades, it is well able to oppose the dangerous attacks of its friends and will also in future know how to defend itself against new assaults which might come from heavy cannons in the disguise of politics."

I turned from this double-talk back to the cover. Yes sirree, there it was, all right: edited by the Festival Administration. By this time I had learned, from reading Friedelind Wagner's autobiography *Heritage of Fire*, that her mother Winifred had been an impassioned supporter of Hitler from the very beginning of his political rise, had been among the first few hundred card-holding members of the Nazi Party, had made him a regular honored guest at Bayreuth, and had been so devout that when the vocally anti-Nazi Friedelind refused to return from Switzerland to a Germany already at war, she had told her daughter that even though Friedelind remained abroad, the Nazis would find her and "obliterate and exterminate" her. Winifred Wagner still lives in Haus *Continued on page 155*



*The grandsons, Wieland and Wolfgang Wagner.*

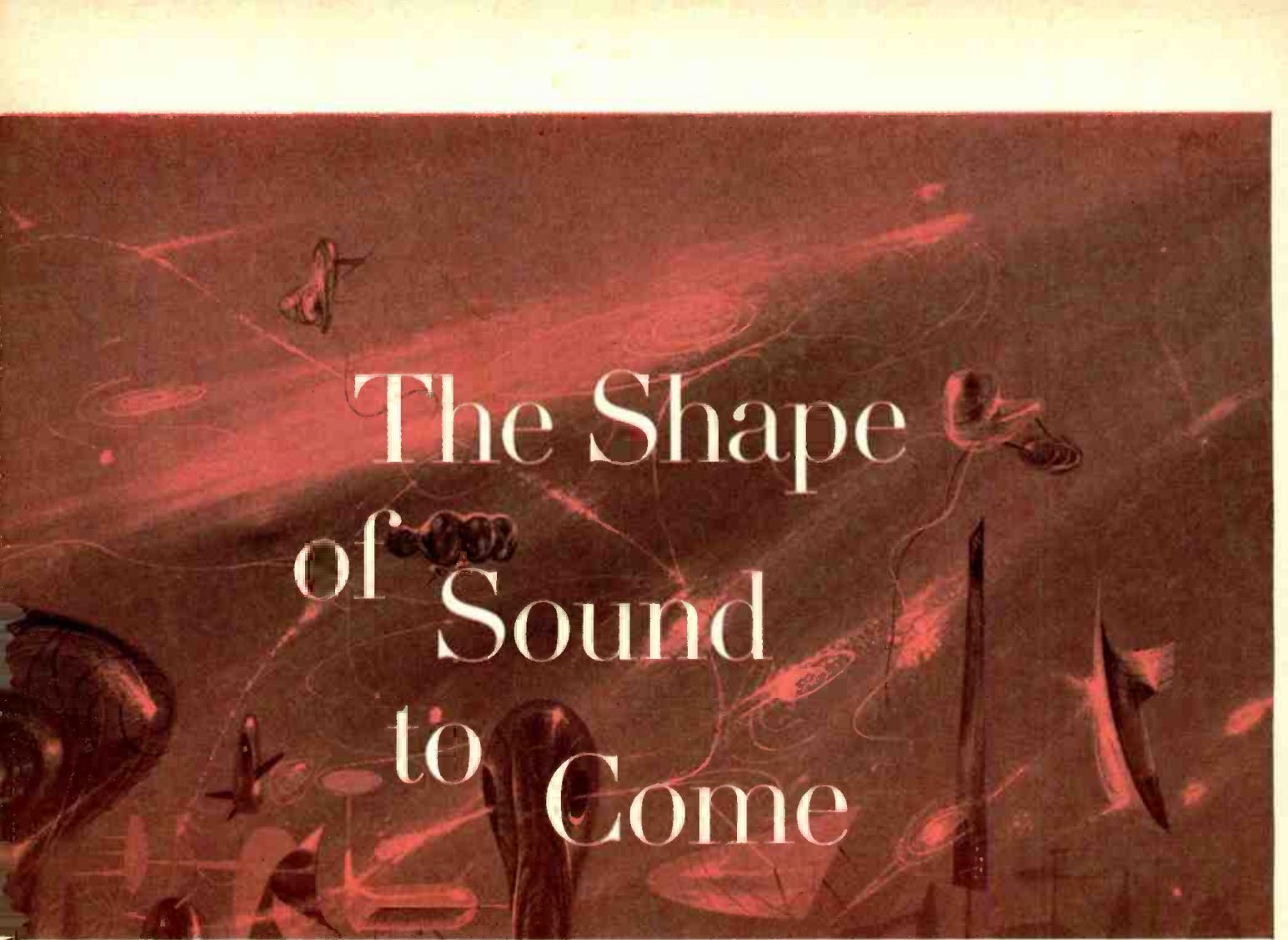

# The Shape of Sound to Come

Drawing by Richard M. Powers

by Robert Silverberg

**A futuristic whimsey which is no fantasy, being  
based firmly on foreseeable fact.**

**J**IM COLLINS hefted the little roll of tape on the palm of his hand, then slipped it into the receiving slot and threw the switch. The satisfying throb of the *Tristan* prelude welled from the speakers. He listened, nodding in pleasure. His sound system was six years old—he'd bought one of the first of the thermoplastic jobs, back in 1978—but it still provided excellent tone, superlative presence and fullness.

He went to the liquor organ and punched out the coordinates for a seven-to-one martini. Thus fortified, he settled down for an evening of some serious listening. It was a fine new performance, with last year's Bayreuth cast. Of course, some of the critics

had said it wasn't the equal of the great old Furtwängler recording of a generation ago, but there were always grumblers. This was a fine performance. Jim had thought so when he heard it on satellite-relayed FM from Bayreuth last summer, and he still thought so.

The prelude flowed into the first act. Jim relaxed, feeling the warm glow induced by good gin and great music. He found himself slipping into a reminiscent mood. How long was it since he'd first heard *Tristan*? The season of '53, wasn't it? He'd been just a kid, then—better than thirty years ago.

*Why, that was way back before stereo*, he realized with a jolt. *I'm just an old fossil! No wonder the*

*kids ask me if we had such things as autos when I was young!*

Before stereo, yes. He could remember his father converting to stereo in—'59, '58, around then. The change had been startling, he recalled. Suddenly you could reach out, practically *touch* the music. Jim chuckled. He remembered his father's pride in that stereo set, with its complex components and controls. It had certainly been a wonderful sound system. He could still slip back across the years and hear the way *Das Rheingold* had sounded, the day Dad brought that great old recording home . . . .

He remembered too his own first ventures in high fidelity—in '64, right after college. Building up, component by component, adding a speaker here, replacing a tuner there, as the budget allowed. Then, the big moment in '72 when the flux-responsive tape machines came along. How awed his wife had looked when he showed her the complete *Boris* on one little roll of tape!

Well, he'd had six good years out of that set, and he'd be using it still, he thought, if it hadn't been for the coming of thermoplastic recordings in the fall of '78. A big step forward in compactness and frequency response. And he'd always been eager to update his system. So . . . .

The doorbell chimed; the roboannunciator delivered its message: "Mr. Fred Gardner here to see Mr. Collins". Jim instructed that his caller be sent up.

He snapped off *Tristan* as his friend entered. Gardner was an electronics engineer, and a college classmate of Jim's. He dropped in, a couple of times a month, to talk about music, old times, and proper martini proportions. Jim hadn't been expecting him tonight, but as usual was glad to see him. "Dial yourself a drink and relax, Fred. I was spending a bachelor evening playing some Wagner."

Gardner dialed his usual three-to-one concoction. "Feel like hearing some Mozart instead?" he asked. "Such as?"

"*Figaro*. Got something to show you. The lab let me borrow one of the prototypes for a day or so." He drew a flat case from his pocket. It looked as though it might house a pair of binoculars, and it did—though they were oddly bulgy binoculars. "This is an advance model," Gardner went on. "We won't be putting them on sale till late fall, maybe not even till the spring of '85. Mind if I borrow your TV screen for the playback?"

"Go ahead," Jim said, mystified.

Gardner uncoiled a jackplug and connected it. He set the binoculars down on a low table, the lenses facing the wall-sized expanse of the Collins video screen, and depressed a button. Sound throbbled from the speakers of Jim's audio system. The sparkling melodies of the overture to the *Marriage of Figaro* danced through the room. An image appeared on the surface of the video screen: the majestic curtains of an opera house.

Now the overture was ending. On the screen, the curtains parted, opening onto a stage view of a half-furnished room. A lovely girl stood before a

mirror, trying on a hat. A man in eighteenth-century costume knelt on the floor, measuring the room, singing out the measurements in a resonant baritone: "*Cinque . . . dieci . . . venti . . .*"

Gardner let the opening duet conclude, then jabbed the button again. The image died away. The room was silent.

The engineer grinned cheerfully. "Nice, isn't it? We recorded it last week at Salzburg, actual performance. This little do-jigger records and plays back also. A photoscopic coder, it's called. I focus through the binocs, use zoom lenses for close-ups, and everything I hear and see is recorded. Kind of a combination home camera, recorder, and projector. Rather good sound, too, you'll admit—though of course this is only a prototype. We'll do a lot better when they're in production." He unclipped a disc the size of a half dollar and held it up. "Here's your record," he said. "*Figaro*, complete. Full frequency response, full color replay."

Jim was silent for a bit. Then, shaking his head. "And I was just thinking tonight about my father's old stereo set. Who'd have dreamed, back then, that in less than thirty years we would be able to have something like *this*?"

"But that old stereo was pretty good, don't forget," Gardner pointed out. "Remember that Richter Brahms Second Concerto . . . ."

"And *Turandot* with Bjoerling . . . ."

"And Bernstein doing the Ives Second . . . ."

"What about Beecham's *Messiah*?"

"Or Von Karajan's *Rosenkavalier* . . . . ?"

Both men burst into laughter.

**T**HE preceding vignette falls into the category of science-fiction. It's set in the future—to be exact, it's set in Mr. Orwell's year of 1984—and it deals with equipment and techniques that don't exist today. It doesn't have to be taken seriously, of course.

Or does it?

Actually, what you've just read is a long way from pure fantasy. High fidelity is continually on the move. Good as present-day home music reproduction is, one can safely say that it will be much improved thirty years hence.

A fact often overlooked in a historical review of the evolution from Edison's hand-cranked little squeaker to present-day stereophonic splendors is that—except for magnetic tape—there haven't really been any break-throughs *in kind* in home music reproduction all during this century. We do things *better*, but not differently. What has happened is a refinement of techniques—substitution of electrical for acoustical recording, perfecting of slow-speed discs, improvements in reproducing equipment, and—most recently—the addition of a second sound channel. Each of these developments has been an important step forward, but up to the present day the basic process has remained unchanged.

That process consists of converting sounds into a pattern of grooves on a solid substance, then using a transducer that will touch those grooves and re-

convert mechanical energy at the pickup point to electrical energy. This amplified and used to drive a loudspeaker that provides a passable imitation of the original sounds. The system has many drawbacks. Noise levels are high, permitting hiss, rumble, scratch, and other extraneous sounds. The use of mechanical parts causes friction that leads to burnouts, breakdowns, and general deterioration. And the complicated nature of the transducers and amplifiers needed makes production costs high.

The postwar development of magnetic tape eliminated some of the friction problems, and thus afforded a leap into new technological levels. But present-day tape recording has *its* drawbacks, too. Sound waves are converted to patterns of magnetic particles which pass before a playback head. The quality of reproduction is limited by noise difficulties: only so much information can be packed into a given area of tape before the playback head becomes unable to decode it accurately. The slower the tape speed, the more closely the information is packed and the greater the decoding difficulties.

There have been advances in the tape recording art, but, as in disc recording, these have been improvements rather than new approaches. Not so long ago, a tape speed of 15 inches per second was considered necessary for reproducing an acceptable frequency range (up to 15,000 cycles or so). By next year, or perhaps even earlier, commercial tape players that claim to provide quality reproduction at only 1 $\frac{7}{8}$  inches per second will be available—a 400% improvement. But the speed can't be slowed much further within present concepts.

New concepts, however, are already making themselves seen. Several parallel lines of investigation are being conducted right now in America's electronic laboratories, and it's likely that these embryonic ideas will be supplanted by even more sensational ones before long.

For example, consider flux-responsive playback heads for tape players. Our present playback heads operate by detecting the *change* in magnetic field as the tape passes by. Flux-responsive heads would be sensitive to the mere *presence* of a magnetic field, whether or not the tape moved. Such a head would simply scan an entire tape on which magnetic patterns had been imprinted, and would convert the patterns to sound without the need for inch-by-inch inspection of the tape. The immediate result would be a tremendous increase in the amount of information that could be crammed on a tape. Today's speeds of 1 $\frac{7}{8}$  ips might give way to speeds of eight or ten inches a *minute*—allowing the complete *Ring* cycle or the hundred-odd Haydn symphonies to be recorded on a single tape, in full frequency range.

Flux-responsive playback heads are not precisely around the corner. They would be solid-state semiconductor devices, for one thing, and their introduction is conditional on the development of new semiconductor materials and assembly techniques we do not yet have. And such slow-speed reproduction would require high-quality instrumentation tape su-

perior to today's products. But it's always risky to underestimate the speed of technological progress. The break-through in flux-responsives could conceivably come within the next decade.

An alternative possibility for music reproduction, scrapping the magnetic angle entirely, is thermoplastic recording—which General Electric is now rapidly perfecting for use in video taping, and eventually for audio use as well. Like magnetic tape, thermoplastic tape needs no chemical processing and can be played back immediately after recording. The system makes use of an electron beam that sweeps over a strip of moving tape, leaving behind a series of negatively charged trails on the surface layer. This surface layer can be melted and re-solidified many times. Below it is a non-melttable layer bearing a positive charge. After the information is inscribed, the tape is heated, melting the top layer. The opposing charges shape the molten material into grooves much like those on a disc, but narrower. The tape then is cooled again, freezing the grooves into place—all this taking place in a fraction of a second. The tape is fed past a scanner that retranslates the groove information into video images, or sounds, or both.

The system is designed for video recording—which means that it's capable of dealing with frequencies way up in the megacycle range. An adaptation to audio recording, with its mere kilocycle demands, should be simple. It will probably be a good many years—perhaps as many as fifteen or twenty—before thermoplastic recorders can be produced for the home market. But when it *does* get here, thermoplastic recording, thanks to its high bandwidth capabilities, should be even more efficient and economical than flux-responsive magnetic recording. The complete works of Mozart on a single tape? Why not?

But looming on the even more distant horizon is a process likely to scuttle both these forms of tape recording: photoscopic storage, the optical recording and playback of information. Optical storage will provide an incredible density of information—enough to give us computing machines the size of today's portable radios, and certainly enough to provide ultracompression of musical signals beyond anything dreamed of in disc or tape recording.

Digital coding is the secret here. Each frequency, each timbre, each tone color can be assigned a code digit representing a voltage. An optical scanner rapidly surveys the sequence of coded digits, and a transducer converts them back into sounds emerging from a loudspeaker. The beauty of the system is that it will be free from all distortion; if the digit can be scanned at all, it will be scanned accurately, on the *go-no go* principle. The technical stumbling block at the moment is the transducing element, whose basic concepts are still far in the technological future. (We already have some phenomenal scanning devices and coding techniques, but the playback operation poses problems.) Once the necessary coders and decoders have been developed, a digital-coded photoscopic system offers

*Continued on page 154*

BY JOHN S. WILSON

Good-Time Music — or Pure Art?

# The Jazz Dilemma



WHEN Miles Davis, the slight, sphinxian jazz trumpeter, returned home from a tour of Europe last fall, he left in his cool wake a covey of music critics jabbering in annoyance at his stage deportment. Davis' long-standing lack of recognition of his audience—his refusal to acknowledge applause, his unwillingness to let his listeners know what he is playing, his habit of playing with his back to his audience and wandering morosely off the stage when other musicians are soloing—hit the form-loving British particularly hard.

Kenneth Allsop of the London *Daily Mail* called him both "a sour . . . surly sorehead" and "a genius" and suggested that "there are certain obligations upon the stage artist. Civility and a concealment of contempt might be a start." The *Daily Express* remarked on his "cold, even chilling personality."

Back in New York, Davis airily dismissed these complaints. "What am I supposed to do?" he asked an interviewer. "Get up there and say, 'And for our next number we will play the ever popular . . .?' If they don't know what it is, what difference does it make? I spend my time up there thinking about making the music good enough.

"Some people," he continued, "think all musicians, if they're Negroes, should be Uncle Toms. They say, 'Why doesn't he speak? Why doesn't he bow?' "Nobody," Davis commented, "does that any more."

One of the many exceptions to this sweeping generalization is Julian "Cannonball" Adderley, an alto saxophonist who spent two years as a sideman in Davis' group and now leads his own quintet. Adderley, a genial, thoughtful, and highly articulate man, not only bows, speaks to his audiences with easygoing wit, and gives the performances of his fellow musicians what appears to be enthusiastic interest, but he thinks it *does* make a difference to have his audiences know what the next number will be.

"I like people to appreciate what I play," he explained, "and sometimes it's necessary to tell them what you're doing so they'll understand. I'm sort of vocal program notes."

The positions taken by Davis and Adderley represent a relatively moderate balance between opposing points of view in an argument that is becoming an increasing irritant in the jazz world: Is the jazz musician an artist or is he an entertainer? At one extreme, the proponents of jazz as "art" would dismiss as "show biz" (and thus beneath contempt) anything offered without high seriousness of purpose; those on the other end of this seesaw will tolerate nothing that is not reduced to the most obvious, stereotyped terms.

"Jazz should be an art for a few people who have the sensitivity and the respect and the affection to give something to it," says John Mehegan, who plays, teaches, and writes about jazz. "When it starts to become just another show business adjunct, and we cater to that, I think we are on the verge of signing our death warrant."

The clearest foreshadowing of this death warrant



## JAZZ DILEMMA

can be seen in television's choice of the great common denominators in jazz—Lionel Hampton jumping through a drum, Louis Armstrong baring his teeth, or almost any girl singer torturing a familiar melody out of all recognition.

The drive to bring about the recognition of jazz as art, with no overtones of entertainment, is largely a postwar development and stems, in the view of some observers, less from an attitude on the part of musicians who play jazz than of nonmusicians who write about it.

In its early days, there was no question about the status of jazz: it was functional and it was fun. It was dance music. It was parade music. It was picnic music. It was good-time music.

Right up through the Swing Era and the beginnings of World War II, jazz continued to be a readily accessible music—not because it went out of its way to provide entertainment but because it was inherently entertaining. The urgency in its rhythms, the poignancy of its blues, the excitement generated by its virtuoso soloists had a strong emotional appeal that made itself felt without overt showmanship. Inevitably, however, some of the sense of the dramatic evident in a musician's playing came out also in other expressions of his personality.

The way in which Louis Armstrong constructed a solo, for instance, was one extension of Armstrong's total personality; a concomitant expression of that same personality was his extroverted stage presence, his instinct for making contact with his audience. Similarly the sense of the dramatic that colored Duke Ellington's music was made explicit in other ways—in the placement of his musicians, for example, with drummer Sonny Greer stationed high above and in back of the rest of the band against a backdrop of gleaming chimes and surrounded by a glittering battery of cymbals. It came out, too, in the tongue-in-cheek elegance of Ellington's stage patter.

A more extreme form was the "hokum" characteristic of many early New Orleans bands—the posturing, the interpolation of grotesque sounds. This was a natural adjunct of the Original Dixieland Jazz Band when it hit New York in 1916 and

set off the jazz fad at Reisenweber's Restaurant. The fact that this byplay has long since been reduced to mechanical "funny hat" routines does not lessen the validity of "hokum" as used in its original setting. Rather, it points up the tastelessness that almost invariably contributes to the dilution of any aspect of jazz that becomes very popular . . . from the later self-caricature indulged in by the Original Dixieland Jazz Band in its efforts to hold its audience through the wanness of the fading swing bands (and, for that matter, of the style-setting swing bands themselves in contrast to those bands from which they drew the essentials of their style) right down to the current adulteration of the blues practiced by the "soul" faddists.

When the "show biz" element became dominant, jazz went out the window (and it still does, as witness the withering away of George Shearing). But "show biz" elements were always present to some degree in the early days, and they don't seem to have interfered with the jazz expression of those who had something to express. The idea that jazz was an art was simply taken for granted by those interested in jazz. Since jazz was the product of creative effort, obviously it was an art. Some jazz musicians were artists of a high order, others of a lesser order. But this was not a matter of great concern.

Possibly the first pretentious attempt to make an issue of jazz as art was Stan Kenton's reference to his music as "Artistry in Rhythm," a promotional line that led to a humorless journey through nonjazz and the development of a set of distinctly show-biz-based mannerisms, one vestige of which still remains today in the sweaty stance of crucifixion with which Kenton chooses to underline the climaxes of his foundry brigade.

But even before the arrival of the overt insistence that jazz is art, the anti-entertainment attitude had begun to take shape. During the War the fledgling boppers developed an in-group branch of jazz which, whether deliberately or not, shut the door on older forms of jazz. Earlier jazz was dismissed as though it had never existed. Along with it, everything that had been associated with jazz was rejected—jazz as dance music, jazz as entertainment. The emotional qualities of jazz were denigrated in favor of the intellectual qualities. Jazz became a listening music in which a celebrating audience contemplated a group of stone-faced, seemingly bored musicians, some of whom, thanks to the introduction of the long, long solo, could think of nothing to do for extended stretches of time but look forlornly off into space while waiting their own turn.

Miles Davis' solution to this problem—walking off the platform—is, according to Cannonball Adderley, the best one, although Adderley him-





self stays on, snapping his fingers and wagging his head appreciatively at each soloist. Adderley, in fact, is practically unique among postwar jazz musicians in his readiness to appear to be enjoying himself (Dizzy Gillespie and Gerry Mulligan also have this happy faculty). So entrenched has the tradition of the sullen jazz musician become that, Adderley says, "It's no longer possible to play jazz and smile."

"When you smile," he explained, "people think you're insincere. You're accused of being commercial or putting on a show."

The identification of commercialism with even so slight a gesture towards the idea of entertainment as a smile may well stem from the unfortunate circumstance that when jazz was entering its wooden-faced stage the alternatives of jazz-as-entertainment were discouraging even to those who felt the need for leavening. On one hand, there were the Jazz at the Philharmonic concerts which, while they gave employment to many worthy jazz musicians, required these musicians to put on exhibitionistic displays that were neither good jazz nor good entertainment (although they found favor with young audiences in search of a good synthetic frenzy in those pre-rock 'n' roll days). On the other hand, there was that veteran of a more amiable period of jazz, Louis Armstrong, whose every grimace, every eye-roll, every blinding show of teeth had become frozen to an exaggerated formula. To many young Negroes, Armstrong seemed to represent the white stereotype of the Negro-as-entertainer—the grinning, happy-go-lucky, subservient clown. Their reaction stimulated such extreme views of the role of the jazz musician as entertainer as Miles Davis' feeling that to acknowledge applause by bowing is to provide evidence of an Uncle Tom attitude.

The anti-entertainment view of jazz is primarily predicated on a desire to uphold the dignity of the Negro. The pro-art attitude, however, is more concerned with attaching greater dignity to the music itself. The first point of view does not necessarily support the second. Davis, for all his aloof bearing, has gone on record as saying, "I don't go with this bringing 'dignity' to jazz."

The jazz-as-pure-art approach got a helpful boost when dance floors were eliminated from jazz clubs and the jazz audience became almost entirely a listening audience. This gave the jazz musician the focus of attention worthy of an artist, with nothing to distract from it except for drinkers, waiters, and conversationalists. With the spread of jazz to the concert hall even these annoyances were eliminated and art appeared to have a clear field. Since the concert hall has turned out to be more stultifying than helpful to many jazz musicians, however (and jazz concerts have, in most cases, proved to be discouragingly unartistic affairs), even some of those who once saw the concert hall as the salvation of

jazz are now conceding that small night clubs, for all their drawbacks, may actually be a more fruitful environment.

But meanwhile art and dignity were getting a boost from another direction. The steady influx of conservatory-trained musicians and composers to the jazz area in the postwar years brought to jazz some largely superficial connections with European music and reinvigorated an idea that had dogged the fringes of jazz for years: that if jazz were more like European music, it might be worthier of attention. Previously, European influences had been imposed on jazz by outsiders, people not otherwise associated with jazz. Now the influences were injected from within and had considerably more substance, coming as they did through jazz incubators ranging from Stan Kenton's band to the Modern Jazz Quartet.

Most of this European cross-breeding was so starchy that it withered, dried, and disappeared, although a small but growing trickle seems to be finding a valid place as what Gunther Schuller calls "third stream music"—a music built on both jazz and classical devices but actually falling into neither category. Part of the classical coating found a response among the culture climbers who discovered that Dave Brubeck was an exciting jazz musician because he had studied with Darius Milhaud and casually tossed classical quotes around his solos.

Their opposite numbers of the classical world felt that there must be something superior about the Modern Jazz Quartet because European audiences in the very heartland of classical music sat through its concerts with the same quiet respect they might give the Budapest Quartet.

Neither attitude was much of a compliment to jazz, since these performances were being admired for things that had nothing to do with jazz. By itself, this sort of condescension could not have spawned the "jazz is pure art" school.

But it did help to create an atmosphere into which a pride of jazz's literary lions have moved, to declare unequivocally that jazz must be undefiled by any taint whatsoever of "show biz," commercialism, or entertainment.

This point of view is largely centered in this country among writers who appear in *The Jazz Review*, a somewhat monthly magazine edited by Nat Hentoff and Martin Williams. Six years ago Hentoff was bewailing what he called the "mass goofing of the intellectuals" because of their "frequent preference . . . for early blues, New Orleans, later Dixieland, and 'revivalist' jazz" rather than postwar jazz. Since then Hentoff has become steadily more waspish as he has moved farther and farther out on two very opposite limbs of the jazz tree—the folk origins of jazz and the intellectuality of jazz. Williams is one of the more sweeping castigators of "show biz" influences in jazz, although he has long been an avid supporter

*Continued on page 156*





# Great Recordings

## OF THE DECADE

WHEN one has a chance to pull up briefly at a landmark—like a tenth anniversary—the tendency is to treat it as a resting place, and to look back a moment at the distance just traversed. This is exactly what we did on several hard winter evenings not too long ago, chiefly to remind ourselves of how we had reacted, at the time, to some of the decade's notable events.

"Notable events" to us means—among other things—significant record releases, and we trust that our feeling of genuine wonderment at the things we have seen (or heard) is less a sign of old age than a proof of the barely credible bounty of our first ten years. For the maturation of microgroove discs and the nascence of stereo have brought both a quantity and a quality of recorded sound hitherto quite inconceivable.

Our first tentative trip through back issues turned up no fewer than seventy-five titles, all of which might well deserve inclusion in any list of "great" recordings. All of them met the highest standards of performance and recording, and none would be out of place in any record library. But it seemed to us that classification of a recording as "great" depended on attributes beyond that of undeniable excellence. There are a few recordings which transcend the usual criteria of judgment—which are beyond mere perfection. One thinks of Erich Kleiber's *Der Rosenkavalier* and *Le Nozze di Figaro*; no one would contend that these are unflawed performances (though they are not far from that), but the nature of the achievement is such that flaws simply do not matter.

One of the phonograph record's essential functions is that of a document, and many of the recordings on this list have a distinct documentary value.

Some preserve a great artist of the era at the peak of his powers, performing music for which he has special affinity. This is assuredly the case with Rubinstein's Chopin, Landowska's Bach and Mozart, Gieseking's Debussy, or Flagstad's *Isolde*. Others perpetuate in a characteristic fashion significant movements or tendencies of the decade, and some have been selected primarily for their representative qualities. It was obvious, for example, that one of the Brecht/Weill/Lenya albums should be chosen; the revival of this team's German operas and ballets has doubtless been one of the decade's important artistic phenomena, and the phonograph has played no small part in it. On the basis of performance level, we might easily have chosen *Mahagonny*, or Lenya's album of German theatre songs; *Die Dreigroschenoper* seemed to us quintessential.

Not all these recordings will survive changing times—not all the treasures of the Twenties and Thirties are with us today, for a commercial company must make most of its decisions on a sound commercial basis. If the entire output of Carl Orff seems *vieux jeu* two decades hence, it is not likely that the splendid presentation of his *Der Mond* will be re-released *ad infinitum* as a service to the Muse. That does not alter the nature of the achievement. We have a feeling that most of these recordings will be with us for a lifetime, regardless of technical metamorphosis to come.

Here they are. They do not represent a basic library for the collector, or a balanced selection of romantic, classical, and baroque, or an inclusive survey of the favorite performers of our time. They are simply among the best recordings of the past decade that we ourselves cherish. There are forty of them.

**BACH: Goldberg Variations.** Glenn Gould, piano. Columbia ML 5060. Reviewed in February 1956, by Nathan Broder.

"A remarkable performance by a young Canadian pianist whose name and deeds were hitherto unknown to this reviewer," said Mr. B. in his first hard look at Mr. G. "Gould realizes that this is harpsichord music *par excellence* . . . he does not superimpose any pianistic 'effects' within the course of a variation . . . everything is beautifully phrased and even the most contrapuntal sections are cleanly and clearly articulated." In conclusion, "this is an extraordinary performance that leaves one eager to hear what else this very gifted player can do."

**BACH: Organ Works.** Helmut Walcha, organ. Archive ARC 3013/30. (Eighteen records, available separately.) Reviewed in February 1956, by Nathan Broder.

"Here is a treasury of the greatest music ever written for the organ . . . practically all of Bach's important organ works may be found here," jubilated N.B. "Walcha has long been admired as a performer of Bach . . . his playing is sensitive and intelligent, his registrations varied and tasteful, his technique big enough to encompass the manifold problems of this music with apparent ease. . . . It is difficult to single out any of these discs for special recommendation. It seems pretty safe to say that no matter which one you may start with . . . you are not likely to remain satisfied with only that one."

Certain of these works have since been re-recorded by Helmut Walcha and released in stereo, but it is this virtually complete anthology, symbolic of the thoroughness and thoughtfulness which has characterized the Archive Series, which stands as a unique achievement.

**BACH: St. Matthew Passion.** Laszlo, Rössl-Majdan, Munteanu, Cuenod, Waechter, Standen, Rehffuss, *et al.*; Chorus and Symphony Orchestra, Hermann Scherchen, cond. Westminster 4402 (originally released as WAL 401). Reviewed in January/February 1954, by David Randolph.

A desire for objective description of competing versions ("the ultimate choice in something as tremendous and variegated as this work," he explained, "must be left to the listener") led Mr. Randolph to eschew value judgment in his review. He did observe, however, that Scherchen makes the work "an intimate experience," and that, "thanks to the recording, the parts emerge very clearly etched, and in the greatest detail . . . [he] obtains a marvelous clarity of line and texture."

Nathan Broder, our present expert on Johann Sebastian, had occasion to say this in his September 1955 discography: "This is a performance that results from profound insight and enkindling imagination. Each scene of the drama is given its full value, and so is the pathos of the commemorative and deliberative portions . . . Cuenod's is a first-class Evangelist, and Rehffuss sings the role of Jesus with sublime sweetness."

As with the same conductor's *Messiah* (see below), the appearance (among other versions) of a stereo re-recording has failed to unseat this performance in the affections of many devotees.

**BACH: Well-Tempered Clavier.** Wanda Landowska, harpsichord. RCA Victor LM 1017, 1107, 1136, 1152, 1708, 1820. Released over a period of time and reviewed by various critics.

The final results of this project were made available in the fall of 1954, when the sixth and final record of Preludes and Fugues was released. At that time, Roger Pryor Dodge commented on Mme. Landowska's keen perception of the dance rhythms on which these pieces are based. Further: "Wanda Landowska deserves sole credit for her vital alerting of our age to the values of the harpsichord in the interpretation of Bach. . . . [She] has a miraculous gift for endowing a notated page of music with the measured feeling of dance. And this with no sacrifice of her over-all artistry in subtle phrasing and just dynamics. . . . The 'authenticists' err in believing that the key to quality in interpretative style can be found in following detailed material from critical books of the past. Landowska, familiar with the same books, imparts a rhythmic playing style not derived from them. . . . All in all, Bach's forty-eight preludes and fugues for the *Well-Tempered Clavier* may never have sounded so good since the eighteenth century."

In 1957, our Bach discographer, Nathan Broder, observed: "Landowska has here set up a standard that for penetration and for all-round satisfactoriness will be hard to surpass."

**BEETHOVEN: Symphony No. 9, in D minor, Op. 125.** Schwarzkopf, Höngen, Hopf, Edelmann; Chorus and Orchestra of the Bayreuth Festival, 1951, Wilhelm Furtwängler, cond. Electrola 90115/16 (originally released in this country as RCA Victor LM 6043). Reviewed in November 1956, by C. G. Burke.

To Mr. Burke, this recording's "amazing intensity of personal expression must unquestionably have

been influenced by its environment and the memories attending that environment . . . Furtwängler conducted the Ninth in ceremonial rededication of the Wagner theatre when the [Bayreuth] Festivals were resumed in 1951 . . . he used the Ninth Symphony to cleanse the premises [and] enlisted the cosmic evangelist—but a German—Beethoven, in a service of purification. . . . With what skill and patience can be imagined, Furtwängler has transformed the fierce conflict of the first movement into a confession and an appeal . . . the scowl is removed from the Scherzo in favor of a more equable pleasure . . . the slow movement is a long, long, long benediction. . . . Musically not easy to defend, emotionally hard to resist, the Furtwängler projection . . . lays an obligation upon everyone to hear it."

**BEETHOVEN: Symphonies (complete).** NBC Symphony Orchestra. Arturo Toscanini, cond. RCA Victor LM 6901. Reviewed in June 1956, by C. G. Burke.

Mr. Burke traces the recorded history of these interpretations; for some of them, this represents the third edition, for the others, the second. One previous edition of some of the symphonies had been "enhanced" by artificial reverberation—a procedure some critics (including the Maestro himself) had found distasteful. Mr. Burke reported: "In their newest embodiment there is evident no electronic trickery."

There has never been any quarrel with the status of these interpretations, whether one cares for Toscanini's approach to specific symphonies or not. Mr. Burke was especially fond of the conductor's Third (a "vital and noble performance . . . the *Eroica* by which all others must be measured"); the Seventh ("glorious playing of this transfiguration of rhythm"); and the Ninth ("a revelation of the formal and emotional aspects of this stupendous homily").

In concluding: "A few words . . . in praise of the orchestral quality—the homogeneity of stroke . . . the even lines, the exactitude of intervals, the unparalleled virtues of the vertical structure . . . ought to be considered not as a matter of course, but as a matter for marvel."

**BELLINI: I Puritani.** Callas, Di Stefano, Panerai, Rossi-Lemeni, *et al.*; Chorus and Orchestra of Teatro alla Scala (Milan). Tullio Serafin, cond. Angel 3502 C. Reviewed in January/February 1954, by James Hinton, Jr.

Observing that *I Puritani* is relatively unfamiliar because "it is too difficult to cast," Mr. Hinton pointed out that the availability of a young soprano, one Maria Callas, is re-

sponsible for a spate of Rossini and Bellini (but not yet Donizetti) revivals in Italy. "Maybe, some day," he speculated, "I will be able to write about Miss Callas without uttering exclamations of wonder, but not yet." (By January 1956, he opined that her Aida has "ups and downs of communicativeness" and is subject to "vocal misses and near misses"—*sic transit*.) In *I Puritani*, "she combines such a fine dramatic gift with such a beautiful voice that she is impressive even when not exhibiting her really fabulous coloratura technique . . . Di Stefano gets through the stratospheric tessitura without losing beauty of tone," while Panerai and Rossi-Lemeni bring "voices that are good" to singing that is "honest and dramatically right. . . . The performance as a whole is permeated by the aristocratic intelligence of Mr. Serafin's supple, alert conducting."

*I Puritani* was the first of Angel's Callas revivals of pre-Verdi Italian opera, and to many it remains the best.

**BERG: Wozzeck.** Farrell, Harrell, Jagel, *et al.*; New York Philharmonic, Dimitri Mitropoulos, cond. Columbia SL 118. Reviewed Spring 1952, by Alfred Frankenstein.

Writing at a time when *Wozzeck*, though already twenty-six years old, was an almost entirely unknown quantity to American music lovers, Mr. Frankenstein concluded a lengthy analytical description of the opera by saying, "Hearing the work on records . . . one is not only filled with the idea of the opera, but is seized and shaken by it in a feverish and overwhelming experience . . . *Wozzeck* is a truly great tragedy, a work of intense expressiveness and subtle pathos as well as a stark, sinister drama." Of Columbia's version, still the only one in the catalogue: "The recording, taken from the Philharmonic broadcast of April 15, 1950, is superb, and so is the performance . . . it is done with complete conviction, clarity, and apparent ease by all concerned."

**BERLIOZ: Grande Messe des Morts, Op. 5 ("Requiem").** Simoneau; New England Conservatory Chorus; Boston Symphony, Charles Munch, cond. RCA Victor LDS 6077. Reviewed in May 1960, by Joseph Roddy.

Half of Symphony Hall's ground-floor seats were removed to make room for the BSO, and the gigantic forces called for by the composer were deployed in parquet, on stage, and through the balconies. The result: "RCA Victor has acquired a magnificent recording. . . . Beyond the Boston orchestra, which has the habit of perfection, the special

splendor here is the chorus . . . the entire singing force seems to share one vibrant intelligence . . . the a cappella "*Quaerens me*" has some of the loveliest and most limpid choral passage work ever recorded. . . . The recording is, of course, as stereophonic as it can get." As for all competition, this set "drives it into limbo."

The Berlioz performances of Munch and the Boston Symphony have been among the musical glories of the decade, and here the most massive of the composer's works is given a recording that does it full justice.

**BIZET: Carmen.** De los Angeles, Micheau, Gedda, Blanc, *et al.*; Chorus and Orchestra of Radio-diffusion Française, Sir Thomas Beecham, cond. Capitol GCR 7207; SGCR 7207. Reviewed in February 1960, by Conrad L. Osborne.

Because of intracast disagreements, this was one of the most difficult of all recording projects to complete, but it proved worth waiting for. For C.L.O., Sir Thomas' statement is "close to definitive . . . [it] calls back to the listener all the excitement and terror of a second or third hearing of the opera . . . the feelings we know *Carmen* ought to arouse, but which seasons of mediocre playings have buried." Victoria de los Angeles' *Carmen*. "quite unlike the wild-behaving, chesty-sounding toughie we generally encounter," is instead "calculating, insinuating . . . and the evenness and focus of her voice are certainly welcome . . . Gedda sings cleanly and resonantly . . . Blanc has a sonorous, wide-open baritone . . . no opera lover should be without Sir Thomas' magnificent exposition of the score."

**CHOPIN: 51 Mazurkas; Polonaise-Fantaisie in A flat, Op. 61; Andante Spianata and Grande Polonaise, Op. 22.** Artur Rubinstein, piano. RCA Victor LM 6109. Reviewed in January/February 1954, by Ray Ericson.

Greeting this remake of a set that had long been a glory of the 78 catalogue, Mr. Ericson said contentedly: "A few sample comparisons indicate no great change in Mr. Rubinstein's interpretations over the years. The fire, aristocracy, and passion are still there . . . it is even possible to enjoy all two hours of them in one sitting." And, in summary: "Other pianists will go on recording the mazurkas, but this album will provide the measuring rod by which to judge the success of their efforts."

Indeed, it still does, though the continued activity of Mr. Rubinstein, in both the concert hall and recording studio, make it not incon-

ceivable that we shall yet have a third edition from one of the century's authentic masters.

**DEBUSSY: Piano Works.** Walter Gieseking, piano. Angel 35026, 35066, 35067, 35065, 35488, 35250, 35249. Released over a period of time, reviewed by various critics.

In greeting the first releases in this series (September 1954), Ray Ericson said, ". . . Debussy's solo piano works find [Gieseking] at the height of his powers, which means that these particular records are incomparable. . . . The interpretations differ little from those on the memorable Columbia issues. . . . Where differences occur, the subtleties have become subtler, the jeweled tones more iridescent, the attacks defter, the rhythmic and dynamic effects as precise but more muted."

Roland Gelatt had this to say about later releases (November 1955): "Nobody else today coaxes such misty tones from the piano . . . Gieseking's penumbral mastery goes unchallenged. . . . Just to hear the way he shapes and colors the opening melody of *Canope* is reason enough for acquiring the record."

Here is the entire keyboard side of Debussy, as rendered by the late pianist regarded by nearly everyone as the great impressionist's foremost interpreter.

**FALLA: El sombrero de tres picos (complete).** Suzanne Danco; Orchestre de la Suisse Romande, Ernest Ansermet, cond. London CM 9055 (originally released as LL 598). Reviewed in January/February 1953, by C. G. Burke. "Mr. Ansermet is the right man," said Mr. Burke. "His variety of nuance and pace are astonishing and he is always at his best with the Geneva orchestra . . . the disc is destined for longevity."

In this last, C. G. B. was clearly correct, since the performance still holds its own against all comers. About midway in its career (July 1957), Robert C. Marsh added this comment in his Falla discography: "Ernest Ansermet conducted the first performance. To say that he knows the tradition is misleading: he created it. His recording of the entire score is therefore a definitive edition."

**HANDEL: Messiah.** Ritchie, Shacklock, Herbert, Standen; London Philharmonic Choir and London Symphony Orchestra, Hermann Scherchen, cond. Westminster WAL 308. Reviewed in May 1954, by C. G. Burke.

With scholarship having restored for this recording the conditions prevalent at the first performance in 1742,

this *Messiah* was "unlike any on records or any to be heard in public performance. . . . Dr. Scherchen has lavished on this wonderful *Messiah* talents of illuminated leadership quite independent of questions of archaicism or correctness." The chorus performs with "fury, awe, abnegation, and pity . . . too telling, too personal, to have been extorted only by discipline. The soloists, not one with a voice of great quality, contribute some great singing of their words, by force of understanding and convictions." A properly small orchestra plays with a "fanaticism of inspired energy." The set's novelty is "an antiquity of 212 years, but nevertheless breath-taking."

Between '54 and '61 there have appeared several new performances of the score (including a stereo remake by Dr. Scherchen), all adjudged inferior by our Handeli-ans-in-residence.

**HANDEL: Semele.** Jennifer Vyvyan, Anna Pollack, William Herbert, *et al.*; St. Anthony Singers; New Symphony Orchestra of London, Anthony Lewis, cond. Oiseau-Lyre 50098/100 (deleted). Reviewed in May 1956, by C. G. Burke.

In an essay dealing with recordings of both *Sosarme* and *Semele*, Mr. Burke opined that while "the power of music is in *Sosarme*, a greater power of gentler music" is in *Semele*, "graced by an airy pliancy of its verses and a tongue-in-cheek contemplation of the tragedy by the poet. Imperial Handel found such worldliness to his liking and made the most of it. *Semele* is crowded with felicities." Of the performances: "Competent singing well stylized without importunity, a direction in general spirited, and a union of effort in a lofty cause."

Recalling that Handel assigned much music to *castrati*, C.G.B. averred that "the most ambitious of today's impresarios must admit that a revival of castrization as an aid to art and faith does not seem imminently feasible." No more imminent now, perhaps; but performances of Handel operas are increasingly frequent, and to Oiseau-Lyre must go a share of credit.

**HAYDN: "Salomon" Symphonies, Nos. 93-104.** Royal Philharmonic Orchestra, Sir Thomas Beecham, cond. First series (Nos. 93-98), Capitol GCR 7127. Second series (Nos. 99-104), GCR 7198; SGCR 7198. Reviewed in December 1958 (first series) and May 1960 (second series), by Robert C. Marsh.

Never have Haydn's jokes been better told, his surprises more adroitly

prepared, or his themes stated in tempos more unassailably right," wrote R.C.M. when the first of the *Salomons* appeared. The second volume evoked equal enthusiasm. In total, the twelve last symphonies of the most prolific of the great symphonists are here "given to us as the precisely polished efforts of the man who . . . created the standard by which all Haydn performances must be judged. . . . Together they offer performances of such unflinching communicative impact as to rank among the enduring triumphs on discs."

**IVES: Symphony No. 2.** New York Philharmonic, Leonard Bernstein, cond. Columbia KL 5489; KS 6155. Reviewed in November 1960, by Alfred Frankenstein.

After a bow to F. Charles Adler, conductor of the old SPA recording which was for some years the only available version of this work, Mr. Frankenstein notes that it is "now rendered obsolete. . . . This is the first American symphony to set beside Schumann and Brahms, and it is still one of the noblest, most beautiful, and most entertaining. . . . Bernstein's interpretation possesses that charm and blandishment which are uniquely his. . . . the recording is absolutely superb, in both mono and stereo."

**MAHLER: Das Lied von der Erde.** Ferrier, Patzak; Vienna Philharmonic. Bruno Walter, cond. London A 4212 (originally released as LI. 625-6). Reviewed in March/April 1953, by Paul Affelder.

"At long last," wrote Mr. Affelder, "we have the definitive recording of this work by the composer's friend and disciple, Bruno Walter, who gave it its first performance in 1911. He is aided by two superb soloists. . . . rich-, deep-voiced Kathleen Ferrier, and Julius Patzak, a Viennese veteran tenor, [who] still has freshness in his voice and sensitivity in his performance."

"Songs of the Earth" have come and gone (there are seven in the catalogue now), but this one, coupled with the late Ferrier's interpretations of the Rückert songs, continues to hold the affections of most Mahlerites.

**MOZART: Concertos for Horn and Orchestra.** Dennis Brain, horn; Philharmonic Orchestra, Herbert von Karajan, cond. Angel 35092. Reviewed in December 1954, by C. G. Burke.

In a happily metaphoric mood, Mr. Burke began his brief but enthusiastic review: "Here a record of surpassing art blows its predecessors to the four winds. . . . Mr. Brain skips over the bland hurdles and around the delectable pitfalls contrived by

Mozart with a shining assurance. . . . Von Karajan maneuvers his skillful orchestra with ebullience and grace. . . . Angel captures the sound with a felicity uncommon for the King of wind instruments."

In discussing perfection, there was little more to say. . . .

**MOZART: Le Nozze di Figaro.** Della Casa, Gueden, Danco, Siepi, Poell; Chorus of the Vienna State Opera; Vienna Philharmonic Orchestra, Erich Kleiber, cond. London A 4407; OSA 1402 (originally released as XLLA 35). Reviewed in November 1955, by James Hinton, Jr.

Mr. Hinton observed that this recording has "a kind of total artistic quality rarely heard either in actual performances or on records. . . . Considering it very seriously, this is certainly one of the finest of all operatic recordings so far as the musical whole is concerned." As to individual singers, he found Lisa della Casa giving a "very lovely, gracious performance"; Hilde Gueden singing with "point and personality"; Suzanne Danco giving us a Cherubino that is "splendid—ever so style-wise and responsive." The men came in for almost equal praise. He concluded that the set had "no present competition"; and while several editions of *Nozze* have been released over the past five and a half years, none has quite met the Kleiber standard. The stereo edition was received with enthusiasm in December 1958, by David Johnson: "This is the *Figaro* I would get if I weren't lucky enough to have it already."

**MOZART: Sinfonia concertante for Violin, Viola, and Orchestra, in E flat, K. 364.** Isaac Stern, violin; William Primrose, viola; Perpignan Festival Orchestra, Pablo Casals, cond. Columbia ML 4564. Reviewed in July/August 1953, by C. G. Burke.

Pablo Casals came out of self-imposed retirement in 1950, and our first decade saw him well represented on records, both as solo cellist and as conductor. This recording, on which he appears as conductor, persuasively demonstrates his luminous artistry. Considering several versions of the *Sinfonia concertante* in his exhaustive Mozart discography, Mr. Burke had praise for several editions. But "all are insufficient when the Columbia has been heard. . . . With Messrs. Stern and Primrose in form, the extraordinary Casals touched with enlightenment, and an orchestra of superb poetic responsiveness, [this recording] is one of the sparse marvels in the Mozart discography. . . . The many tiny mutations of tempo and stress which give this perform-

ance its distinction are stated with a unanimity implying implacable direction, yet the phrasing is fluid, the lyricism tender. . . . The sound has been beautifully engineered into a mellow and seductive orchestra likeness, without any straining for effect. . . . A compulsive triumph."

**MOZART: Sonatas for Piano: in B flat, K. 333; in D, K. 311; in E flat, K. 282; in G, K. 283; Rondo, in A minor, K. 511: Contretanze, K. 606 (arr. Landowska).** Wanda Landowska, piano. RCA Victor LM 6044. Reviewed in January 1957, by Nathan Broder.

This slightly belated addition to the Mozart Bicentennial celebration releases turned out to be, in Mr. Broder's opinion, one of the most important. "A group of performances," he declared, "that may very well serve henceforth as a model of Mozart interpretation . . . Mme. Landowska knows that the pianos of Mozart's time were so constructed that there was a sharp difference in tone colors among the high, middle, and low registers . . . by delicate adjustments of arm and finger weight, she miraculously manages to achieve such differentiations of color on a modern piano." Most of her many added embellishments and ornaments are "plausible and effective"—though this is "a risky business, and not recommended to any pianist not as deeply steeped in the Mozart style as Mme. Landowska . . . the pieces on these discs are like a set of finely cut diamonds mounted so as to bring out every flash of blue-white color . . . the gems sparkle with a unique brightness."

**MUSSORGSKY: Pictures at an Exhibition.** Sviatoslav Richter, piano. Columbia ML 5600. Reviewed in November 1960, by Harris Goldsmith.

Mr. Goldsmith warns that this record is not recommended for its sonic qualities. It was taken from a public performance in Sofia—"the city was just recuperating from a severe flu epidemic at that time and the audience's wracking coughs are immortalized with virulent splendor . . . but in its noise-ridden grooves is enshrined the greatest piano performance of the *Pictures* I have ever heard, on records or off . . . the pianist is simply amazing here; the reading is utterly hypnotic in its dynamic force, its humor, and its staggering virtuosity." The "Goldenburg and Schmuyle" section is "pompous and imposing"; "Catacombs" and "*Con Mortuis in Lingua Mortua*" have "chilling impact." Summarizes Mr. Goldsmith: "Truly indispensable. Indispensable, too, is the great pianist who created it."

**ORFF: Der Mond.** Christ, Kuen, Hotter, Schmitt-Walter, *et al.*; Philharmonia Chorus and Orchestra, Wolfgang Sawallisch, cond. Angel 3567/B. Reviewed in August 1958, by David Johnson.

After a look at the somewhat befuddling Grimm Bros. fable which serves this opera for a plot, D.J. said: "As for the music, it is as translucent as the fable is muddy, as immediately appealing as Offenbach or Johann Strauss . . . superb writing for percussion instruments" [thirty-four of them]. Performance: "well-nigh flawless." Sound: "may well be the most stunning opera recording yet made."

This last judgment was supported by Conrad L. Osborne, whose review of the stereo version (July 1960) concluded that "in short, the job has been done to a turn." Whether or not Orff takes a place as a composer of enduring meaning, the Fifties have found him appealing. Of the many recordings which have spread his popularity, none serves him better than this.

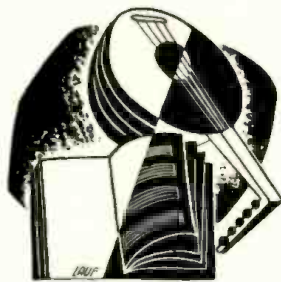

**PUCCHINI: Tosca.** Callas, Di Stefano, Gobbi, *et al.*; Chorus and Orchestra of Teatro alla Scala, Victor de Sabata, cond. Angel 3508 B/L. Reviewed in January/February 1954, by James Hinton, Jr.

"It would be rash to state categorically," conceded Mr. Hinton, "that this is the best job anyone has yet done of capturing a performance on discs; nonetheless, it may very well be just that . . . the defining excellence can be traced to Victor de Sabata . . . his is the master hand that shapes all into a white-hot theatrical experience." Callas' Tosca is "of the dark, smoldering, tempestuous kind . . . she always convinces, always communicates. No one woman has a right to be so gifted." Di Stefano is "electrifyingly better" than usual, Gobbi "big-voiced and commanding . . . brutal but capable of suavity when the need arises." Hinton summarizes by saying that "the whole effect is pretty tremendous."

From his December 1958 vantage

point, our Puccini discographer David Johnson gives the recording first prize among four versions available, contending that other contemporary Toscas are "but pale competitors" for Mme. Callas, that Gobbi is a "superb" Scarpia, and that Di Stefano is "a joy to the ear." Though two more editions have since appeared, and two others (Cetra) have reappeared, most will still give Angel pride of place.

**SCHUBERT: Die Winterreise.** Dietrich Fischer-Dieskau, baritone; Gerald Moore, piano. Electrola 90001/2 (originally released here on RCA Victor LM 6036). Reviewed in April 1956, by Philip L. Miller.

Writing less than a year after the noted baritone's New York debut (at Town Hall, with the same song cycle and same accompanist), Mr. Miller observed: ". . . he demonstrates his ability to sing the songs 'from within,' to balance good tones and admirable legato with scrupulous regard for Wilhelm Müller's text. Above all, he gives the impression that he is singing to you . . . the three preferable versions [of *Die Winterreise*] are sung with Gerald Moore at the piano . . . for each of them he brings a special set of details into relief . . . in Schumann's *Liederkreis* [Side 4 of the album] the baritone's singing is even more sheerly beautiful than in the Schubert."

Amid the flood of Fischer-Dieskau discs of the last five years, this one stands as perhaps his most characteristic and significant.

**SCHUMANN: Manfred, Op. 115.** Soloists; speakers; BBC Chorus; Royal Philharmonic Orchestra, Sir Thomas Beecham, cond. Columbia M2L 245. Reviewed in May 1958, by Harold C. Schonberg.

"Three poets." Mr. Schonberg reminded us "above all captured the imagination of Romantic composers—Shakespeare, Byron, and Goethe; and of the three, it was Byron who most inflamed them . . . Schumann idolized Byron. He had read *Manfred* in 1829 and . . . in 1848 he completed incidental music for the poem. . . . On first hearing." Mr. Schonberg continued, "the music may appear minimal. . . . One's attention is riveted on the rolling, sonorous voice of George Rylands. . . . When one replays the discs, the composer's commentary takes on more and more value. . . . This is Schumann at his most imaginative and his most delicate. . . . The recording is beautiful . . . [Beecham] leads a stirring, romantic performance . . . and he is fortunate in his flexible chorus and competent cast of singers and actors."

**SCHUMANN: Waldszenen, Op. 82; Fantasiestücke, Op. 12; March, Op. 76, No. 2.** Sviatoslav Richter, piano. Decca DL 9921. Reviewed in August 1957, by Harold C. Schonberg.

Like so many of his Soviet colleagues—Gilels, Oistrakh, Rostropovich, Lisitsian, *et al.*—Richter was first heard via Russian-taped performances somewhat below good Western sonic standards; this record, made in Prague by DGG, represented perhaps the first really adequate engineering the pianist had received. (His triumphant American concert tour of Fall 1960 was, of course, still well in the future.) Remarkd Mr. Schonberg: "I don't see how the *Waldszenen* could be played better . . . Richter, a forty-two-year-old Russian, is one of the greatest pianists of his generation, possibly the greatest. . . . Throughout, he displays poetry, strength, and simplicity, with a formidable ability to make the inner voices sing. The *Vogel als Prophet* comes out with a haunting, disembodied quality I have never heard duplicated."

**SIBELIUS: Concerto for Violin and Orchestra, in D minor, Op. 47.** Jascha Heifetz. Chicago Symphony Orchestra, Walter Hendl, cond. RCA Victor LM 2435, LSC 2435. Reviewed in October 1960, by Harris Goldsmith.

Heifetz first recorded this concerto in the 1930s with Sir Thomas Beecham and the London Philharmonic; his "characteristic virtuosity, his classical detachment and white-hot intensity, have always made his rendition a nonpareil. It is wonderful to have his thrilling performance available in up-to-date sound . . . the violinist now plays with greater coloristic variety than he did previously . . . and with greater nuance throughout . . . his command is still nothing short of phenomenal. . . ." Hendl's support H. G. regards as "superlative," though a "totally different conception" from Beecham's. In addition, "this is one of the best-sounding Heifetz recordings . . . the RCA engineers have produced a splendidly *musical* sound."

**STRAUSS: Ariadne auf Naxos.** Schwarzkopf, Seefried, Streich, Schock, *et al.*; Philharmonia Orchestra, Herbert von Karajan, cond. Angel 3532. Reviewed in January 1956, by James Hinton, Jr.

To J. H., Jr., who avows the "tenderest devotion" for *Ariadne*, "this is one of the most exquisitely lovely and desirable of all opera recordings." (He confesses that "others, less in love with the work itself, might be able to pick flaws.") "The thing that matters is that *Ariadne auf Naxos* holds some of the very

finest, most moving music Strauss ever wrote, as well as some of the most mischievously inventive . . . there is not much of what-we-please-to-call action . . . yet the interplay of personalities is so superbly balanced that there is not any question of loss of interest." As to the performance—Von Karajan: "magnificently proficient." Schwarzkopf: "some of her very best singing on records." Schock: "surpasses himself." Streich: "marvelously clean in her attacks and musical in her phrasing . . . may not eclipse Ivogün, but goes far towards emulating her." Seefried: "also excellent," for the "purity, the sheer musicality of her singing." The rest of the casting is "extremely generous and right," the recording "precise in balance, properly intimate in perspective."

**STRAUSS: Der Rosenkavalier.** Reining, Gueden, Jurinac, Weber, *et al.*; Chorus of the Vienna State Opera; Vienna Philharmonic Orchestra, Erich Kleiber, cond. London A 4404. (Released as LLA-2.) Reviewed in November 1954, by James Hinton, Jr.

"Even by stretching the imagination as far as it can be made to stretch," postulated Mr. Hinton, "it is hardly possible to imagine the day when this recording will lose its value." Our imagination can be made to stretch farther than six-and-a-half years; but to date, the prophecy stands. Some reasons: "The really remarkable thing about the performance is its unity of effect, its constant communication of theatrical pulse and flow . . . without hurry, without hesitation, Kleiber allows the whole score to sound." Reining (Marschallin): "warm, expressive, womanly"; Jurinac (Octavian): "all that could be hoped for"; Gueden (Sophie): "a complete and delightful vocal character"; Weber (Ochs): "in the Mayr tradition."

There have been challengers—strong ones, and in stereo—but C.L.O., reviewing the most recent of them (January 1960), concludes: "In sum, I'll still take Kleiber."

**STRAVINSKY: Pétouchka; The Rite of Spring.** Columbia Symphony Orchestra, Igor Stravinsky, cond. Columbia D3L 300; D3S 614. Reviewed in January 1961, by Alfred Frankenstein.

Some of the chief glories of the decade have been Igor Stravinsky's inimitable recordings of his own music. It is difficult to single out one from among these many historic issues, but Mr. Frankenstein was particularly glad to greet the above album, since *Pétouchka* was the only major work of the composer not available in his own reading. The composer's interpretation of *Pé-*

*touchka* is "quite unlike any other I have ever heard," reported Mr. Frankenstein. "Stravinsky seems to hear the whole of this score as if it were played on a vast concertina. . . . The feeling of squeeze-box music for a popular fair dominates everything. . . . The composer takes infinite care with the articulation of every phrase . . . he also takes great care with the soloistic, chamber-ensemble aspects of the orchestration." As to *Sacre du printemps*, "This great, vital, poetic, extremely violent performance has never previously been available in stereo, and stereo does well by an orchestration so elaborate. . . ."

**TCHAIKOVSKY: Concerto for Piano and Orchestra, No. 1, in B flat minor, Op. 23.** Emil Gilels, piano; Chicago Symphony Orchestra, Fritz Reiner, cond. RCA Victor LM 1969. Reviewed in January 1956, by John F. Indcox.

The first American recording by Emil Gilels (indeed, the first American recording by a Soviet artist) proved a happy successor to "all those emaciated-sounding early recordings . . . that managed to seep through the Iron Curtain." Our reviewer continued: "To make no bones about it, this is an astonishingly exciting and vivid performance, illuminated by the passion and power brought to it by soloist and conductor alike . . . the boldness of [Gilels'] attack is equaled only by the delicacy of his tone, and both are almost incredibly wonderful . . . from the crashing opening chords, it is evident that Gilels and Reiner have established a complete rapport, and this is wonderfully maintained throughout."

Some will certainly plump for Cliburn, or Horowitz, or Richter, or Rubinstein, but none will debate the stature of this reading.

**VERDI: "Verdi and Toscanini."** Milanov, Della Chiesa, Merriman, Peerce, Warren, Moscona; Westminster Choir; NBC Symphony Orchestra, Arturo Toscanini, cond. RCA Victor LM 6041. Reviewed in February 1957, by Max de Schauensee.

"What would some of us not give to hear how Clara Schumann played her husband's music?" asks Mr. de S. ". . . When the bicentenary of Verdi's birth is being celebrated, the nuclear and plastic age will not have to wonder how Verdi's music must have sounded as played by a man who knew and worked with the venerable composer. Of prime interest [in this two-record album] is the recording of the complete fourth act of *Rigoletto* [which] catches the excitement and interest of a great occasion" [the live Medi-

son Square Garden concert of May 25, 1944]. We can be glad to have a reading with "so uncompromising a responsibility towards the composer's intentions."

The album also includes the trio from *I Lombardi*, the chorus "Va, pensiero" from *Nabucco*, "Quando le sere al placido" from *Luisa Miller*, and Toscanini's authoritative reading of several Verdi overtures and the *Otello* dance music. Together with the *Rigoletto* Act IV, they constitute a presentation of unfailing musical interest as well as prime historical import.

**WAGNER: Orchestral Excerpts.**

(Music from *Rienzi*, *Der fliegende Holländer*, *Tannhäuser*, *Lohengrin*, *Tristan und Isolde*; *Die Meistersinger*, *Götterdämmerung*.) Philharmonia Orchestra. Otto Klemperer, cond. Angel 3610B; S3610B. Reviewed in October 1960, by Robert C. Marsh. Mr. Marsh reviewed this album in conjunction with Stokowski and Walter programs of Wagner, and had good things to say about all three conductors. "It is, however, the Klemperer album that demands the greatest respect. . . . the performances are extraordinarily fine, and the engineering projects them with an exceptionally wide dynamic range and some of the best stereo yet heard from the EMI organization. . . . in the Funeral Music from *Götterdämmerung* he affirms the German high-Wagnerian manner with an authority unrivaled since this music was conducted by Karl Muck. . . . the entry of the Meistersingers is commonly rushed in the concert room, and it is glorious to have it realized in its proper terms as a noble procession. . . . finally, in the two *Lohengrin* preludes one hears a lightness of touch, and open transparent ensemble quality, and a fresh and effortless sense of movement. . . . it would seem mandatory that Klemperer be given an opportunity to direct one or more Wagner albums in which at least complete scenes can be heard in the manner of the theatre."

**WAGNER: Das Rheingold.** Flagstad, Madeira, Svanholm, London, Neidlinger, Kuen, Böhme, Kreppe, et al.; Vienna Philharmonic Orchestra, Georg Solti, cond. London A 4340; OSA 1309. Reviewed in August 1959, by R. D. Darrrell. In a lengthy feature review, R.D.D. begs us to observe that "the inevitable hullabaloo over [the recording's] sonics may throw misleading emphasis on qualities that are only incidental. . . . the performance is emphatically first-rate. . . . top hon-Alberich and Flagstad's Fricka." ors are clearly won by Neidlinger's

Even the weakest cast members are given credit for "considerable competence," while Solti's direction is praised for "its complete freedom from mannerisms" and its "near-perfect control, balance, restraint, and power. The essential characteristic of the whole performance is an unremitting fidelity to the composer's expressly prescribed intentions." Audiophiles will get here "their fill of sonic frissons. . . . but sound effects as such are highlighted only when they are dramatically meaningful. A phonographic monument."

As the first (legitimate) complete *Rheingold* and the first operatic recording to demonstrate the highest possibilities of high-fidelity stereophonic sound—as well as an eloquent performance in its own right—the album is assuredly a landmark.



**WAGNER: Tristan und Isolde.** Flagstad, Thebom, Suthaus, Fischer-Dieskau, Greindl, et al.; Chorus of the Royal Opera House, Covent Garden; Philharmonic Orchestra. Wilhelm Furtwängler, cond. Angel 3588 E/L (originally released in this country as RCA Victor LM 6700). Reviewed in November/December 1953, by James Hinton, Jr.

While conceding that the performance is "not unexceptionably perfect," J. H., Jr., nonetheless maintained that "there are elements here that will not fade with the passage of years, and the total accomplishment. . . . is tremendously valuable." Mme. Flagstad, whom Mr. Hinton proposed be measured by "no standard but the very highest," is "completely in control, and only a little less magnificent than her own superb best. . . . in the second act she is tremendous, and her *Liebestod* matches those of her great final Isolde at the Metropolitan." Of Furtwängler's leadership: "Nothing short of magisterial. . . . always controlled and large in conception." Of the other elements, Thebom (Brangäne) and Fischer-Dieskau (Kunwenal) received especial praise.

Mr. Hinton re-reviewed the set in a Wagner discography of April 1955, at which time he called it "one of the very best opera recordings ever made," and remarked that it received "absolutely no contest at

all" from other versions. That has remained the situation to this very day—the arrival of a new challenger is detailed on page 89 of this issue.

**WEBERN: Complete Works.** Orchestral, vocal, and chamber ensembles, Robert Craft, cond. Columbia K4L 232. Reviewed in May 1957, by Alfred Frankenstein.

This "epical undertaking," as Mr. Frankenstein described it, "will remain for a very long time as one of the major monuments" of recorded music. The discs, arranged chronologically, encompass Anton Webern's entire lifework. "Webern consistently sought the highest degree of intensity within the minimum span of time. His craftsmanship was infinitely involved and he would not be hurried; the thirty-three works on the records required thirty-seven years for their composition. As a result, each is a unique event. . . . "Performances and recording," he concluded, "are equally fine. One cannot mention all the participants, but one should at least single out Marni Nixon and Grace-Lynne Martin, whose singing of the numerous songs. . . . is especially noteworthy."

**WEILL: Die Dreigroschenoper.**

Lotte Lenya, Trude Hesterberg, Johanna von Koczian, Willy Trenk-Trebitsch, Erich Schellow, Wolfgang Grunert, Wolfgang Neuss, et al.; Gunther Arndt Chorus; Sender Freies Berlin Orchestra. Wilhelm Brückner-Rüggeberg, cond. Columbia 02L 257; 02S 201. Reviewed in November 1958, by Carl Michael Steinberg. "Five years ago," observed C.M.S., "it would have been necessary to explain at length the history of *The Threepenny Opera* and its creators. . . . now, as I write, [it] is about to go into its fourth year at the Theatre de Lys, and [its] stature is no longer a fancy in the minds of a few intellectuals and a handful of German refugees. We have here one of the few masterpieces of our time, and we have it in a wonderful recording. . . . the senior Peachums (Trude Hesterberg and Willi Trenk-Trebitsch) are wonderful. Erich Schellow (Macheath) can hardly sing at all, but his grasp of the part seems ideal. . . . Lenya remains a great and fascinating theatrical personage."

Cultural histories of America in the '50s cannot ignore the phenomenal revival of the Brecht/Weill collaborations. *The Threepenny Opera* is now well into its sixth year on Greenwich Village's Christopher Street, and this complete-to-the-last-bar recording, supervised by Weill's widow (and most idiomatic interpreter), is its most distinguished recorded monument.



# SPECIAL PREPUBLICATION OFFER...

**HIGH FIDELITY**  
readers save \$1  
by ordering now!

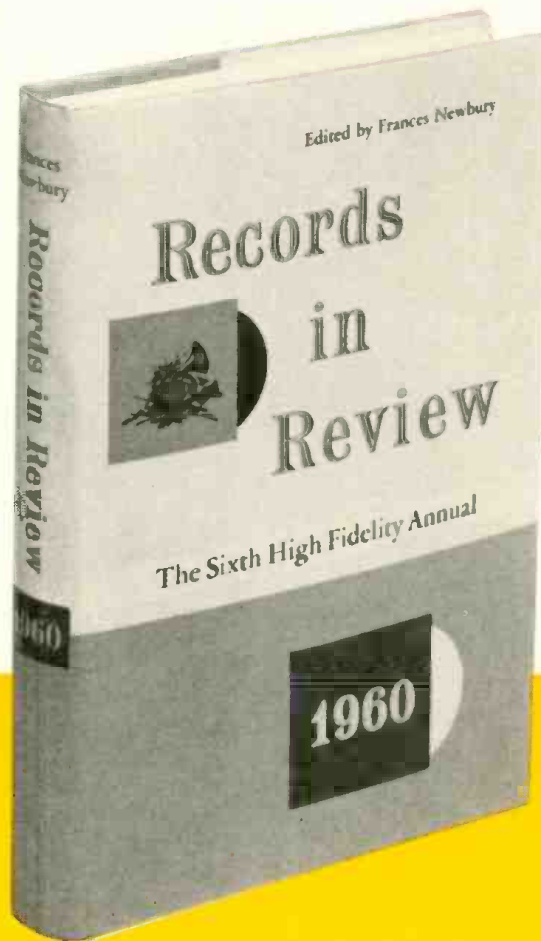

## Records in Review—1960 . . .

now in preparation, will bring you in one convenient book hundreds of reviews of stereo and mono records and stereo tapes which appeared in High Fidelity Magazine from July 1959 through December 1960—classical and semiclassical music exclusively.

This hardcover book of approximately 300 pages, edited by Frances Newbury, will save you countless hours in the listening booth. And it will help you build a distinguished collection of music YOU enjoy. It is the most complete and authoritative book of its kind—the standard reference work that gains in value as the years roll by.

Each reviewer stands high in his field—Nathan Broder, for example, reviews Bach and Mozart, Alfred Frankenstein the moderns . . . Paul Affelder covers the romantics, Robert C. Marsh specializes in Haydn and Beethoven . . . Conrad L. Osborne writes on opera recordings, R. D. Darrell on tape releases. Forthrightly, they discuss the composition, performance and fidelity. And they compare the new recordings with earlier releases.

You'll find the reviews organized alphabetically by composer for quick, easy reference—and in the case of composers frequently recorded, further sub-

divided by such categories as Chamber Music, Vocal Music, etc. You'll find, too, a special section on Recitals and Miscellany, and Tape, and an Index of Performers.

*Records in Review—1960*, the Sixth High Fidelity Annual, is scheduled for publication June 1, 1961, at \$5.95. **But you can order your copy now—for shipment the moment it comes off press—at the special prepublication price of only \$4.95!** Payment with order—but satisfaction guaranteed, or your money back!

The Wyeth Press, a Division of High Fidelity  
The Publishing House, Great Barrington, Mass.

Send me as soon as published RECORDS IN REVIEW—1960 at the special prepublication price of only \$4.95. I enclose payment.

Name \_\_\_\_\_

Address \_\_\_\_\_

City \_\_\_\_\_ Zone \_\_\_\_\_ State \_\_\_\_\_

Foreign orders sent at buyer's risk. Add 25c for postage on foreign orders except Canadian.

POINTING 10 YEARS AHEAD



WHEN "HIGH FIDELITY" BEGAN...

A decade ago, Garrard research had already produced the RC80, an instrument advertised in the first issue of this magazine, and so advanced that it established the standard for all high fidelity record changers.

POINTING 10 YEARS AHEAD TODAY...THE FIRST AND ONLY

# AUTOMATIC TURNTABLE GARRARD'S LABORATORY SERIES TYPE A

The step beyond the turntable...the step beyond the changer...The Type A is an entirely new kind of record-playing unit. It combines, in a single instrument, a dynamically-balanced tone arm; a full-sized 6 lb. cast turntable; a completely shielded, laboratory-balanced motor; plus the safety and convenience of the world's finest automatic record-changing mechanism (Garrard's pusher platform) to use when you wish. The Type A tone arm is unique, being the only true dynamically-balanced arm on an automatic unit. It has a sliding counterweight and a built-in calibrated scale

to set and insure correct stylus tracking force. You may use any cartridge, whether designated as professional or otherwise, with assurance that this arm will track the stereo grooves perfectly at the lowest pressure recommended by the cartridge manufacturer. Only the Garrard Laboratories, unmatched in facilities and with 40 years of experience, could have developed this advanced, precision instrument. It is here today...the keystone of tomorrow's finest component music systems. Garrard Laboratory Series Type A, \$79.50.

FOR COMPARATOR GUIDE, WRITE DEPT. GD-21, GARRARD SALES CORP., PORT WASHINGTON, N.Y.



*The consumer's guide  
to new and important  
high-fidelity equipment*

high fidelity

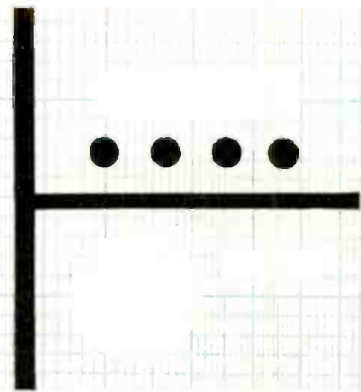

## EQUIPMENT REPORTS

**AT A GLANCE:** The Scott LT-10 is a high performance FM tuner. Its availability only in kit form should not dismay the nontechnically minded, since construction has been simplified to an extraordinary degree. Satisfactory alignment can be performed using only the meter in the tuner. The procedure is spelled out in the construction notes and, if carefully followed, will enable even the amateur builder to meet the manufacturer's specifications. Its low distortion, easy tuning, low drift, and simple construction make the LT-10 an excellent value. Price: \$89.95 (east of the Rockies).

**IN DETAIL:** Four LT-10s were put together by HIGH FIDELITY staff members and all report extreme ease of construction and highly satisfactory performance. Fastest actual construction time was eight hours (at an easy pace) including final assembly and alignment. All agree that the unique packaging and simplified step-by-step procedure make the LT-10 an easy task for the builder with no experience at all.

The kit's heavy cardboard shipping carton opens into a contained work area. Should the builder stop work for any reason, the carton can be closed like a suitcase and put aside with all components safely in place. This handy storage idea makes construction as feasible in the living room as in a basement workshop. No mess. Precut and pretinned wires speed the job along. And the division of components into individual "assembly groups" relieves the kit of even the appearance of complexity. Each group is mounted on its own special card with as few as six and not more than eleven construction steps to each. The construction manual's four-color diagrams, one for each assembly group, illustrate only that section of the chassis relating to the step under construction. This again removes any suggestion of complexity.

On the opening page of the electrical assembly, one is told to "read completely and carefully." This advice, no matter how experienced the builder, is not to be taken lightly. One HIGH FIDELITY builder panicked at finding some omissions in the numerical sequences of "assembly group" cards. He thought the parts were missing. The truth is, and it is clearly stated in the manual, that some "assembly groups" have no card of parts (the hook-up of leads from the transformer, for example).

Another builder (myself) gave only a cursory look at step B-12-7 and soldered a diode in backwards. The instruction plainly states "Connect the red end of a diode to pin 2, S6." I connected the yellow end. In kit building one can be overconfident. The only true method is to follow instructions.

A special word of praise is due the manufacturer for Chart A-2. This diagram shows the number of soldered connections that go to each terminal and enables the builder to cross-check the finished wiring in a hurry. For one HIGH FIDELITY builder, this chart uncovered a single, simple (but important) error—an unsoldered connection among several wires at the same terminal. The manual anticipates such oversights.

With the tuner completely assembled, the builder is ready for the simple alignment procedure. Even without alignment, my unit pulled in a number

### H. H. Scott LT-10 FM Tuner Kit



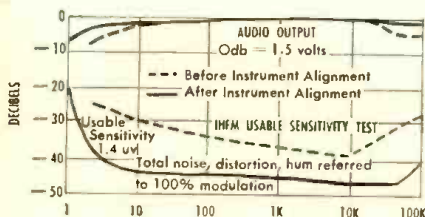

of signals, albeit, noisy. In fact, the tuning dial just happened to be set dead center on one of the strongest signals, a circumstance that provided an extra fillip to turning the unit on for the first time. Alignment is simple. The alignment tool, a plastic rod with a slotted (screwdriver) end for IF transformers and a hexagonal end for the detector transformer, is used in conjunction with the tuning dial to achieve a maximum signal strength reading on the front panel meter. As alignment proceeds, signal strength builds and noise and distortion diminish markedly. This part of the job is fun; it imparts a real sense of discovery. The entire process took less than a half hour and, upon completion, my unit pulled in about fifteen stations in a weak signal area using only the dipole antenna wire supplied.

The instruction book provides a "Service Hints" section where "Laboratory Alignment Instructions" are provided. Curious to see how laboratory alignment would compare with do-it-yourself aligning, we shipped our test unit to Hirsch-Houck Labs. They found that instrument alignment could improve upon even the very fine manufacturer's specifications. For example, the H. H. Scott specification for sensitivity is 2.5 microvolts for 3 per cent distortion (IHFM Standard). Hirsch-Houck Labs. was able to get 1.4 microvolts. (Instrument alignment on the LT-10, we found by calling a reputable audio service shop, can be performed for under \$10.)

Said Hirsch-Houck, "There can be little doubt that these kits will meet specifications handily. For any signal stronger than a few microvolts (barely enough to move the tuning meter) the distortion is entirely negligible, of the order of 0.5 per cent at 100 per cent modulation. Hum was 57 db below 100 per cent modulation.

"In other characteristics, the LT-10 showed up equally well. Capture ratio was 5 db. Drift from a cold start was less than 40 kc and occurred gradually over a fifteen-minute period. Frequency response was within plus or minus 1 db from 20 to 20,000 cps. Output was 1.5 volts at 100 per cent modulation."

In summing up, Hirsch-Houck Labs. commented that "the most remarkable feature of the tuner's performance was the fact that it came from only five tubes, plus rectifier and a pair of detector diodes. Not long ago, tuners with twice the tube complement could only approach this performance. It sounds as good as it measures, and that is the highest compliment one can pay."

R.F.

## A.E.S. Gigolo Speaker System



**AT A GLANCE:** The A.E.S. Gigolo is a "bookshelf"-type speaker system available by direct mail with a stated money-back guarantee.

Measurements and listening tests indicate that the Gigolo is—for its size and price—a fairly good buy for use in a budget system, as a "second speaker" in a playroom, and for similar "secondary" applications. Price: \$15.

**IN DETAIL:** The Gigolo is housed in a sealed box, 24 inches by 12 inches by 9½ inches, made of pressed composition board ¾-inch thick. We took the back off one unit and found that the interior contained a quantity of spun orlon, an absorbent material. The speaker itself was an 8-inch R & A, made in England, and rated—according to its label—at 10,000 gauss.

The cone is ribbed toward its center and has a chemically treated edge suspension. Its center is fitted with a stiff, smaller cone to aid treble dispersion, although both cones apparently work off the same voice coil. The larger cone is fairly compliant, and its useful axial displacement was judged to be somewhat above ¼-in. Working impedance, not stated, was estimated to be 8 ohms. Speaker leads run to terminals on the enclosure's back.

In tests, the Gigolo measured and sounded quite good for its size and cost, though no acoustic miracles were perceived. The results of five separate measurements made at Hirsch-Houck Laboratories indicated that "the middle frequencies from 200 to 2,000 cps are elevated in response slightly, with cyclic variation of plus or minus 5 db in this range. Above 2,000 cps, the axial response is smooth out to 15 kc, where we terminate our measurements. Off axis, the speaker showed the expected directive effects, but the beaming of high frequencies is not particularly audible unless one moves about in front of the speaker listening for them."

The sound in this 2- to 15-kc region, judging by the most critical of standards,

could best be described as tight and bright, with an occasional suggestion of "boxiness," but generally fairly pleasant. This appears to be related to its transient response, indicated by the tone-burst picture taken at 3.5 kc. While not outstandingly good, this pattern does not show any sign of "birdies" or other spurious response.

Response at the bass end, particularly with high level program material, was not as favorably received. According to our lab report, "the effective lower limit of the Gigolo's response is at 100 cps, with response falling 12 db/octave starting at 200 cycles. Bass boost is not feasible to correct the response, since the speaker's distortion rises rapidly below 100 cps. At lower levels, some bass boost can be tolerated, particularly if boost starts at 200 to 300 cps. Not all amplifiers, however, have such a bass boost characteristic."

We found that positioning the speaker in an acoustically good corner gave a somewhat fuller bass response than the raw measurements imply, though nothing like the deep effects suggested by response in the 20-cycle region. In explaining the fact that on most programs the speaker "does not sound as far out of acoustic balance as it actually is," Hirsch-Houck Laboratories suggested that "likely, its distortion at low frequencies, which includes several harmonics, has the effect of fooling the ear into re-creating the fundamental bass tones."

As with gigolos of popular lore, the present speaker of that name operated best with some outside help. Thus, a high performance tweeter, crossed over at 2,000 cycles, brightened and clarified the high-end response. And a husky woofer, as expected, fortified things below 200 cycles. Considered on its own merits, the Gigolo at \$15 is a very satisfactory buy, assuming that the buyer knows what it can and cannot do. A final word: the boys at the lab (our lab, that is) recommend using it with amplifiers not exceeding 20 watts, since in their view the speaker is quite efficient and might be damaged by a high-powered amplifier.

N.E.

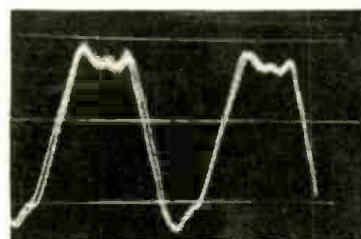
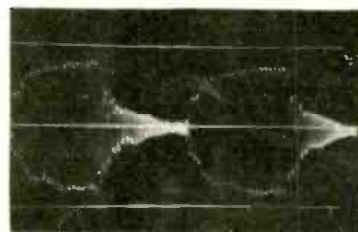
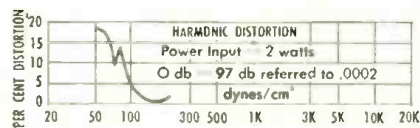
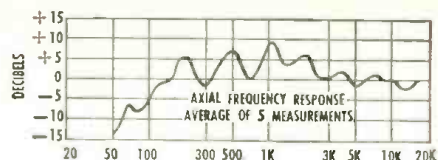

**AT A GLANCE:** The Tandberg Series 6 is a compact quarter-track stereo recording and playback unit, designed for installation in home systems. It has built-in preamplifiers, designed to drive the control amplifiers of a home music system.

While resembling earlier Tandberg recorders in many ways, the Series 6 has a greatly simplified control system. It is easier to operate than was the Series 5, yet retains the technical virtues of that excellent machine. Price: \$498.

**IN DETAIL:** A recorder designed for custom installation is necessarily different in its control functions from a portable machine, which usually has small playback amplifiers and speakers and in which provision for interconnection with a home system, if provided at all, is usually treated as an afterthought.

The Tandberg Series 6 meets the requirements for home installation and performance very adequately. It has low level and high level inputs and output jacks for each channel on the rear panel of the unit. On the main deck are two microphone jacks. Plugging in a microphone disconnects the rear input circuits.

Concentric recording-level knobs work for all inputs. Recording levels are shown by dual eye tubes (EAM86) which give very clear, unambiguous indications. Separate playback heads and amplifiers are regulated by a pair of concentric playback level controls. Thus, the machine is especially useful with the growing number of control amplifiers having tape monitor switches, which allow the program to be monitored off the tape as it is being recorded.

All the heads are four-track. This enables the user to record or play back either half-track or quarter-track stereo or mono tapes without shifting head position. A row of four push-button switches on the recorder panel permits independent control of each recording amplifier and each playback amplifier. By proper operation of these switches, one can perform mixing and sound-on-sound recording operations as well as the more usual modes.

The recorder is housed in an attractive teak cabinet measuring 16 in. by 12 in. by 6 in., and weighing 25 pounds. It may be mounted horizontally or at any angle up to 85 degrees from the horizontal.

The "T-handle" control of older Tandberg machines is retained on the Series 6, and we still find it a logical and simple type of tape transport control.

## Tandberg Series 6 Tape Recorder



Moving it to right or left places the tape in fast forward or rewind respectively, and pulling it toward the front of the machine sets the unit for normal forward speed. A separate start-stop button on the deck puts the tape into instantaneous motion, once the T-handle has been properly positioned. A separate lever selects the three speeds,  $7\frac{1}{2}$ ,  $3\frac{3}{4}$ , and  $1\frac{1}{8}$  inches per second.

Some time is required for the motor to come up to speed when the T-handle is operated. Due allowance must be made for this when starting operation, or the beginning of the recording will show effects of gradual acceleration. At least fifteen seconds, preferably more, should be allowed for the motor to reach operating speed.

An indexing counter and a separate on-off switch for the entire machine complete the operating controls.

On our test unit, we found a difference in the high frequency recording equalization between the two channels. The record/playback curves show the amount of the difference at  $7\frac{1}{2}$  ips; it is roughly similar at the other speeds. In general, the response of the Series 6 is excellent, extending to nearly 20 kc at  $7\frac{1}{2}$  ips. Low frequencies roll off slowly below 100 cps, but not perceptibly. The notch at 60 to 70 cps appears only at  $7\frac{1}{2}$  ips, and we are uncertain whether this is intentional. It appears on both channels. The playback equalization is excellent, being within 2 db of the NARTB curve from 50 to 15,000 cps. The NCB Alignment tape was used for this test, and similar results were obtained with the Ampex 5563-A5 tape up to 10 kc.

Like the Tandberg Series 5, the Series 6 has a remarkable signal/noise ratio. It was 51 db on one channel and 60 db on the other, and was essentially all noise. Hum can be neither heard nor measured (with our equipment) in the output of this unit.

Harmonic distortion figures are quite similar to those of the Series 5, being 1% or less at usual recording levels and reaching 2% to 3% at peak (eye-closing) levels. Wow measured 0.02% at  $7\frac{1}{2}$  and  $3\frac{3}{4}$  ips, and 0.03% at  $1\frac{1}{8}$  ips. Flutter was 0.12% at  $7\frac{1}{2}$  ips; 0.17% at  $3\frac{3}{4}$  ips; and 0.3% at  $1\frac{1}{8}$  ips. These are similar to the test results obtained on the earlier Tandberg 5 and approach the performance of professional equipment.

The fast forward and rewind speeds are such that 1,200 feet of tape can be handled in 85 seconds. The operation of the mechanism is smooth and the tape cannot be damaged. Automatic stop is possible if a metallic tape leader is used. The record amplifier control buttons are interlocked with the T-handle control, so that they cannot be pressed unless the tape transport is in an off condition. Accidental erasure of a tape is impossible.

The Tandberg Series 6 is a worthy successor to the older Tandberg machines, and is ideally suited to custom installations. Listening tests confirmed our measurements completely. Tape hiss is low and hum is nil. A slight brightness is added by the recorder, clearly heard in A-B comparisons, due to the rise in the high end. Over-all sound is clean and smooth. H. H. LABS.

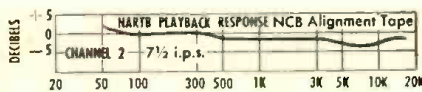
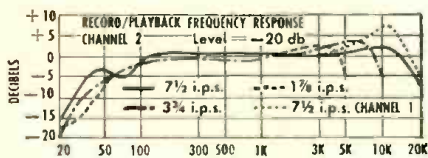

## McIntosh MR-65 FM Tuner

**AT A GLANCE:** The McIntosh MR-65 is a high performance FM tuner with a unique tuning system which is extraordinarily foolproof. It is virtually impossible to tune it and get less than its full performance. The MR-65 is rated with exceptional conservatism, and its construction resembles that of professional electronic equipment. Price: \$225.

**IN DETAIL:** The rated sensitivity of the MR-65, by IHFM Standards, is  $3\frac{1}{4}$  microvolts. Our measurements showed it to be  $3\frac{1}{2}$  microvolts, which is well within the limits of experimental error. McIntosh rates the distortion at less than 3% (-30 db) at 100% modulation, pointing out that the best commercial signal generators are not guaranteed to have less than this amount of distor-

## REPORT POLICY

Equipment tested by High Fidelity is taken directly from dealers' shelves. We report only on regular production-line models. The choice of equipment to be tested rests with High Fidelity's editorial department. Most equipment reports appearing here are prepared for us by Hirsch-Houck Laboratories, a completely independent organization whose staff was responsible for the original Audio League Reports. A few reports are prepared by members of the High Fidelity staff or by other independent testing organizations working under the general supervision of Hirsch-Houck Laboratories. All reports are signed.

tion. Our tests show it to have 0.5% (-46 db) distortion, a figure typical of measured values of better FM tuners.

The capture ratio (ability to reject an interfering station on the same channel with the desired station) is exceptionally good. It is rated at 3 db, and measured at 3.5 db. Hum was measured as down 61 db from the 100% modulation level. This is extremely low and very likely represents the limitations of our signal generator.

The frequency response, rated at within 2 db from 20 to 20,000 cps, was measured to within 1.7 db from 20 to 20,000 cps. The frequency drift without AFC is rated at less than 25 kc. We found a maximum drift from a cold start of 15 kc, four minutes after turning the set on, which reduced to about 3 kc after 15 or 20 minutes.

These measurements indicate a tuner that is certainly among the better ones on the market, and one which is rated with honesty and conservatism. In using the MR-65, one soon discovers that it handles much differently than other tuners. The MR-65 has two discriminators: one is a wide-band type for low distortion and good capture ratio, and the other is a very narrow band type for operating the AFC circuit. The AFC has a very long time constant, at least 3 or 4 seconds. This means that a station can be tuned in with the aid of the tuning meter just as if there were no AFC, without a tendency to lock on to an adjacent station. Then, after the tuning is completed, the AFC slowly takes hold.

The amount of AFC action is adjustable with a front-panel control, from none to an unusually large amount. With full AFC action the tuning error is reduced 15 times. This means that the tuner can be set to any point on the dial at which some indication of a station shows on the signal meter and will then unerringly tune itself to the correct frequency. There are two tuning meters, one showing signal strength and the other a center tuning indicator. With the AFC action of the MR-65, the latter is superfluous in normal use.

Using AFC, we found it impossible to tune the MR-65 in any way which would increase distortion beyond its minimum level. The importance of this can only be appreciated when one has tuned many other tuners while observing the distortion in the output. It has been our experience that most tuners cannot be tuned for minimum distortion by ear or by tuning indicator alone, though fortunately the audible effects of this slight "mistuning" are not serious on the better tuners.

The MR-65 model we tested was found to be sensitive to line voltage changes. Without AFC, a 105- to 125-volt line voltage shift changed the tuner frequency 125 kc. Of course, the use of full AFC correction reduces this to a negligible change of about 8 kc. For this reason, as well as those mentioned previously, we recommend using the AFC on this tuner.

In terms of construction, the MR-65 is exceptional. The chassis is heavy and chrome-plated. The flywheel tuning is as smooth as any we have used, and is free from backlash. The tubes have black heat-reducing shields, which give cooler tube envelopes and resulting long tube life and reduced drift. The wiring under the chassis is meticulous, with cables carefully laced and dressed.

The MR-65 has a function switch which provides for future stereo use with a multiplex adapter, space for which is provided on the chassis. For AM/FM stereo (with an external AM tuner), the AM tuner output may be connected to a jack on the MR-65 and switched by its function switch. There are also terminals for connecting the antenna leads of a TV receiver, if one chooses to use a common antenna for TV and FM. In such an installation, the antenna feeder is switched automatically to the TV receiver when the MR-65 is turned off.

The squelch, or muting circuit, of the MR-65 is switchable from the front panel. It works flawlessly, with absolutely no thump or other extraneous sound. Like other McIntosh components, the MR-65 has a switch which gives a choice of two degrees of brilliance of the dial illumination. A convenience outlet, rated for 350 watts, allows an amplifier to be controlled from the tuner.

In the McIntosh MR-65, we see an emphasis on conservative design and professional caliber construction, combined with utmost tuning ease and foolproof operation. The result is most satisfactory, and suitable for the finest receiving systems. What's more—because of its foolproof tuning, the MR-65 would be an especially good choice for use in a system that will be subject to less than very good care.

H. H. LABS.

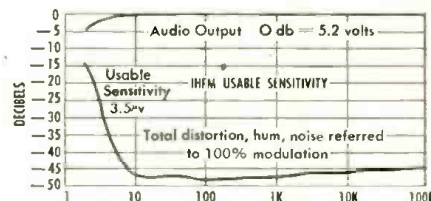
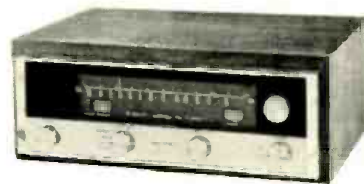

COMING IN THE MAY ISSUE

**Bozak 302-A Speaker System**  
**Shure M7/N21D Stereo Cartridge**

# A Salute to High Fidelity on its Tenth Anniversary

Columbia Records is proud to have introduced the long-playing microgroove record which High Fidelity has helped to make known.

## THE SOUND OF GENIUS

- Beethoven: Complete String Quartets  
The Budapest String Quartet
- Beethoven: The Nine Symphonies (also in stereo)  
Bruno Walter conducting
- The Birth of a Performance  
Bruno Walter conducting
- The Casals Festival Series (beginning with 1950)  
Pablo Casals, director
- The Art of the Organ  
E. Power Biggs, organist
- Handel: Messiah  
The Philadelphia Orchestra,  
Eugene Ormandy, conductor, and  
The Mormon Tabernacle Choir
- Berg: Wozzeck  
Soloists and the New York Philharmonic,  
Dimitri Mitropoulos, conductor
- Lulu  
Production of the Vienna State Opera,  
Herbert Häfner, conductor
- Schoenberg: Moses and Aron  
Orchestra and Chorus of the Norddeutscher  
Rundfunk, Hans Rosbaud, conductor
- Stravinsky: The Rake's Progress; Canticum Sacrum;  
Agon; Threni  
Igor Stravinsky conducting
- Webern: Complete Works  
Robert Craft conducting
- Ives: Second Symphony  
New York Philharmonic,  
Leonard Bernstein, conductor
- Modern American Music Series—  
works by Antheil, Barber, Berger, Bowles,  
Brant, Carter, Chanler, Copland, Cowell,  
Creston, Dello Joio, Finney,  
Glanville-Hicks, Haieff, Harris,  
Hill, Hovhanes, Imbrie, Kirchner,  
Lopatnikoff, McPhee, Mennin, Palmer,  
Persichetti, Ruggles, Schuman, Seeger, Sessions,  
Shapero, Thomson, Trimble, Weisgall, Wolpe.

## THE SOUND OF HISTORY

- I Can Hear It Now—Edward R. Murrow—4 Volumes  
Legacy Collection—The Revolution—The Confederacy—  
The Union
- Columbia Literary Series—W. Somerset Maugham, Aldous  
Huxley, John Collier, Sacheverell Sitwell, John Steinbeck,  
Katherine Anne Porter, William Saroyan, Edith Sitwell,  
Christopher Isherwood, Truman Capote, Edna Ferber and  
Sir Osbert Sitwell read from their own works.
- World Library of Folk and Primitive Music—edited by  
Alan Lomax. Music from Ireland, England, France, Scotland,  
Spain, Yugoslavia, Canada, Venezuela, India, Indonesia,  
Japan, Australia, New Guinea and Africa.

## THE SOUND OF BROADWAY

- Original Cast Recordings
- South Pacific—Rodgers and Hammerstein—Mary Martin and  
Ezio Pinza
- West Side Story—Bernstein and Sondheim—Larry Kert and  
Carol Lawrence
- The Sound of Music—Rodgers and Hammerstein—Mary Martin
- My Fair Lady—Lerner and Loewe—Rex Harrison and  
Julie Andrews—The best-selling (LP) album of all time.  
and
- Porgy and Bess—Gershwin—Lawrence Winters and  
Camilla Williams—The first and only complete recording.

## THE SOUND OF JAZZ

- Benny Goodman Carnegie Hall Jazz Concert—1938
- The Thesaurus of Classic Jazz—4-volume set featuring Miff Mole,  
Red Nichols, Bix Beiderbecke, Frankie Trumbauer and the  
Dorsey Brothers.
- Newport Jazz Festival—beginning with 1956, featuring Duke  
Ellington, Dave Brubeck, Louis Armstrong, J. J. Johnson and  
Mahalia Jackson.

## THE SOUND OF SINGING

- Sing Along with Mitch—The best-selling album series of all time.

© Columbia, LP, MarCAS Reg. Printed in U.S.A.

CIRCLE 35 ON READER-SERVICE CARD





# MusicMakers

by ROLAND GELATT

WHERE have we been? Where are we going? The questions spring inevitably to mind on the occasion of an anniversary—and they seem especially pertinent when applied to the American record industry, which has been in a state of chronic transformation during HIGH FIDELITY'S first decade. To seek out some of the answers, we chatted recently with two men at the top—Columbia's Goddard Lieberson and RCA Victor's George R. Marek.

The most far-reaching development of these last ten years—both executives agreed—has been the “democratization” of the long-playing disc. In 1951 the sale of records (except for pop singles) was still very much of a “class” business. Album-length recordings (whether of the old 78- or the new 33-rpm variety) were bought by a tiny minority of the population—mostly upper-middle-class college graduates. These customers patronized record dealers who offered good stocks, comfortable listening booths, knowledgeable advice, and list prices. Within a decade the situation had changed enormously. Today, the sale of records is a “mass” business. Everybody (well, almost everybody) has a phonograph, and the LP record is as common a commodity as soap flakes. The record dealers—those that are left—have turned into supermarkets, and the supermarkets have turned into record dealers. An interest in classical music is no longer looked upon as an aberration; in fact, it is now considered good form to like Tchaikovsky.

The big change really began in 1955, when RCA Victor slashed two dollars off the list price of LPs (other companies soon followed suit) and when Columbia started its mail-order record clubs (ditto). These two actions, many observers believe, contributed to the disintegration of the independents—Haydn Society, Dial, Period, *et al.*—and to the decimation of the regular record dealers, by forcing down the profit margin of the former and luring away the customers of the latter. Needless to say, the

Messrs. Marek and Lieber-son do not entirely agree with this interpretation of past history. The independents, says RCA Victor's general manager, would have found the going rough even without the slash in prices. Marek holds that people bought “early Haydn symphonies” (a catch-all example for the independents' generally esoteric repertoire) as long as there wasn't much else to buy on LP; when the customers had more to choose from, the demand for off-beat fare diminished. As for the small record dealers, Columbia's president maintains that the clubs hurt only those stores that were ineptly run—the intelligent, alert dealers survived and are doing more business than ever, the others were doomed from the start.

Despite casualties along the way, the process of “democratization” has vastly increased the audience for recorded music. Goddard Lieberson believes that really two audiences exist—and hence two different record businesses. One is a mass marketing business, akin to the distribution of cigarettes or toothpaste. The aim is to reach as many people as effectively as possible—hence the mail-order clubs, the supermarket racks, the tie-in sales. The other is a connoisseur business, akin to hard-cover book publishing. The aim is to meet the needs of a comparatively small, sophisticated, faithful audience and to reach it through specialized dealers. Sometimes the two businesses find a common meeting point; repertoire that appeals to one kind of buyer will also on occasion appeal to the other. But it is important, says Lieber-son, not to confuse the two businesses. And it is also important not to apply the same profit criteria to the connoisseur business that are pertinent to the mass business. A large record company, Lieber-son insists, has a duty to put out certain culturally significant recordings simply because they need to be made available. Columbia publishes the complete works of Anton Webern for the same reason that Alfred A. Knopf publishes the poetry

of Wallace Stevens. The publisher in either case hopes to break even, but that is not the chief consideration.

George R. Marek sees not two businesses but one pyramid. The broader the base of the pyramid, the more room on the top. Already there are signs that the mass market at the base is providing more listeners at the top. RCA Victor has comparative sales figures to show that a work such as Mozart's *Marriage of Figaro* finds more record buyers today than five years ago. America is in a continual process of trading up. We go from pretzels to Beluga caviar, from Robert Hall to J. Press, from the *1812 Overture* to the B minor Mass.

The two executives hold differing views on stereo. Marek feels that the stereo disc was introduced at the right time and in the proper way, and he is convinced that its richer sound is contributing mightily to the expansion of the classical business, particularly in the opera repertoire. Lieber-son believes that stereo was launched prematurely and that the industry should have backed the development of a “compatible” disc. He has, moreover, grave doubts about the importance of stereo in the classical repertoire (though he admits its undeniable effectiveness as a sonic adjunct in the pop field).

They are in agreement as to obsolescence. Both deplore the public's tendency to buy records on the basis of newness rather than intrinsic musical quality. They wish it were easier to sell yesterday's great performance to today's customer.

Finally, they are in agreement about the future. It will be rosy. Sound will continue to improve; equipment will become easier to handle and will consume less space; new artists will throw fresh light on familiar masterpieces; important new music will be composed and fascinating old music rediscovered; the ranks of the discriminating listener will grow ever larger. In short, if we interpret our two informants aright, the outlook for the next decade in the recording industry is decidedly bullish.

You will proclaim the new Audio Fidelity Percussive Jazz albums the greatest examples of engineering sound reproduction skill you have ever heard on any label!



PERCUSSIVE JAZZ, Vol. 2... The thrilling ricochet sound in the swinging, modern jazz idiom. Specifically designed to highlight ultimate stereo "directionality," maximum signal, balance, and definition. Outstanding arrangements by Sid Cooper. Better than anything else you have heard in percussive high fidelity!

DFM 3007/DFS 7007



VOL. 2  
**PER-CUS-SIVE**  
\*Moanin', Fever and other  
Swingin' Hip Tunes  
**JAZZ**

Doctored  
for  
Super-  
Stereo

Moanin'  
Fever  
Tender Trap  
Just in Time  
Everything's Coming Up Roses  
and others

# AUDIO FIDELITY® NEW RELEASES!

CUT OUT  
THIS  
LABEL



THIS IS THE  
NEW AUDIO FIDELITY  
STROBOSCOPIC LABEL

The strobe-pattern on the record label when viewed under a 60 cycle neon or fluorescent light source should remain in position if the turntable speed is correct. If there is a marked "walking" of the stroboscopic pattern the turntable is off speed.

TO  
CHECK  
YOUR  
TURNTABLE  
SPEED

At last, more Bawdy Songs by Oscar Brand on a campus kick! Youth will be served Frat house favorites with a spicy flavor.



BOB PRESCOTT presents

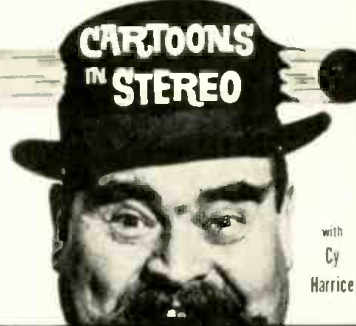

CARTOONS IN STEREO—DFS 7008  
CARTOONS IN SOUND—DFM 3008  
Bob Prescott, long-time peer of the professional sound effects men, gives his talents full expression in a mad variety of comical sound situations. Aided by the many voices of Cy Harrice.

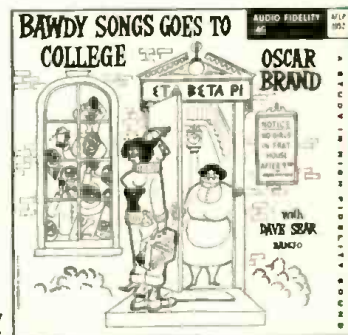

**BAWDY SONGS GOES TO COLLEGE**  
OSCAR BRAND  
ETA BETA PI  
WITH DAVE SEAR

AFLP 1952/AFSD 5952



**JEWISH AND ISRAELI FAVORITES**  
Johnny Puleo & his Harmonica Gang

Selections include: Hava Nagila, Tzena, Tzena, Bei Mir Bist Du Shein, Roszhinkes Mit Mandlen.

AFLP 1950/AFSD 5950



America's Greatest Trumpet Artist  
**AL HIRT SWINGIN' DIXIE**

Selections include: Milenberg Joys, Shine, Beale St. Blues, Deep River, Ain't Misbehavin', Moonglow.

AFLP 1927/AFSD 5927



**RIO**  
WITH LOVE  
Jo Basile, Accordion and Orchestra

Selections include: A Felicidade, Aquarela Do Brasil (Brazil), Bahia, Delicado, Apanheite Cavaquinho.

AFLP 1939/AFSD 5939



**MILITARY MARCHES**  
STADIUM ORGAN-CHICAGO  
AL MELGARD

Selections include: American Patrol, Columbia, The Gem of The Ocean & Dixie; Semper Fidelis; King Cotton;

AFLP 1908/AFSD 5908

SUGGESTED LIST PRICES: AFLP and DFM Series—\$4.98; AFSD and DFS Series—\$5.95  
For FREE catalogues of stereophonic and monaural LP albums and 2- or 4-track tapes: Dept. HF-4  
AUDIO FIDELITY INC. • 770 ELEVENTH AVENUE • NEW YORK 19, N. Y.  
CIRCLE 18 ON READER-SERVICE CARD

reviewed by

PAUL AFFELDER  
NATHAN BRODER  
O. B. BRUMMELL  
R. D. DARRELL  
ALFRED FRANKENSTEIN  
HARRIS GOLDSMITH  
JOHN F. INDCOX  
ROBERT C. MARSH  
CONRAD L. OSBORNE  
JOHN S. WILSON

## Records in Review



### The New *Tristan und Isolde*— Stereo . . . and So Much More

by Robert C. Marsh



*Culshaw, Nilsson, Uhl.*

**F**EW OPERAS have a more undisputed claim to eminence than Wagner's *Tristan und Isolde*, yet its recorded history is strangely at odds with its position in the world's great operatic theatres. Record makers have given us extracts of every description, but *Tristan* is really not a work that can be grasped adequately in abridgments. Nothing supplants the force of the whole.

The first substantial *Tristan* recording was a product of the 1928 Bayreuth Festival. Although it ran to twenty twelve-inch 78s, it was severely cut and thus severely inadequate. Still, it had the catalogue to itself (even receiving a transfer to LP) for two decades while the Metropolitan went through its glorious era in which Flagstad-Melchior and later Traubel-Melchior *Tristans* were directed by a series of distinguished conductors including Sir Thomas Beecham and Bruno Walter. Why one of these productions was never recorded remains a mystery, but the fact is that our only documentation of that period is a series of excerpts on old Victor and Columbia discs. Someday someone may piece together and provide such coherence as is possible, but the impression they produce on our later

generation can hardly be comparable to that of the national audience which heard the Metropolitan broadcasts of those years.

Our first complete *Tristan* had to wait for microgroove recording. It was a Leipzig production for Urania, and when it arrived one had mixed feelings of delight that it existed at all and dismay that it wasn't better. Happily, 1952 brought the Furtwängler-Flagstad version, now in print as Angel 3588 E/L, in which patience was finally rewarded with an uncut performance of exceptional musical stature. And that, up to now, has been the story of *Tristan* on records.

London's new set comes from Vienna sessions of last September. Its immediate interest might seem to lie in the fact that it provides the stereo debut of a work certain to flourish in the new medium, but the truth is that the distinctively stereoisitic elements of this recording are the least of the things which serve to make it memorable. *Tristan* does not provide the opportunities for special effects which London exploited in its earlier *Rheingold*. Stage action is limited even in the theatre. There are no rainbow bridges or caverns

resounding to the clank of anvils. True, conductor Georg Solti produces eighteen horns for the opening of the second act and a special wooden trumpet for the shepherd's joyful piping in Act III, but that's about the limit of it.

What gives real importance to this edition is simply that it is a phenomenally good performance of an exceptionally difficult opera. What makes review of it exacting is that its competition is a set sure to find a place among the great recordings of this century.

I would like to suggest, therefore, that we contrast the two versions, not on an either/or basis, but as two successful and representative productions from two different periods in operatic recording.

Perhaps the best illustration of the differing approaches is the different sonic perspective of the two versions. The Furtwängler is focused upon the singers, who dominate the orchestra when the engineers are obligated to choose between the instrumental or vocal line. The effect is unnatural, unless you are in the habit of listening to operas from the wings of the theatre; but for years we accepted it as a phonographic



*Eighteen horns for Act II.*

convention, because we knew that a monophonic recording could not contain all the orchestral detail, plus the singing, without saturation. The London album, on the other hand, seems the transfiguration of a performance in the theatre. The listener is very plainly seated at the brink of the orchestra pit, with the singers above and behind the players. If you are accustomed to hearing opera live, you will recognize at once where you are and, since the convention is observed consistently through the ten sides of the set, you will adjust yourself to this front row center position. Naturally, those who view opera through the conventions of recording will protest the prominence given the orchestra, which at some moments dominates the performance to the extent to making the singers inaudible. All one can answer is that with human voices it is impossible to produce *Tristan*, respecting Wagner's markings, and not drown out the singers from time to time. Thus I say the balances here are correct, although I suspect that there will be differences of opinion on this point.

Quite apart from differences in perspective between the '52 and '61 editions, there are differences in style. Furtwängler's *Tristan* is expansive and puts first emphasis on creating and sustaining a mood. Solti's basic pacing of the music is considerably faster; consequently—despite the fact that stereo discs cannot be filled as fully as the monophonic species—Solti gives us the complete score on the same number of surfaces as the Furtwängler set. Going from one performance to the other, the listener is struck by the depth of the atmospheric effect in the Furtwängler and the intensity and dramatic effectiveness of the Solti. I expect that for the majority of listeners the Solti point of view will be the more appealing, and certainly his is an extraordinary performance which could not be surpassed by any living conductor known to me.

Growing out of these basic differences in musical direction are the differences in singing. Kirsten Flagstad and Birgit Nilsson represent not merely two generations but two attitudes towards Wagner. Flagstad, for example, nearly al-

ways slips into the old-fashioned form of attack in which a phrase is begun about a quarter tone flat and eased up into the proper pitch. Nilsson hits her notes square and solid, and going from one to the other it is Nilsson who, in the end, has your admiration. I am not convinced, actually, that her voice, taken simply as a voice, is finer than Flagstad's, but we are hearing her at a much earlier phase of her career. To make a fair comparison of the two artists we would have to consider Flagstad material from the prewar period. Nilsson is really in superlatively good voice throughout this set. I heard her as Isolde in both Stockholm and Chicago, prior to her Metropolitan debut, and last season I attended one of her New York performances, shortly after she achieved national recognition. On none of these occasions did she sing as well as she does here, partly because the microphone does not require her to force a tone beyond the point at which her voice loses its best quality. I have the feeling, therefore, that in this album London has caught one of the supreme singers of our day at the very crest of her artistic maturity.

The *Tristan* of the new set is Fritz Uhl, a young tenor who is not likely to attempt the role very often in large theatres. His voice has the right quality but not the necessary size, although effective microphone placement provides him with the strength of tone needed to appear equal to Nilsson. Some will regret that Jon Vickers was not cast in this role, but few will deny that Uhl is superior to Ludwig Suthaus in the Furtwängler set. (Suthaus also belongs to an older tradition in which many Helden-tenors were, in fact, baritones with high notes.) Uhl's performance is well sung and intelligently conceived in terms of the musical and dramatic significance of his role. As the mad *Tristan* of Act III he rises to greater heights than anyone you are likely to hear on the stage. Again the microphone provides an advantage, since he can use his voice softly for dramatic effect without becoming inaudible.

The Furtwängler set is strongly cast with Blanche Thebom as Brangäne and Dietrich Fischer-Dieskau as Kurwenal. Their counterparts in the London album are Regina Resnik (who was, in fact, filling in at short notice for Grace Hoffman) and Thomas Krause. Neither surpasses the older version's counterparts. Resnik suffers from a rapid vibrato a fair amount of the time, and I find her work in the role no more than adequate. Krause provides a well-developed characterization that is more traditional than Fischer-Dieskau's (as well as livelier). Arnold van Mill is the Marke here and he gets us through his complete sermon without dismay, which is all one can ask from anyone in the role. Ernst Kozub, Peter Klein, and Theodor Kirschbichler meet all reasonable expectations as Melot, the shepherd, and the steersman respectively, and Waldemar Kment provides two

lovely moments as the sailor singing in the rigging about his Irish maid.

What you hear of the chorus is good. The orchestra is glorious beyond all expectation, and obviously it feels the proper style of this music more deeply than Furtwängler's English players.

It would be premature, I think, to say that this is a *Tristan* of 1960 that reflects our approach to Wagner as effectively as the Furtwängler-Flagstad version preserves that of an earlier period, but I suspect that this judgment will be reached. Certainly for those who place first emphasis on sonic quality and theatrical realism, there is no rivalry between these editions.

Yet all these things apart, there is a further consideration forced on me by the accumulated experiences of a week of close listening to this music. *Tristan* is really too large for the theatre. It almost always must be cut, simply to keep the physical demands on the singers within human proportions, and yet the cuts always remove something that is worthy of being heard. (The score I used came from Artur Rodzinski and showed his editing of the cuts used at the Metropolitan by Toscanini.) I was always delighted to hear the cuts I knew in the operatic version restored, for often in the restored text there was an introduction of a motif, a symbolic reference in the text, or some other thing that makes *Tristan* the masterpiece it is, which I had previously neglected.

I am coming to think that the proper way to hear this work is one Wagner never imagined: at home, score or libretto in hand, one act per evening. *Tristan* repays concentrated study of this type, and I believe London really had something of the sort in mind when it made this set. John Culshaw, who directed the sessions, has written that what he wanted was to record *Tristan* "as the composer might have imagined it." The record of excerpts from the rehearsals and control room conferences which comes as a bonus with the album will show better than anything I can say how artists and engineers worked to achieve that end. The backstage glimpses are entertaining and surely will provide a pleasant feeling of involvement in the proceedings, but the real test is what happens to the listener. It is my conclusion that these records may give him an awareness of the grandeur of Wagner's achievement such as he never possessed before.

#### WAGNER: *Tristan und Isolde*

Birgit Nilsson (s), Isolde; Regina Resnik (ms), Brangäne; Fritz Uhl (t), *Tristan*; Ernst Kozub (t), Melot; Waldemar Kmentt (t), Young sailor; Peter Klein (t), Shepherd; Thomas Krause (b), Kurwenal; Arnold van Mill (bs), King Marke; Theodor Kirschbichler (bs), Steersman. Singverein der Gesellschaft der Musikfreunde; Vienna Philharmonic Orchestra, Georg Solti, cond.  
 • LONDON A 4506. Five LP. \$23.90.  
 • • LONDON OSA 1502. Five SD. \$28.90.

**"Mercury is consistently producing the best sounding opera to be found today"**  
**—Roger Dettmer**  
**Chicago American**



**VERDI** Rigoletto, or "La Maledizione." Ettore Bastianini in the title rôle, Renata Scotto as Gilda, Alfredo Kraus as the Duke. Supporting cast, orchestra and chorus from the Maggio Musicale Fiorentino, all under the direction of Gianandrea Gavazzeni. Recorded at the Teatro della Pergola, Florence; sung in Italian. Three discs. Notes and synopsis by Herbert Weinstock. Cover drawings by Eugene Berman, especially for this album. (New Release)  
 SR3-9012 (stereo) / OL3-112 (mono)

**ROSSINI** La Cimbale di Matrimonio. Renata Scotto, Nicola Monti, Rolando Panerai, Renato Capecchi, and others, with I Virtuosi di Roma conducted by Renato Fasano. This is the only complete recording of Rossini's first opera. He was obviously so pleased with the work that he used melodic portions of it in the later Barber of Seville. Two discs, sung in Italian. Recorded at Il Teatro Grande in Brescia. Notes and synopsis by Herbert Weinstock. Silhouette drawings by the celebrated Danish artist Bjorn Wiinblad. (New Release)  
 SR2-9009 (stereo) / OL2-109 (mono)

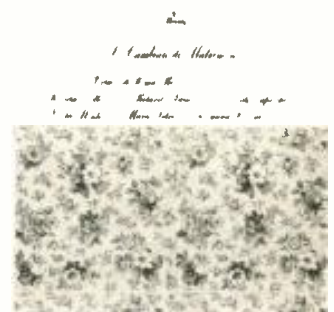

**DONIZETTI** Lucia di Lammermoor. Renata Scotto as Lucia, Giuseppe di Stefano as Edgardo, Ettore Bastianini as Enrico, and other soloists, with the chorus and orchestra of La Scala, conducted by Nino Sanzogno. "It is very, very seldom that one hears drama such as this on records or in the opera house. . . This is the recorded performance of Lucia di Lammermoor and should be in every collection of opera worthy of the name."  
 —THE NEW RECORDS  
 SR2-9008 (stereo) / OL2-108 (mono)

**PAISIELLO** The Barber of Seville. Graziella Scutti, Nicola Monti, Rolando Panerai, Renato Capecchi, and others. The orchestra is I Virtuosi di Roma, conducted by Renato Fasano. "A gay, quicksilver score, some limpidly graceful airs, and several scenes of truly inspired buffoonery. Soprano Scutti, fresh-voiced and fanciful, makes Rosina seem one of the most appealing heroines in opera."  
 —TIME  
 SR2-9010 (stereo) / OL2-110 (mono)



**CHERUBINI** Medea. Maria Callas in her self-admitted finest rôle, with Renata Scotto, Mirto Picchi, Giuseppe Modesti, and other soloists. Orchestra and chorus of La Scala in Milan, where the opera was recorded, under the direction of the "dean of operatic conductors," Tullio Serafin. "The most beautiful vocal recording today is that of the opera 'Medea' on Mercury."  
 —THE GRAMOPHONE  
 SR3-9000 (stereo) / OL3-104 (mono)

**PERGOLESI** La Serva Padrona. The miniature comic masterpiece involving a brazen chambermaid and her gullible employer. Renata Scotto and Sesto Bruscantini are the whole cast (the third character is heard from only by foot-stamping and giggles). Renato Fasano and I Virtuosi di Roma accompany. Complete on one disc with full libretto. "Untiringly fresh and gay. Mercury's cast gives the classic Pergolesi farce a fine performance."  
 —THE SAN FRANCISCO EXAMINER  
 SR90240 (stereo) / MG50240 (mono)



**ONLY ON MERCURY**  
**FIRST—THE 1812 OVERTURE WITH REAL CANNON AND BELLS—**  
**NOW AND NEW—THE ONLY WELLINGTON'S VICTORY**  
**UTILIZING THE COMPLETE FORCES IN BEETHOVEN'S ORIGINAL SCORE**









MERCURY RECORD CORPORATION  
 745 FIFTH AVENUE, NEW YORK 22, N. Y.



CIRCLE 81 ON READER-SERVICE CARD

**FEATURING :**

-  THREE ORCHESTRAS PLUS AUGMENTED BRASS AND PERCUSSION
-  FRENCH CHARLEVILLE-PATTERN MUSKETS
-  BRITISH BROWN BESS MUSKETS
-  6-POUND FRENCH CANNON MADE IN 1761
-  6-POUND BRITISH CANNON MADE IN 1755
-  12-POUND 18TH CENTURY HOWITZER
-  188 CANNON SHOTS AND 25 MUSKET VOLLEYS SYNCHRONIZED PRECISELY WITH THE MUSIC

## CLASSICAL

### BACH: *Brandenburg Concertos* (complete)

Stuttgart Chamber Orchestra, Karl Münchinger, cond.

• RICHMOND BA 42002. Two LP. \$3.96.

For almost a decade from the time when it was first released in this country in 1950, this set was regarded as one of the two or three best complete *Brandenburgs* on microgroove. From the standpoint of performance it still deserves a high place among available sets, being superior in that respect to the recent London recording by the same forces. The string sound now seems somewhat edgy, and approaches reality on my equipment only when the treble control is turned pretty far down. There are now several excellent and well-recorded performances in the catalogue, including some in stereo; but if you are looking for a bargain in *Brandenburgs*, or if you don't have to have the hi-est of fi, this set is recommended. N.B.

### BACH: *Cantata No. 58, Ach Gott, wie manches Herzeleid; Arias from Cantatas Nos. 114, 182, 202, and Mass in F, S. 233*

Soloists: Bach Aria Group Orchestra, Frank Brieff, cond.

• DECCA DL 9411. LP. \$4.98.

• • DECCA DL 79411. SD. \$5.98.

Cantata 58, recorded here complete, is new to microgroove. It is a dialogue for soprano and bass, consisting of five numbers: two duets, a recitative for each soloist, and an aria for soprano. Not one of the great cantatas, it nevertheless contains much of interest. Eileen Farrell, the soprano, is in fairly good form here, and Miss Farrell in fairly good form is head and shoulders above most sopranos to be heard in recordings of Bach cantatas. Norman Farrow, the bass, is a sturdy partner, and manages even the difficult low part in the second duet with considerable accuracy.

The individual arias comprise two for tenor (from Cantatas 114 and 182), two for alto (from Cantata 33 and the "Quoniam" from the Mass), and one for soprano (from Cantata 202). Jan Peerce, the tenor, as usual gives his all. There is a special piquancy in this robust Italian style of singing applied to Bach; it is much to be preferred, it seems to me, to the detached, monochromatic singing, moving on one dynamic plane, that is sometimes heard in this music. Carol Smith, the alto, handles her agreeable dark-colored voice with much skill in the difficult arias from the Mass and negotiates the unusual melodic convolutions of the other aria with musicality and feeling. I must mention, too, the meltingly beautiful oboe playing of Robert Bloom in the aria from 202. Excellent sound in both versions. N.B.

### BACH: *Concertos: for Two Violins and Orchestra, in D minor, S. 1043; for Violin and Orchestra, in E, S. 1042*

Leonid Kogan, violin (in S. 1043 and S. 1042); Elizaveta Gilels, violin (in S. 1042); Moscow Chamber Orchestra, Rudolf Barshai, cond.

• MK-ARTIA 1518. LP. \$4.98.

The same pair of works, recorded by the same pair of artists with a different orchestra, has been available for several years on an Angel disc. Here, as in the other version, Kogan and his wife (who is Emil Gilels' sister) turn in an excellent performance, clean and so intelligent musically that one is never left in any doubt about which of the two solo lines is leading, even when leadership passes quickly back and forth between them. The solo concerto is also very nicely played. In the Angel there was no continuo at all. Here the harpsichord is usually inaudible, and on the rare occasions when it can be heard, sounds as if it were being played several versts away. This Russian-made disc has a slight surface noise, but otherwise its sound compares favorably with that of Western recording. N.B.

### BADINGS: *Capriccio for Violin and Two Sound Tracks; Genèse; Evolutions*

†Raaijmakers: *Contrasts*

Joke Vermeulen, violin.

• Epic LC 3759. LP. \$4.98.

• • Epic BC 1118. SD. \$5.98.

Henk Badings is a composer of unique distinction: he makes pretty music by electronic means. The best of the three works by him on this disc is the *Capriccio*. To all intents and purposes a short concerto for violin and tape, and an extremely good one, this work makes highly dramatic and expressive use of the contrast between the violin's fixed pitch and the indefinite pitches of the tape, the violin's single flamboyant or lyrical line and the tape's multispatial resonances, the violin's singing, familiar tone color and the tape's kaleidoscopic palette of new timbres and textures. Part of the effectiveness of the piece, as recorded, lies in Vermeulen's superb violin playing.

*Genèse* is also a very good work. It is a suite in three movements for five audio-frequency oscillators exploiting, above all, the light, chirping, gurgling, and scintillating tones in the electronic spectrum. A ballet called *The Sixth Day* has been set to this sunny piece, but it sounds more like what happened on the fourth day of Genesis than the sixth.

Badings' third composition on this release is just *too* pretty. Even though, as we are told in the notes, "the entire apparatus of Philips' physical laboratory at Eindhoven was used in the composition of *Evolutions*," one has an uneasy feeling that if this music were somehow transcribed for normal orchestra, what would come out would sound exactly like *In a Persian Market* or some such trivia.

Dick Raaijmakers seems to be a technical consultant in the Philips laboratory. His *Contrasts* is a short, lively affair that serves well to fill out a side and keep it interesting.

The recording is of top quality, but of the two versions the stereo is much to be preferred, since both composers rely heavily upon aural relief and the ping-pong effect. The stereo is also the more successful of the two versions—at least

## NEXT MONTH IN

# high fidelity

### Four Russians Called Budapest

An extraordinary musical democracy produces some of the world's most admired chamber music.

by Philip Hart

### Prokofiev on the Patio

Summertime stereo is as practical at poolside as in the sitting-room.

by Norman Eisenberg

### Donizetti—Composer on the Rebound

A new generation is rediscovering significance in some of the seventy-odd operas by the composer of "Lucia."

by Patrick Cairns Hughes

### Noise, the Uninvited Guest

The audiophile needn't take the presence of extramusical noises lying down.

by Donald C. Hoefler

Continued on page 94

# INCOMPARABLE

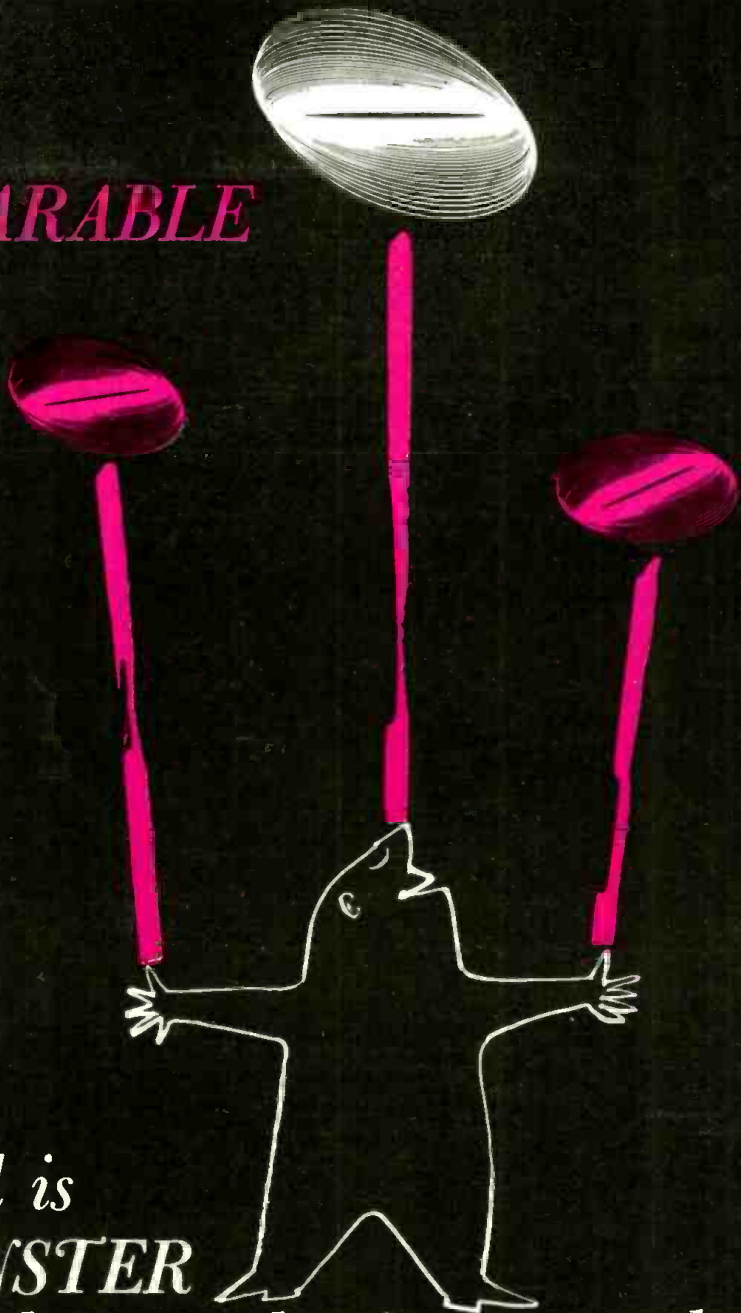

*When the record is  
WESTMINSTER  
you hear more, because there's more to hear!*

**IVOR NOVELLO'S MUSIC HALL.** "CREST OF THE WAVE": Rose of England. "PERCHANCE TO DREAM": Love is My Reason — We'll Gather Lilacs. "KING'S RHAPSODY": Take Your Girl — Someday My Heart Will Awake — Fly Home Little Heart. "THE DANCING YEARS": Leap Year Waltz — My Dearest Dear — Waltz of My Heart. "GLAMOROUS NIGHT": Fold Your Wings — Shine Through My Dreams — Glamorous Night. Eric Johnson and His Orchestra. WST 14134  
XWN 18953

**HERMANN SCHERCHEN CONDUCTS CONCERTOS FOR TRUMPET.** HAYDN: Concertos for One Trumpet and Orchestra in E Flat Major. TORELLI: Concerto for One Trumpet and Orchestra in D Major. VIVALDI: Concerto for Two Trumpets and Orchestra in C Major. HANDEL: Concerto for Two Trumpets and Orchestra in D Major. Vienna State Opera Orchestra, Hermann Scherchen, Conductor. Roger Delmotte, 1st Trumpet. WST 14135  
XWN 18954

**INTRODUCING FOU TS'ONG PLAYING MOZART.** Concerto for Piano and Orchestra in C Major (K.503); Concerto for Piano and Orchestra in B Flat Major (K.595). Vienna State Opera Orchestra, Victor Desarzens, Conductor. Fou Ts'ong, Piano. WST 14136  
XWN 18955

**INTRODUCING FOU TS'ONG PLAYING CHOPIN.** Ballad No. 1 - Opus 23 in G Minor; Ballad No. 2 - Opus 38 in F Major; Ballad No. 3 - Opus 47 in E Flat Major; Ballad No. 4 - Opus 52 in F Minor; Prelude No. 26 in A Flat Major; Prelude Opus 45 in C Sharp Minor; Berceuse Opus 57 in D Flat Major. Fou Ts'ong, Piano. WST 14137  
XWN 18956

**LOLLYPOPS FOR BIG BRASS BAND.** Tritsch-Tratsch Polka (Johann Strauss, Jr.); Wien, Wien nur du allein (J. Siczinsky); Dixie (E. Emmitt); In a Persian Market (A. Ketelby); Military March (F. Schubert); Can, Can (J. Offenbach); Gaudeamus igitur (traditional); Husarengalopp

(F. Zelwecker); Draussen in Sievering (G. Stolz); Hallelujah Chorus from "Messiah" (G. F. Handel). The Deutschmeister Band, Julius Hermann, Conductor. WP 6124 WST 15058

**SCOTCH AND SODA, PLEASE.** Marabelle; Nina's Lullaby; Manhattan Interlude; Doris' Dream; Portrait Of Ray; La Valse d'Aplyne; Mazurka From Manhattan; Mother's Lullaby; Souvenir For Ida; A Prelude To Four Sisters; Silent Is Her Heart; My Favorite Star (Is Still In Texas). Ray Cassarino, Pianist. WST 15066  
WP 6132

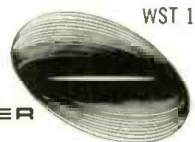

**WESTMINSTER**

Collectors: Send for your Complete Westminster Catalogue. Write: Westminster Recording Co., Dept. HF 461, 74 Alabama Avenue, Island Park, New York.

in my living room—at arousing sympathetic vibrations in cabinets, lampshades, and such loose glassware as may be lying around, thereby adding numerous exhilarating and unexpected sounds to the symphony. A.F.

**BEETHOVEN:** *Concerto for Piano and Orchestra, No. 5, in E flat, Op. 73 ("Emperor")*

Claudio Arrau, piano; Philharmonia Orchestra, Alceo Galliera, cond.

- ANGEL 35722. LP. \$4.98.
- • ANGEL S 35722. SD. \$5.98.

With this release there are ten stereo *Emperors* in the catalogue, and not a single one of them is good enough to dominate the field. The present set is

wildly unbalanced in the two-channel version, rather as if the piano had been placed on the far right side of the stage and the violins were huddled in the left rear. (This effect is not the result of any flaw in my equipment; I checked that out to be sure.)

If you have quite a bit of leeway in your balance controls and have a quiet record you can remedy these flaws reasonably well, discovering—as the well-engineered mono sets will tell you without this fuss—that this performance finds Arrau in excellent form and more than able to prove himself among the finest pianists of the day. Galliera, as in the earlier discs in this series, proves an accompanist well suited in both musicianship and temperament to support the big, solid performances Arrau contributes to their collaboration. Some of

Arrau's passagework here has an authority and substance only an exceptional artist can provide—and no other recent recording can surpass.

But that stereo master needs fixing. R.C.M.

**BEETHOVEN:** *Sextet for Two Horns and Strings, Op. 81b*—See Mozart: *Twelve Duos for Horns, K. 487.*

**BEETHOVEN:** *Sonata for Cello and Piano, No. 3, in A, Op. 69*—See Prokofiev: *Sonata for Cello and Piano, in C, Op. 119.*

**BEETHOVEN:** *Symphony No. 3, in E flat, Op. 55 ("Eroica")*

Philharmonia Orchestra, Otto Klemperer, cond.

- ANGEL 35853. LP. \$4.98.
- • ANGEL S 35853. SD. \$5.98.

When the earlier Klemperer edition of this score appeared in the 1956-57 season, C. G. Burke, writing in this journal, called it "the best of the Heroic Symphonies going slowly." The description still applies.

Anyone conversant with the physical and psychological processes involved in music making will take it as a matter of course that the two performances are different. The new edition tends to be a little slower than its predecessor, although there are some passages in which it's faster—and to good effect. I trust that Angel will have the wisdom to keep the earlier set, 35328, in the catalogue, since serious students of Beethoven will want both. The principal difference is the sound, of course, which here has a strength in the climactic pages one cannot muster from the old disc. Unfortunately stereo grooving demands that the second movement be divided across sides. The break selected is, happily, a natural halting point. R.C.M.

**BEETHOVEN:** *Symphony No. 7, in A, Op. 92; Egmont Overture*

Berlin Philharmonic Orchestra, Joseph Keilberth, cond.

- TELEFUNKEN TC 8040. LP. \$1.98.
- • TELEFUNKEN TCS 18040. SD. \$2.98.

From the frequency with which it is recorded, heard in concert, and played on the air, I would surmise that the Seventh has supplanted the Fifth as the most popular of the monumental nine. Choices of this sort between genuine masterpieces are always difficult, but I have come to the conclusion that the Seventh is the finer score.

One thing is certain: with nearly thirty versions of the work in Schwann, there is no shortage of good recordings. Until now, however, we have lacked a solidly up-to-date version on a low-priced label. Telefunken has fully met the need. Both in mono and stereo this disc is competitive with most editions in the usual price range. The performance is forthright and transmits its energy to the listener, yet the music is played for the sake of Beethoven rather than as a vehicle for the conductor or orchestra. The mono sound is richly colored and firmly textured—an excellent likeness of a German orchestra of

*Continued on page 96*

HIGH FIDELITY MAGAZINE

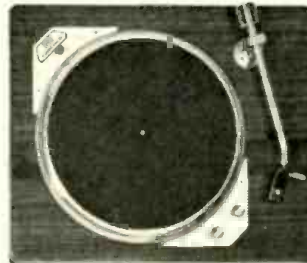

# FAIRCHILD

SUPERIOR IN DESIGN, IN EXECUTION, IN PERFORMANCE

# COMPONENTS

FAIRCHILD RECORDING EQUIPMENT CORP., 10-40 45TH AVE., LONG ISLAND CITY, N. Y.

# ARE SUPERIOR!



◀ **MODEL 412-1.** Single Speed Turntable (\$87.50). Model 500 Arm Transport and SM-2 Cartridge (\$55.00). Mounted on Model 412-BF Walnut and Formica Base (\$23.95).

▶ **MODEL 440.** Two Speed Turntable\* (\$69.95). Model 500 Arm-Transport and SM-2 Cartridge (\$55.00). Mounted on Model 440CBW Walnut Base (\$19.95).



\*Available in Kit Form—\$55.

## MORE EXCITING NEWS!!!!

Fairchild announces with pride the availability of the SM-2 Linear Separation Stereo Cartridge. This is important news for those who appreciate fine audio equipment for the introduction of a new Fairchild cartridge is not merely "just another" new item, but a product development that reflects advanced concepts and design.

The SM-2 is a significant step forward to achieve the complete realization of the stereo records capabilities. We sincerely urge you to carefully audition this fine, new development . . . the SM-2 by Fairchild . . . \$37.50

**MAJOR FEATURES INCLUDE**—high compliance (5 x 10<sup>-4</sup> cm/dyne) without stylus assembly fatigue for perfect tracking; Linear Separation of 20 db from 20 to 15,000 cps for recreation of the original studio concept; smooth frequency response (±2 db from 20 to 15,000 cps) for truthful reproduction of the full audio spectrum.

CIRCLE 47 ON READER-SERVICE CARD



# RCA VICTOR *brings you the world's greatest artists on fabulous new* 4-TRACK REEL TAPES



FTO-6002

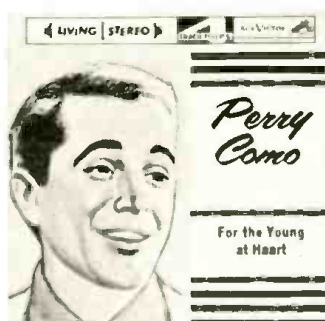

FTP-1071

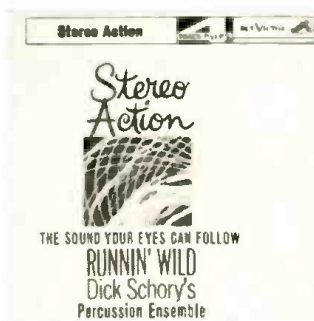

FTP-1063



FTP-1066

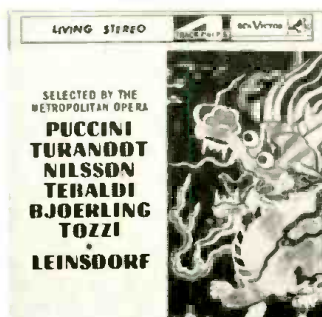

FTC-8001



FTC-2055

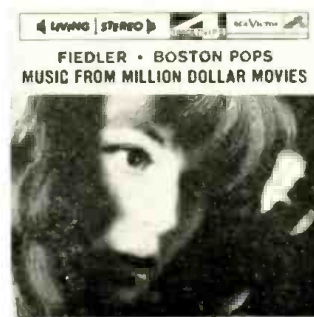

FTC-2023

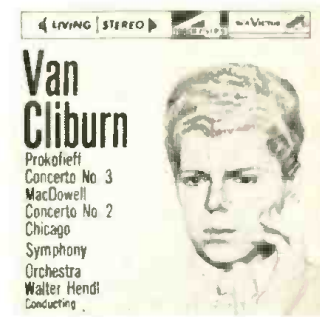

FTC-2060

## POP

- FTO-5004/Wildcat - Original Cast
- FTO-5007/Exodus - Original Sound Track
- FTP-1067/Dancing on a Cloud - Three Suns
- FTP-1037/The Blues and the Beat - Henry Mancini
- FTP-1055/Dynamica - Ray Martin (Stereo Action)

## RED SEAL

- FTC-7000/Requiem (Berlioz) - Munch, Boston Sym.
- FTC-2021/Rossini Overtures - Reiner, Chicago Sym.
- FTC-8000/Il Trovatore (Verdi) - Price, Tucker, Warren, Others
- FTC-2058/Rhapsodies, The Moldau, etc. - Stokowski
- FTC-2011/Con. in D Mi. (Sibelius) - Heifetz; Hendl, Chi. Sym.

**RCA VICTOR**  
TRADE MARK RADIO CORPORATION OF AMERICA

ASK YOUR DEALER ABOUT THE COMPACT 33. NEWEST IDEA IN RECORDS

CIRCLE 92 ON READER-SERVICE CARD

first rank. Stereo spreads the source, puts an occasional sharp edge on the strings, and adds some clarity, but it is not as good an example of two-channel engineering as the mono is in its genre. Either set rates as a best buy, however. R.C.M.

**BERLIOZ: Overtures**

*Le Carnaval romain, Op. 9; Béatrice et Benedict: Le Corsaire, Op. 21; Benvenuto Cellini, Op. 23; Les Troyens à Carthage: Royal Hunt and Storm.*

Boston Symphony Orchestra, Charles Munch, cond.  
 • RCA VICTOR LM 2438. LP. \$4.98.  
 • • RCA VICTOR LSC 2438. SD. \$5.98.

A welcome addition to Munch's already impressive list of Berlioz interpretations,

these readings are marked by tension and fiery excitement, with the Boston Symphony playing at its best. And for contrast to the extroverted overtures, the disc also offers the *Royal Hunt and Storm*, the famous instrumental interlude from the second part of *Les Troyens*, presented with exceptional sensitivity and refinement.

Unfortunately, Victor's engineers have not risen to the occasion. Over-all balance and sound on the first side are completely satisfactory, with stereo imparting the expected added dimension. But Side 2 appears to have been recorded on a different date and under different conditions. Here, the orchestra seems to be spread over a large area, with microphones placed haphazardly. The lower strings remain in fairly sharp focus, as does the percussion; but the violins and brasses, in particular, are lacking in

presence. These deficiencies may be heard in both the one- and two-channel editions. Despite these sonic shortcomings, however, this is a disc worth adding to any Berlioz collection. P.A.

**BIZET: L'Arlésienne: Suites: No. 1; No. 2**

Orchestre de Société de Concert de Vienne, Pierre Kaufmann, cond.  
 • ROULETTE R 75005. LP. \$4.98.  
 • • ROULETTE SR 75005. SD. \$5.98.

Here are good, solid, straightforward readings of these two popular suites, well paced except for a moderately sluggish *Carillon* in the Suite No. 1. And while Roulette's "nom-de-disque" for its Viennese orchestra is rather strange, that orchestra's playing is first-rate—as is the clear, faithful reproduction, well separated in stereo. P.A.

**BIZET: Symphony in C  
 †Lalo: Symphony in G minor**

Orchestre National de la Radiodiffusion Française, Sir Thomas Beecham, cond.  
 • EMI-CAPITOL G 7237. LP. \$4.98.  
 • • EMI-CAPITOL SG 7237. SD. \$5.98.

Bizet's sprightly Symphony is ideally suited to the late conductor's interpretative style, and it naturally follows that his account of it here is immaculate and perfectly proportioned.

The unfamiliar Lalo Symphony (which once—Capitol's jacket notes notwithstanding—existed on a Urania LP) perhaps is not the composer's best creation, but it is well organized, with a motto running through three of its four movements that is a minor-mode version of the opening theme of Brahms's Piano Concerto No. 2, in B flat, a work which appeared in 1881, shortly before the present symphony was begun. There are also occasional reminiscences of Lalo's own Cello Concerto. Again, Sir Thomas turns in a performance that is incisive, warm, and perceptive. Capitol's stereo recording is wide-range and well separated, and all told this disc belongs in every Beecham collection. P.A.

**BRAHMS: Concerto for Piano and Orchestra, No. 2, in B flat, Op. 83**

Julius Katchen, piano; London Symphony Orchestra, Janos Ferencsik, cond.  
 • LONDON CM 9264. LP. \$4.98.  
 • • LONDON CS 6190. SD. \$5.98.

Katchen and Ferencsik take a lyrical, unruffled attitude towards this work and for the most part, they are successful in conveying its broad poetry. Sometimes, however, the pianist is inclined to blur the phrase outlines by overuse of the pedal, and a slight feeling of strain imparts a tentative tone to much of his otherwise musically playing on this disc. The sound is very realistic, but somewhat distant, and this may be partly responsible for the impression I have of a lack of true weight and power in this rendition.

All told, this is one of the better Brahms B flats now available, but the most recent Serkin-Ormandy version for Columbia, despite a few labored passages, presents a musical experience that I find more grippingly profound. H.G.

*Continued on page 98*

a  
great  
name



**ARTIA**

a  
greater  
sound

**ARTIA**

the  
greatest  
artists

**ARTIA**

**SVIATOSLAV RICHTER • DAVID OISTRAKH • EMIL GILELS  
 DIMITRI BASHKIROV • DANIEL POLLACK • VACLAV TALICH  
 PRAGUE NATIONAL THEATER • CZECH PHILHARMONIC  
 KONSTANTIN IVANOV • KAREL ANCERL • IGOR OISTRAKH  
 KIRIL KONDRASHIN • BOLSHOI THEATER • LEONID KOGAN  
 MSTISLAV ROSTROPOVICH • LENINGRAD PHILHARMONIC  
 EUGENE MRVINSKY • ZARA DOLUKHANOVA • KAREL  
 SEJNA • VLADIMIR ASHKENAZY • GALINA VISHNEVSKAYA  
**ARTIA • PARLIAMENT • MK • SUPRAPHON****

ARTIA RECORDING CORP. • 38 WEST 48th STREET, NEW YORK 36, NEW YORK  
 CIRCLE 11 ON READER-SERVICE CARD

# NEW \* \* FROM LIBERTY, THE PREMIER SERIES

SPECTACULAR IN PERFORMANCE AND LISTENING PLEASURE



When you hear their quality of performance and sound, you'll know why we say these exceptional works of album artistry surpass anything on today's market! \* \* You are cordially invited to listen to a specially recorded Premier demonstration with selections from each of the albums... now at record stores everywhere. \* \* \* \* \*



**PORTRAITS IN BRONZE** Bessie Griffin & the Gospel Pearls LMM-13002/LSS-14002 An almost unbelievable voice surging with powerful emotion against a chorus of wild, handclapping jazz. Hear: I Believe, Bye and Bye, Lord Don't Move The Mountain, Sometimes I Feel Like A Motherless Child, 8 other spirituals.



**THE MAGIC BEAT** The Unique Rhythms of Richard Marino LMM-13003/LSS-14003 The thrill and beat of an excitingly different musical sound, presented by one of the nation's leading arranger-conductors. Listen to: Fever, Seventy-six Trombones, Poor People of Paris, Colonel Bogey, High Noon, Lover, and 6 others.



**THE MAGNIFICENT XII** The Fantastic Strings of Felix Slatkin LMM-13004/LSS-14004 Memorable motion picture themes and instrumental favorites in rich, lavish sound. Hear: Exodus, Song From Moulin Rouge, Never on Sunday, Sun-downer's Theme, Laura, Unchained Melody, 6 more.



**PARADISE FOUND** The Fantastic Strings of Felix Slatkin LMM-13001/LSS-14001 A native Hawaiian ensemble blended with sweeping string backgrounds. Exciting! Hear: Moon of Manakooa, Beyond the Reef, Sweet Leilani, Hawaiian Wedding Song, Aloha Oe, Little Grass Shack, 6 others.

write for complete catalog...LIBERTY RECORDS, DEPT. H-4 HOLLYWOOD, CALIFORNIA

# THE CHORUS



## THE MAN:

Roger Wagner, America's top choral director, who has brought a breathtaking perfection of style to choral art the world over.

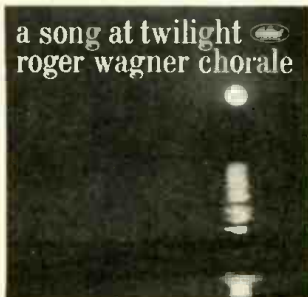

## THE MOOD:

Nostalgic and serene as the richly mixed voices of the Roger Wagner Chorale recapture the peaceful years with melodies like "The Last Rose of Summer," "Love's Old Sweet Song," "In the Gloaming," and other old favorites. (S) P8543

**BRAHMS:** *Symphony No. 1, in G minor, Op. 68*

New York Philharmonic, Leonard Bernstein, cond.

- COLUMBIA ML 5602. LP. \$4.98.
- • COLUMBIA MS 6202. SD. \$5.98.

Bernstein presents a fairly extroverted interpretation of this noble symphony. The first movement has a great deal of vigor and forward motion; the second is quite expressive; the third rather leisurely, while the variations of tempo in the finale make it sound a bit episodic, especially in the exaggerated handling of the coda. Taken as a whole, however, it is a more than acceptable performance, highlighted by some brilliant work from the Philharmonic's musicians and fine sound from Columbia's engineers. Klemperer, Kubelik, and Walter offer more thoughtful readings. P.A.

**BRUCH:** *Concerto for Violin and Orchestra, No. 1, in G minor, Op. 26*

†Mendelssohn: *Concerto for Violin and Orchestra, in E minor, Op. 64*

Nathan Milstein, violin; Philharmonia Orchestra, Leon Barzin, cond.

- CAPITOL P 8518. LP. \$4.98.
- • CAPITOL SP 8518. SD. \$5.98.

This is the third time that Milstein has recorded these two concertos, and each time the results have been nothing short of magnificent. It is advances in the science of recording, of course, that explains redoing this music. Actually, there is nothing wrong with Capitol's 1954 recording, in which Milstein was accompanied by William Steinberg and the Pittsburgh Symphony Orchestra. No one who owns it need replace it. Although the new edition has the advantage of stereo, the balance between soloist and orchestra was more equitable on the older disc. In the present version, the violin stands out in bolder relief against the orchestra, which is sometimes kept too far in the background. The over-all tone quality, however, is most faithful, and there is excellent presence in the sound of the solo violin.

The performances themselves could hardly be better. Milstein is satisfied to let the music speak for itself, and it seems fairly to flow from his bow. Barzin's accompaniments are discreet and well disciplined, providing just the right support. A more rewarding violin concerto disc would be hard to find. P.A.

**CASELLA:** *Paganiniana*—See Rachmaninoff: *Symphonic Dances, Op. 45*.

**CHOPIN:** *Ballades: No. 1, in G minor, Op. 23; No. 2, in F, Op. 38; No. 3, in A flat, Op. 47; No. 4, in F minor, Op. 52*

†Liszt: *Chants polonais (6)*

Ruth Slenczynska, piano.

- DECCA DL 10029. LP. \$4.98.
- • DECCA DL 710029. SD. \$5.98.

Not only do the self-conscious, angular phrasing and fussy changes of basic tempo in these performances impede the natural flow of the music, but the pian-

# THE ORCHESTRA



## THE MAN:

Erich Leinsdorf, "the consummate musician" whose vitality and precision are known throughout the musical world.



## THE MOOD:

Vibrant and exciting as Leinsdorf conducts the Concert Arts Orchestra in the most dazzling performance this Oriental tour-de-force has ever had. Spectacular in sound, too! (S) P8538

# THE SOLOIST



## THE MAN:

Virgil Fox, reigning monarch of 'the king of instruments' and one of the world's most popular concert organists.



## THE MOOD:

Dramatic and expansive. Fox pays tribute to the great organ music of France as he performs masterful works by Franck, Duruflé, Vierne and Dupré. (S) P8544



CIRCLE 31 ON READER-SERVICE CARD

Continued on page 100



...choice  
of the  
talented  
listener

Before each piano performance in Hollywood Bowl it is Jim Bryans' responsibility to tune and voice the magnificent instrument played by the world's great virtuosos. Success depends on the sensitivity of his ears and the skill of his hands. Mr. Bryans selected a JBL theater speaker system for home listening because "it duplicates the sound of a piano — any other instrument or the human voice, for that matter — more perfectly. A piano tone is a fragile thing. Many lifetimes have gone into its development. It is a miracle to me, and I'm sure a blessing to many critical listeners, that JBL provides the means to reproduce this exquisite sound so faithfully in the home. What will I do to improve my system? I'm not sure there is anything I can do. I don't feel the need for improvement. If you don't make a better speaker, who does?"

*Hear Jim Bryans' choice in the demonstration room of the Authorized JBL Signature Audio Specialist in your community. Write for his name and your free copy of the complete JBL catalog.*

JAMES B. LANSING SOUND, INC., Los Angeles 39, California

# WHAT'S NEW WON ANGEI?



**Franco Corelli**  
**I Pagliacci**  
conducted by  
**LOVRO VON MATAČIĆ**  
Chorus Master: Norberto Mola

Starring Franco Corelli, the sensational young Italian tenor making his first U.S. appearances at the Met this season.  
Also starring Lucine Amara, soprano and Tito Gobbi, baritone.  
La Scala Orchestra and Chorus, Lovro von Matačić, Conductor.  
(S) 3618 B/L

OPERATICALLY NEW!!!

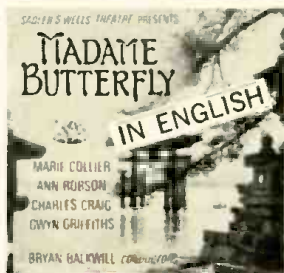

The only recording in English of highlights from an opera favorite.  
A Sadler's Wells production starring Marie Collier, Ann Robson, Charles Craig and Gwyn Griffiths. Sadler's Wells Orchestra. Bryan Balkwill, Conductor.  
(S) 35902

ist's sense of timing is lax. In the *sotto voce* beginning of the F major Ballade, for example, the rushed, nerveless *allegretto*, as opposed to the indicated *andantino*, is chiefly the result of careless accentuation of rhythm. And at measure 88 (again at measure 201) in the same piece, the pianist destroys the composer's "interrupted serenade" effect by imprecise counting of note values. Admittedly, these are extreme examples, but this sort of unincisive musical thinking is on evidence throughout the disc. Furthermore, the piano tone is dull and glassy, an effect which must surely be due partly to the particular instrument itself. The stereo version has a blasty distortion and shallow congestion: the LP is better. H.C.

**CIMAROSA: Il Maestro di Cappella**  
†Mozart: *Concert Arias; Per questa bella mano, K. 612; Rivolgete a lui lo sguardo, K. 584; Aspri rimorsi atroci, K. 432; Non so donde viene, K. 512; Un bacio di mano, K. 541; Mentre ti lascio o figlia, K. 513*

Fernando Corena, bass; Orchestra of the Royal Opera House, Covent Garden, Argeo Quadri, cond.  
• LONDON 5585. LP. \$4.98.  
• LONDON OS 25219. SD. \$5.98.

This release's chief attraction—apart from its excellent sound—is the bass's splendid performance of the Cimarosa intermezzo, easily the best on records. His versions of "Rivolgete a lui lo sguardo" (the discarded aria for Guglielmo from *Così fan tutte*) and "Un bacio di mano" are also outstanding. The grand concert aria and the buffo scena are different matters, however; and though the spirit of Corena's renderings is always right, the vocalism is often ungainly, with the singer guiding his voice around the turns only imprecisely. The arias themselves, of course, are among the greatest examples of the form, and in the absence of a Pinza, many will be happy to settle for Corena in order to hear them. In any event, the Cimarosa alone justifies the disc. Notes, but no texts, which is especially unfortunate with respect to *Il Maestro di Cappella*, where a précis cannot mirror the text's affectionate wit. C.L.O.

HUMOROUSLY NEW!!!!!!!

Peter SELLERS & SOPHIA Loren  
International filmdom's brightest stars get together for an uninhibited record romp! (S) 35910  
Another "must"! Peter Sellers' comedy hit THE BEST OF SELLERS (S) 35984

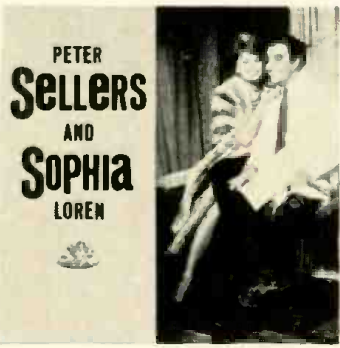

SYMPHONICALLY NEW!!!!!!!



Beethoven: Symphony No. 5 "King Stephen" Overture  
Otto Klemperer conducting The Philharmonia Orchestra.  
(S) 35843

**BRAHMS: THE FOUR SYMPHONIES**  
(And Two Overtures—"Tragic" and "Academic Festival")  
Otto Klemperer conducting The Philharmonia Orchestra.  
Deluxe boxed set of "one of the most satisfying projects in the history of recorded music." *Hi Fi/Stereo Review*.  
(S) 3614-D



Sibelius: Symphony No. 2  
Herbert von Karajan conducting The Philharmonia Orchestra.  
(S) 35891

**DVORAK: Legends, Op. 59**  
Czech Philharmonic Orchestra, Karel Sejna, cond.  
• SUPRAPHON LPV 311. LP. \$5.98.

Dvořák's ten *Legends*, composed in 1881, belong to the same period and style as the *Slavonic Dances*, the first set of which dates from 1878. Like the *Dances*, the *Legends* were originally written for piano duet and later orchestrated by the composer. Their form is simple and their many attractive melodies have that same artless folklike character that has endeared the *Dances* to so many listeners. The Czech Philharmonic can usually be counted upon to give idiomatic performances of Dvořák's music, and they do not disappoint here. Sejna directs with warmth and spirit, and the recording is more than satisfactory in range and spaciousness. This is the only version currently in the catalogue; it fills the need very well indeed. P.A.

BALLET-ICALLY NEW!!!!!!!



**CHOPIN: LES SYLPHIDES**  
**MEYERBEER: LES PATINEURS**  
**PONCHIELLI: DANCE OF THE HOURS**  
Charles Mackerras conducting The Philharmonia Orchestra.  
(S) 35833



CIRCLE 9 ON READER-SERVICE CARD

Continued on page 102

# new! *outstanding value*

## Electro-Voice®

### ULTRA-COMPACT SPEAKER SYSTEMS

### *in kit form*

Now Electro-Voice takes the mystery out of ultra-compact speaker systems. No longer are the components a "sealed" secret. You see what you get, know what you get, and enjoy the fun and economy of building your own speaker system. All the materials and instructions you need are included in the package. These new kits are exactly the same as the carefully-designed, assembled systems currently sold by Electro-Voice. Systems that produce a clarity of sound that enable you to feel the deepest bass, marvel at the effortless clarity in the midrange, and delight in the brilliant definition of the upper harmonics.



#### Performance Depends on Component Quality

Within each Electro-Voice system, every component is engineered to complement perfectly the others with which it is used. Some of the outstanding features you'll be receiving are illustrated in the cutaway view of the Esquire 200 featured above: (1) Substantial magnetic circuits for maximum sensitivity, power handling capacity, and uniformity of response. (2) High compliance viscous damped cloth suspension for smooth response and low resonant frequency. (3) Edgewise-wound voice coil for most effective use of available magnetic energy. (4) Die-cast frames for greatest reliability of performance. (5) True electrical cross-over, at exceptionally low frequency of 200 cycles, to minimize all forms of distortion associated with the use of woofers covering the midrange. (6) Midrange speaker in a totally isolated cavity for outstandingly uniform response throughout the range over which it is employed. (7) Sonophase® throat structure and integral diffraction horn to give virtually unequalled high frequency response range, with excellent coverage of the whole listening area. (8) Two level controls which permit exact adjustment of response characteristics to personal taste and individual acoustic environments.

#### A Variety of Prices and Performance

The Esquire 200—Now the value-packed Esquire is available in three different forms . . . the handsome Esquire 200, the economical unfinished Esquire 200 Utility and the new Esquire 200 Kit. Each is a full three-way system with a 12" woofer, 8" cone-type mid-range speaker and E-V Super Sonax very-high-frequency driver. Esquire 200—14" high x 25" wide x 13½" deep. Hand-rubbed Walnut, Mahogany or Lined Oak . . . \$133.00. Esquire 200 Unfinished Fir Utility—14" high x 23½" wide x 12" deep . . . \$107.50. Esquire 200 in easy-to-assemble Kit form—14" high x 23½" wide x 12" deep . . . \$93.00.

The Regal 300—A premium-quality, three-way system utilizing the finest quality components to assure the best sound possible in a small-sized system. Deluxe 12" woofer, a Deluxe 8" cone-type midrange speaker, and a compression-type, diffraction horn-loaded very-high-frequency driver. 14" high x 25" wide x 13½" deep. Walnut, mahogany, or limed oak . . . \$179.00. Unfinished fir . . . \$149.00. In Easy-to-assemble Kit Form . . . \$125.00.

Consumer Products Division

## Electro-Voice

Dept. 414H, Electro-Voice, Inc., Buchanan, Michigan

CIRCLE 46 ON READER-SERVICE CARD

ENESCO: *Rumanian Rhapsody, No. 1, in A, Op. 11*—See Liszt: *Hungarian Rhapsody, No. 2, in C sharp minor*.

GOULD: *Fall River Legend: Ballet Suite. Interplay for Piano and Orchestra. Latin-American Symphonette: Tango and Guaracha*.

Morton Gould and His Orchestra.  
• RCA VICTOR LM 2532. LP. \$4.98.  
• • RCA VICTOR LSC 2532. SD. \$5.98.

All of the music on this record has been employed for the ballet. *Fall River Legend*, one of Morton Gould's best scores in the serious vein, was composed especially to accompany Agnes de Mille's choreography for the balletic retelling of the Lizzie Borden murder case and has been an important staple of Ballet Theatre's repertoire ever since its premiere in 1948. *Interplay*, one of the most delightful of Gould's works, acquired its present title from Jerome Robbins' choreographic transformation, currently danced by both Ballet Theatre and the New York City Ballet. It was originally written in 1943 for José Iturbi, and was then known as *American Concertette for Piano and Orchestra*. Both the San Francisco and Marquis de Cuevas Ballets have adapted the *Tango and Guaracha*, the two middle movements of the *Latin-American Symphonette*.

Gould has always had a flair for presenting colorful performances of his own music, and these may be considered authoritative concert interpretations, if not particularly well adapted to actual dance performances. Everything is played with

careful attention to detail, yet with ample rhythmic verve. The composer's solo piano work in *Interplay* is properly brilliant, and he tears off the final movement in truly virtuosic fashion.

I have nothing but praise for Victor's sound here. In mono it has plenty of sparkle, but in stereo, where each section is pinpointed in an acoustically live studio, it is unusually lifelike. P.A.

HANDEL: *Ode for St. Cecilia's Day*

Adele Addison, soprano; John McCollum, tenor; Rutgers University Choir; New York Philharmonic, Leonard Bernstein, cond.

• COLUMBIA ML 5606. LP. \$4.98.  
• • COLUMBIA MS 6206. SD. \$5.98.

There are some fine things in this work, and it is good to have it available again, in a meritorious performance. (The only other LP recording of it, a poor job much cut, was removed from the domestic catalogues some time ago.) Bernstein's approach seems to me entirely unexceptionable. He gives the complete work and uses Handel's instrumentation practically throughout, with a discreet but effective realization of the continuo on an organ. The minuet of the Overture has grace, the "sharp violins" of No. 8 are crisply represented, nowhere is there any romantic exaggeration or stylistic misstep. Miss Addison sings steadily and with attractive quality, though the voice seems a bit thin on top; she produces a real trill, instead of the trembling on a single tone that often passes for one. Mr. McCollum's pleasant tenor is musically employed, but needs more brass for such a number as the stirring

"The trumpet's loud clangour." The unnamed trumpeter, by the way, is first-class, as are John Wummer, flute, and Laszlo Varga, cello, in their obbligato work. Good sound in both versions. N.B.

HAYDN: *Quartet for Strings, in D, Op. 64, No. 5 ("The Lark")*—See Richter: *Quartet for Strings, in C, Op. 51*.

HINDEMITH: *Sonata for Oboe and Piano*

†Loeffler: *Two Rhapsodies for Oboe, Viola, and Piano*

Harold Gomberg, oboe; Milton Katims, viola; Dimitri Mitropoulos, piano.  
• COLUMBIA ML 5603. LP. \$4.98.

The Hindemith is vivid, perky, light-textured, active—everything, in short, that one would expect from a sonata for oboe and piano by this composer. The Loeffler, on the other hand, lets one down, and rather cruelly. It was a famous piece once, and its composer was a famous man; now, however, Loeffler's aristocratic impressionism seems mere sentimentality. The recording and performance are close to perfection. A.F.

JANACEK: *On the Overgrown Path*

Ilija Hurnik, piano.  
• SUPRAPHON LPV 307. LP. \$5.98.

Janáček had two series of piano pieces known as *On the Overgrown Path* ready

Continued on page 106

**COLUMBIA** presents flawless sound on pre-recorded tape

Your choice of 2 or 4-track

Here are basics for your tape library

My Fair Lady—Original Broadway Cast OQ 310/TOB 43\*  
The Sound of Music—Original Broadway Cast OQ 311/TOB 58\*  
Camelot—Original Broadway Cast OQ 344/TOB 100\*  
Viva!—Percy Faith CQ 321/GCB 15\*  
'S Marvelous—Ray Conniff CQ 319/GCB 14\*  
Sing Along with Mitch—Mitch Miller and the Gang CQ 329/GCB 28\*  
Dvořák Symphony No. 5 ("From The New World")—  
Bruno Walter conducting MQ 339/LMB 59\*  
Orff: Carmina Burana—Soloists and  
The Philadelphia Orchestra,  
Eugene Ormandy, conductor MQ 347

ASK YOUR COLUMBIA DEALER

\* 2-Track

© "Columbia", ® Marcas Reg. Printed in U. S. A.

CIRCLE 36 ON READER-SERVICE CARD



# Wharfedale

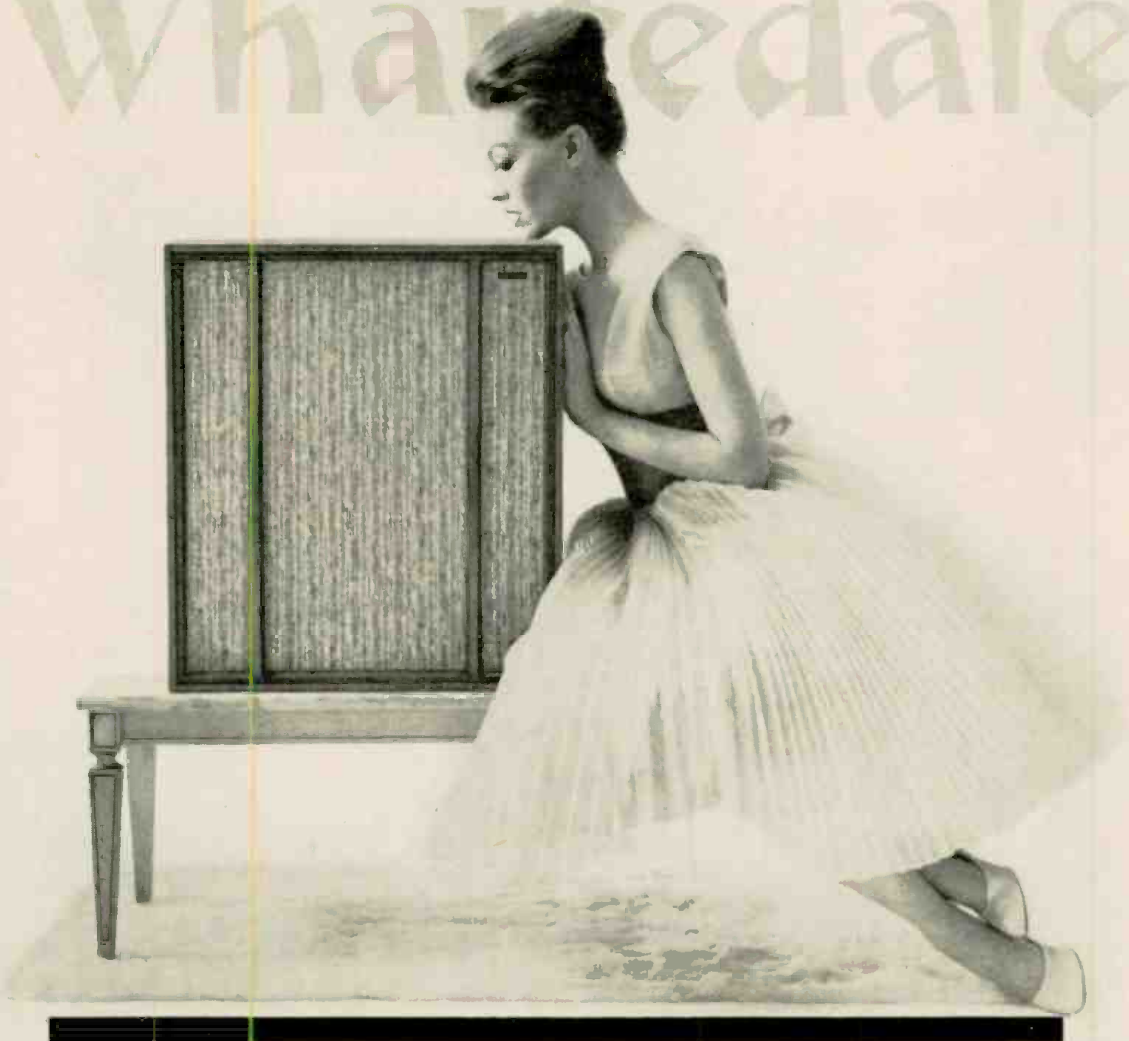

## W 70...Achromatic three speaker system...latest expression of the **WONDER OF WHARFEDALE!**

Today, a promise of perfection is fulfilled. It's the promise of Achromatic high fidelity reproduction... the pure sound, non-colored by extraneous modulations... providing a musical image justifying critical comparison with the live performance it reflects. The natural sound which distinguishes the W 70 is achieved through Wharfedale's exclusive inert sand-filled panel. Vibrations are damped, false cabinet resonances eliminated; and the three Wharfedale speakers, integrated with the handsome enclosure, are free to perform as a single unit. The full range of sound is exceptionally smooth, never strident; transient response in the bass is exceptionally clean. Your dealer in fine high fidelity components will be pleased to demonstrate the remarkable qualities of the W 70, the only speaker system which can claim to outperform the W 60, which with its smaller companion the W 50, keynoted the year's development in speakers.

.....  
\* Available in decorator-designed true wood veneer. Oiled Walnut, Polished Walnut, Mahogany and Lined Oak.

W 70 164.50, Utility Model 146.50

W 60 116.50, Utility Model 101.50

W 50 99.50, Utility Model 84.50

The unfinished utility models are styled without curved moldings, dividers.

.....  
MAIL THIS COUPON TO DEPT. WD21, BRITISH INDUSTRIES CORP., PORT WASHINGTON, NEW YORK

Please send Wharfedale achromatic series literature.

Name

Address

City  State

Wharfedale, a Division of British Industries Corporation, Port Washington, N. Y.





**ROGER WILLIAMS** • Cheek to Cheek • I Could Have Danced All Night • That Old Black Magic • I Get A Kick Out Of You • Papa, Won't You Dance With Me? • All Of Me • The Tender Trap • and others  
KL-1222 • KS-3222



**LOLITA** • Great German stars sings her hit, Sailor (Your Home Is The Sea) • La Luna • Paper Roses • My Little Corner Of The World • Theme From A Summer Place • all in German as well as other German favorites.  
KL-1219 • KS-3219



**JOSE JIMENEZ** • AT THE HUNGRY I • Recorded on location at San Francisco's famous night club, including Jose the Astronaut, Any Questions? • and others  
KL-1238 • KS-3238



**THE FOUR LADS** • Catch A Falling Star • Sixteen Tons • Everybody Loves A Lover • Hernando's Hideaway • Memories Are Made Of This • High Hopes • The Hawaiian Wedding Song • Come On-a- My House • Melodie D'Amour • & many others  
KL-1224 • KS-3224



**ROGER VOISIN, John Rhea; The Kapp Sinfonietta** conducted by Emanuel Vardi. Works by Stanley, Purcell, Bach, Legrenzi, Telemann, Daquin, Aftenburg  
KCL-9050(S)

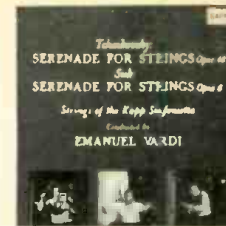

**TCHAIKOVSWY & SUK** • Serenades For Strings, Strings Of The Kapp Sinfonietta, Conducted by Emanuel Vardi  
KCL-9054(S)



**THE HI LO'S** • Clap Yo' Hands • Mam'selle • Lulu's Back In Town • Indian Summer • The Touch Of Your Lips • You And The Night And The Music • and others  
KL-1194

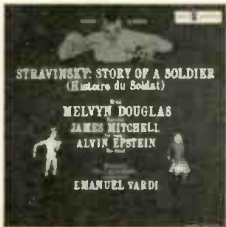

**STRAVINSKY: The 20th Century's most important composer. STORY OF A SOLDIER (Histoire du Soldat).** The only complete performance available. MELVYN DOUGLAS, Narrator with James Mitchell, Alvin Epstein. The Kapp Sinfonietta conducted by Emanuel Vardi  
KDC-6004(S)

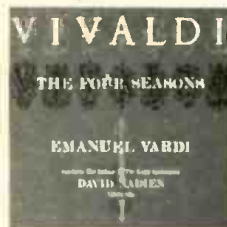

**VIVALDI: THE FOUR SEASONS** Emanuel Vardi conducts. The Strings Of The Kapp Sinfonietta. David Nadien, Violin Solo  
KCL-9056(S)

For sound bugs who love great entertainment



**MEDALLION RECORDS**  
a product of Kapp Records

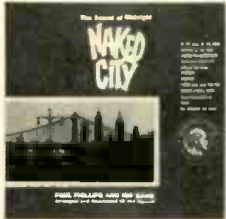

**PAUL PHILLIPS AND HIS BAND** • This is the city — full of sound — full of fury — ever awake. Here, at midnight you will find the honkey-tonk, the sophisticate, the storekeeper, the hoodlum, the ubiquitous cab driver...all blending together to give you the naked sound and soul of a city.  
MS-7517



**PERCUSSION UNLIMITED.** New interpretation of the dazzling melodies from "The Show Of The Century", designed for listening or dancing • On The Street Where You Live • Wouldn't It Be Lovely • I Could Have Danced All Night • and others  
MS-7514

# Feathers in our Kapp

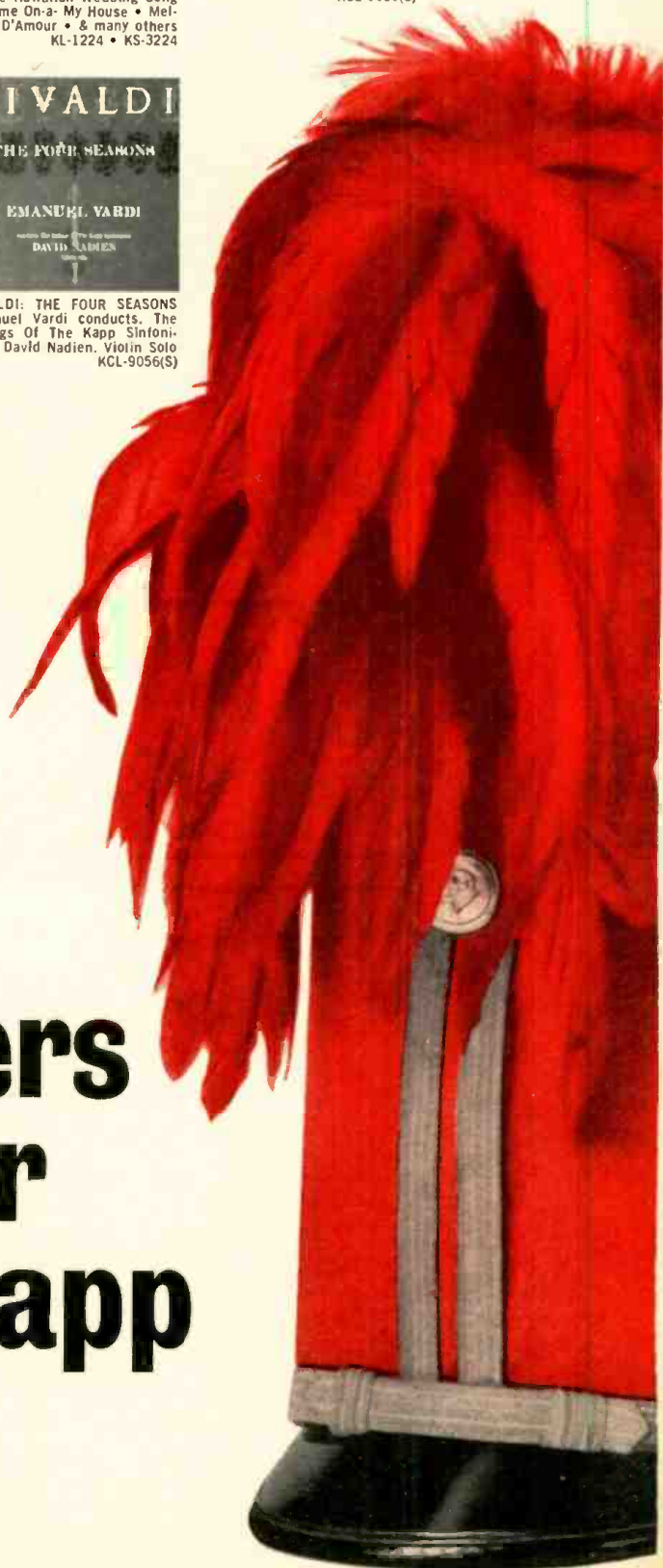

Medallion Records also available in monaural and 4-track 7 1/2 ips stereo tape.

CIRCLE 129 ON READER-SERVICE CARD



**JANE MORGAN** • The Ballad of Lady Jane • Kisses Sweeter Than Wine • Scarlet Ribbons • Greensleeves • The Foggy, Foggy Dew • I Know Where I'm Goin' • Molly Malone • Turtle Dove • The Riddle Song • Cotton Eyed Joe • and others  
KL-1191 • KS-3191

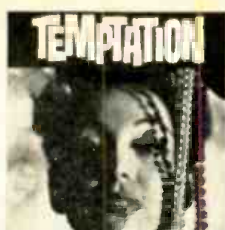

**ROGER WILLIAMS** • Temptation • Theme From "The Apartment" • Theme From "The Sun-downers" • Never On Sunday • La Montana (If She Should Come To You) • Little Rock Get Away • It's Now or Never • Riviera Concerto • and many others  
KL-1217 • KS-3217(T)

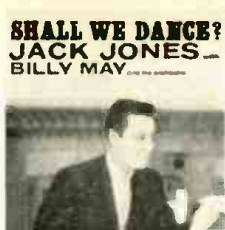

**JACK JONES With Billy May and His Orchestra** • Shall We Dance? • Dancing On The Ceiling • Carioca • Change Partners • The Spin I'm In • Ballerina • Invitation • A String Of Pearls • Takes Two To Tango • Dixieland Band • & others  
KL-1228 • KS-3228(T)



**THE RED MILL** • The Vienna Theater-Konzert Orchestra under the direction of Conrad Lieder. The music of Victor Herbert's greatest operetta.  
KL-1227 • KS-3227



**THE PETE KING CHORALE** • The Sound of Music • My Favorite Things • The Lonely Goatherd • Sixteen Going On Seventeen • No Way To Stop It • Climb Ev'ry Mountain • and others  
KL-1175 • KS-3059



**THE PETE KING CHORALE** • Hey! Look Me Over • Tall Hope • Corduroy Road • Give Me A Little Whistle (And I'll Be There) • One Day We Dance • You've Come Home • El Sombrero • Wildcat • Oil • What Takes My Fancy • Ain't It Sad? • and others  
KL-1223 • KS-3223(T)



**OPERA WITHOUT WORDS** • A MASKED BALL (Verdi) • The Rome Symphony Orchestra under the direction of Domenico Savino  
KCL-9051(S)

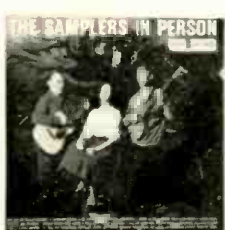

**THE SAMPLERS** • Ballad Of Railroad Bill • Donkey Riding • Mi Amor, Mi Corazon • Oh Lord, I Oone Done • On My Way And I Won't Come Back • Where, Oh, Where? • Swiss Marching Song • and others  
KL-1232 • KS-3232



**THE DO-RE-MI CHILDREN'S CHORUS**—songs children love to sing  
Do-Re-Mi • High Hopes • Old MacDonald Had A Farm • The Happy Wanderer • Alouette • Mairzy Doats • My Favorite Things • 76 Trombones • He's Got The Whole World • Three Little Fishes • & many others  
KL-1177 • KS-3177



**THE DO-RE-MI CHILDREN'S CHORUS**—songs children love to sing  
Do-Re-Mi • High Hopes • Old MacDonald Had A Farm • The Happy Wanderer • Alouette • Mairzy Doats • My Favorite Things • 76 Trombones • He's Got The Whole World • Three Little Fishes • & many others  
KL-1234 • KS-3234

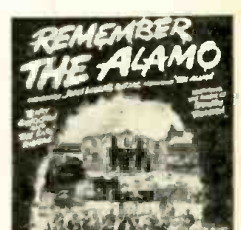

**TERRY GILKYSON AND THE EASY RIDERS** • Inspired by John Wayne's Batjac Production of "The Alamo" featuring the music of Dimitri Tiomkin. The Green Leaves of Summer • The Girl I Left Behind • Laredo • Ballad Of The Alamo • and others  
KL-1216 • KS-3216(T)



**THE MEDALLION STRINGS** directed by Emanuel Vardi • Great Melodies from the latest movies, in a blaze of brilliant sounds, including themes from "The Apartment", "The Sun-downers", "The World Of Suzie Wong", "Never On Sunday", "The Apartment", "The Sun-downers", "The World Of Suzie Wong", "Never On Sunday", "The Alamo", "Midnight Lace", • and others  
MS-7513



**Instrumental favorites by LANI ROYAL with THE DIAMOND HEAD BAND.** An exciting musical spectacular from the 50th State, with famous selections that capture the charm and the exotic landscape of those exotic tropical islands! Sweet Liliani • Beyond The Sea • Blue Hawaii • and many others  
MS-7516

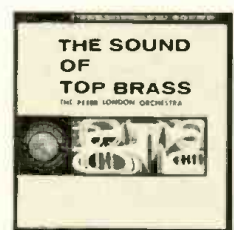

**THE PETER LONDON ORCHESTRA.** Fascinating portraits in brass, painted in wonderfully exciting sound. Includes: Cachita • Among My Souvenirs • Sabre Dance • Mambo #5 • You Made Me Love You • The Toy Trumpet • Holiday For Strings • and others  
MS-7500



**MICHAEL LEIGHTON & HIS ORCHESTRA.** A sparkling showcase of string instruments—subtle textures and bold contrasts in startling new sound. Includes: Cheek To Cheek • Imagination • As Time Goes By • Sleepy Lagoon • I Had The Craziest Dream • and others  
MS-7502



**THE MEDALLION MARCHING BAND** under the direction of David Terry. The thunder of drums, the crash of cymbals, the blaze of brass—nothing is as exciting as a marching band! Twenty-four favorite college marches, plus Sousa "immortals"—a whole parade of marches!  
MS-7507

HOW TO KEEP YOUR FRIENDS IN A SPIN...nothing makes a guest's head whirl with more admiration than a host who is thoughtful enough to have a goodly supply of Kapp Records handy! Why Kapp in particular? Because, in general, (be it classic, baroque or ballad, voice or instrumental) you can count on Kapp for the sounds you want to hear performed by the most exciting artists in the world of music. Above, just a sampling of what we mean. Visit your record store or write for the complete, FREE Kapp Records magazine catalog.

# KAPP RECORDS

CIRCLE 130 ON READER-SERVICE CARD

**KAPP RECORDS, INC.**  
136 East 57th St., New York 22, N.Y.



**I want to hear more about the great Kapp artists and records. Please send me the FREE Kapp Records magazine catalog plus all the latest Medallion releases.**

Name \_\_\_\_\_  
Address \_\_\_\_\_  
City \_\_\_\_\_ Zone \_\_\_\_\_ State \_\_\_\_\_

# OPERA

at its best



## DIE FLEDERMAUS

J. Strauss

Hilde Gueden, Regina Resnik and Guest Stars, Herbert von Karajan—Vienna Philharmonic Orch.  
Stereo OSA-1319 Mono A-4347

## AIDA

Verdi

Renata Tebaldi, Giulietta Simonato, Carlo Bergonzi, Cornell MacNeil, Herbert von Karajan  
Stereo OSA-1313 Mono A-4345

## La Boheme

Puccini

Renata Tebaldi, Carlo Bergonzi, Ettore Bastianini, Cesare Siepi, Tullio Serafin  
Stereo OSA-1208 Mono A-4236

## DAS RHEINGOLD

Wagner

Kirsten Flagstad, George London, Set Svanholm, Georg Solti—Vienna Philharmonic Orch.  
Stereo OSA-1309 Mono A-4340

## LA FORZA DEL DESTINO

Verdi

Renata Tebaldi, Mario Del Monaco, Ettore Bastianini, Cesare Siepi, Giulietta Simonato  
Stereo OSA-1405 Mono A-4408

## TURANDOT

Puccini

Inge Borkh, Mario Del Monaco, Renata Tebaldi  
Stereo OSA-1308 Mono A-4320

## PETER GRIMES

Britten

Peter Pears, Claire Watson, Benjamin Britten  
Stereo OSA-1305 Mono A-4342

## Cavalleria Rusticana

Mascagni

Giulietta Simonato, Mario Del Monaco, Cornell MacNeil, Tullio Serafin  
Stereo OSA-1213 Mono A-4240

Write for free complete catalog  
LONDON RECORDS, INC.  
Dept. KB 539 W. 25 St., N.Y. 1, N.Y.

CIRCLE 73 ON READER-SERVICE CARD

for publication in 1908. The date is interesting, since the first series, especially, is in the musical stream typified by the introspective, sensitive, and imaginative style of Schumann's *Scenes from Childhood*. The source of inspiration is poetic remembrance of persons, feelings, nature, and the moods range from a gay, though lyric, polka called *Come with Us* to the somber drama of the tale told (in *Death and the Maiden* terms) in the final piece of the first series of ten pieces.

In contrast to this romantic aura is often to be found a kind of piano writing foreshadowing Bartók or Prokofiev. Janáček here uses the piano as a non-vibrating instrument in a sudden, eruptive, and sharp figuration; or he uses constant rhythmic reiteration of an accompanying idea; or he uses seconds and sevenths (as in the *vivo* movement of the second series) very much *à la* Bartók. Yet, for all the reminiscences these techniques bring to mind, Janáček is very much his own man. There is a wonderful Slavic tint to his melodies and a sophistication to his musical thought and organization.

Ilja Hurnik gives these pieces the sensitive, delicate but incisive and rhythmic performance they merit in this very satisfying recording. STANLEY LOCK

KABALEVSKY: *Twenty-four Preludes, Op. 38*

Yakov Flier, piano.  
• MK-ARTIA 1530. LP. \$5.98.

There is cause for irritation if a composer sets out to write twenty-four preludes—one in each major and minor key (shades of Bach's "48," Chopin, Shostakovich!)—and ends up with a crashing bore of a piece. The irritation becomes all the greater when he can produce certain pieces—such as numbers 9, 11, or 19—of true charm, wit, rhythmic vitality, while others sound like poor-man's Prokofiev or use the "wrong note" approach to attain a contemporary sound. Yakov Flier seems to do his level best to give them a good performance, but what with having to deal with every cliché known to man and transcription maker plus a rather dull, thick-sounding piano, he can hardly be expected to achieve the most stimulating results.

STANLEY LOCK

LALO: *Symphony in G minor*—See Bizet: *Symphony in C*.

LISZT: *Chants polonais (6)*—See Chopin: *Ballades*.

LISZT: *Hungarian Rhapsody, No. 2, in C sharp minor*

†Enesco: *Rumanian Rhapsody, No. 1, in A, Op. 11*

†Smetana: *My Country: No. 2, Vltava ("Moldau")*. *The Bartered Bride: Overture*

RCA Victor Symphony, Leopold Stokowski, cond.

• RCA VICTOR LM 2471. LP. \$4.98.  
• RCA VICTOR LSC 2471. SD. \$5.98.

Affixed to the jacket of this record (issued as "Rhapsodies") is a sticker, which I quote in full: "WIZARD AT WORK (Handle With Care). Voluptuous new interpretations by that Merlin of orchestral witchery STOKOWSKI whose magic

wand, abetted by demon engineers at RCA Victor, has evoked the most seductive, glowing, sublime SOUND ever accorded these brilliant rhapsodies. Take one to your lair . . . enchant yourself."

Now, anyone who knows his witchcraft and his roundtable knows there are two schools of thought about wizards, witches, and Merlin; they could work either for good or for evil. There can be no question about Stokowski's beneficent wizardry in drawing from his pickup orchestra, obviously some of the best performers in town, a rich, refined tone. But his "magic wand" (since when has he conducted with anything but his hands?) doesn't work the same kind of magic on the music. Almost every phrase of the Liszt and Enesco rhapsodies is stretched out of shape by the wizard's whims, and he chooses to chop off the final chord of the Enesco. He is much kinder to the two Smetana works, where every detail is brought out with care. Here, however, is a general lack of animation, made even more evident by a curious slackening of the tempo in the lyrical middle section of the overture.

As for the "demon engineers," the term is indeed apt. The hall they selected for the session is so cavernous and resonant that reverberation muddies up most passages. Then too the microphone setup for both mono and stereo is such that strings, harps, and a few woodwinds are unduly emphasized at the expense of some of the brasses. Knowing Stokowski's interest in improved sound recordings and transmission, I am surprised that he was satisfied to put his stamp of approval on this disc. But then, maybe even wizards are human. P.A.

LOEFFLER: *Two Rhapsodies for Oboe, Viola, and Piano*—See Hindemith: *Sonata for Oboe and Piano*.

MARTINU: *Bouquet of Flowers*

Czech Singers' Chorus and Children's Chorus; Libuše Domanínská, soprano; Sona Cervená, contralto; Lubomír Havlák, tenor; Ladislav Mráz, bass; Czech Philharmonic Orchestra, Karel Ančerl, cond.

• SUPRAPHON LPV 445. LP. \$5.98.

The title is extremely well chosen. The work is a cantata, based on Czech folk texts, in eight movements, three for orchestra and five for the singers. The musical setting is also beholden to folklore, in its general character if not in its specific materials. The effect of the whole is of a long string of entrancingly beautiful tunes handled simply, but with the utmost liveliness, vivacity, and bounce. At times one is reminded of the Stravinsky of *Les Noces*, at other times of the Bartók of the *Cantata Profana*, and at still other times of Carl Orff; but the piece has a unity of style all its own, and I find it the most charming work of Martinů on records. Performance and recording are very distinguished. A.F.

MENDELSSOHN: *Concerto for Violin and Orchestra, in E minor, Op. 64*—See Bruch: *Concerto for Violin and Orchestra, No. 1, in G minor, Op. 26*.

Continued on page 108

HIGH FIDELITY MAGAZINE

Read what Audio Magazine has to say about the

# FORTISSIMO XK 8000 SERIES

"This special series by Riverside is the best one yet."

"The Fortissimo series anticipates playback equipment considerably better than what we have today."

"All these steps produce a stereo disc unlike any I've heard before."

"Conventional surface noise is totally absent and response is phenomenal."

"Once the word gets around, these will be the test records in the months ahead."



REPRINTED FROM AUDIO MAGAZINE

CHESTER SANTON

## Light LISTENing



This special series by Riverside is the best one yet. The first feature you'll notice in these stereo discs is the fact that they play from the inside out. But that's only a very small part of the story. The tone arm starts right next to the label with a short band containing a 400-cycle test tone for channel balancing. Once the locked groove at the end of this band is hurdled, the pickup then proceeds toward the outer edge of the record.

Cutting the master disc from the inside out has long been advocated as a solution to the problem now encountered in classical recordings wherever a symphonic work closes with a loud finale at the end of a lengthy side. Unfortunately, the four initial releases in this series do not contain classical material. We won't know how the theory works until some one puts out a stereo disc with an "1812 Overture" that starts next to the label. The Fortissimo series anticipates playback equipment considerably better than what we have today. Their master tapes are recorded at 60 inches per second with the heads oriented

horizontally. Of even greater significance to the record fan are the measures that have been taken to improve the transfer from tape to disc. These include a 92,000 cps tone superimposed over the regular signal while cutting the master disc. It seems that the conventional hot stylus technique cannot do as good a job in the harder material they are using for this series. The finished pressings contain a new and harder compound called Polymax. All these steps produce a stereo disc unlike any I've heard before.

Of the four translucent discs released so far, these two records offer the most convincing evidence of the changes this series could make within the industry. Conventional surface noise is totally absent and response is phenomenal. The pipe organ played by Paul Renard is the second Wurlitzer located in the Radio City Music Hall building. This smaller version of the main theatre organ is located in a studio atop the building that was originally intended for radio broadcasts. Miked at extremely close quarters, the sound of the studio organ has a gleam impossible to capture in the vast auditorium. The music is sure-fire stuff by George M. Cohan. The 27-year old Paul Renard doesn't have the polish and poise of the veteran theatre organists but he sails into these show stoppers with a complete quota of enthusiasm. This record won't be studied for the performance of the music. The attraction is the sound just as it is in the companion release of jet planes and a helicopter recorded at Eglin Air Force Base in Florida. In high and low fly-by, take-off and landing, these jets have the "live" quality formerly available only on 15 ips professional tapes. Once the word gets around, these will be the test records in the months ahead.

Stereo only — At quality record shops and audio stores everywhere . . . \$5.98

# FORTISSIMO

Produced by the Electronic Research And Development Division of Riverside Records • 235 W. 46th Street, New York 36, N. Y.

CIRCLE 53 ON READER-SERVICE CARD

APRIL 1961

107

## Record Connoisseurs!

*elect!* help choose the music to be recorded!  
*select!* Look at the list below—available only direct-to-you immediately!

**PURCELL:** *Indian Queen, Opera*, Anthony Bernard cond. London Chamber Singers, Orch. & Soloists. In orig. English. M-1 Only!

**HANDEL:** *Ode On St. Cecilia's Day*, Anthony Bernard cond. London Chamber Orch. Soloists: Teresa Stich-Randall, Alexander Young. English by Dryden. M-2 or 5-2

**HANDEL:** *Organ Concerti*, Op. 4/1, 4/2, 4/4, 7/1. Ralph Downs, Org., London Chamber Orch., Anthony Bernard, Cond. M-3 or 5-3

**RAMEAU:** *Six Concerts En Sextuor*, Chamber Orch. of Toulouse, Louis Auriacombe conducting. M-4 or 5-4

**BACH:** *Cantata #79 "Gott der Herr"; Cantata #32 "Liebster Jesu"*. Chamber Orchestra of the Sarre, Chorus & Soloists, Karl Ristenpart, cond. Sung in German. M-5 or 5-5

**BACH:** *Cantata #82 "Ich habe genug"; Cantata #159 "Sehet wir gehen"*. Same performers as M-5. Sung in German. M-6 or 5-6

**JEAN OCKEGHEM:** *Three Motets*. Instr. and vocal ensemble, cond. by Roger Blanchard.

**JOSQUIN DES PRES:** *Missa (Hercule D'Este)* Vocal ensemble, in Latin. M-7 or 5-7

**SCHUTZ:** *The Resurrection, Kammerchor of Salzburg Mozarteum and soloists, Ernst Hinreiner cond. Sung in German.* M-8 Only!

**BEETHOVEN:** *Piano Trio, Kakadu Var. Op. 121 A.*

**BRAHMS:** *Piano Trio Op. 87. Albeneri Trio: Artur Balsam, P., Giorgio Ciompi, Vn., Benar Heifetz, Vc. Ready in March.* M-9 or 5-9

**HAYDN:** *Piano Trio #3 In C Major.*

**MOZART:** *Piano Trio K 548; Piano Trio K 564. Albeneri Trio. Ready in March.* M-10 or 5-10

**Mono records \$5.50 ea. Stereo \$6.50 ea.**

The Music Guild now brings you these and other hitherto unobtainable works, with every detail of each record—done with a connoisseur's taste and musical integrity. You may join the Music Guild as a Member and vote for the works you want recorded, or you can limit your participation to the purchase of records. In either case you are not committed to buy! These records are superb, fully guaranteed, individually boxed with complete texts and notes. Send for your free copy of the Music Guild Newsletter with information on how to become a Member and get a 25% discount on records you buy now, and other details. Order now!

*The Music Guild*  
INCORPORATED

THE MUSIC GUILD, INC. H-1  
111 W. 57th St., New York 19, N.Y.

Send the records checked below.  
I enclose check or M.O. for \$.....  
including 50¢ for postage and packing. I understand I am under no obligation to buy any further records, and that if I become a Member later, I will receive a 25% discount on all records I have bought.

I would like to know more about the Music Guild. Please send me my free copy of the Newsletter.

MONAURAL		STEREO	
M1 <input type="checkbox"/>	M6 <input type="checkbox"/>	NONE <input type="checkbox"/>	\$6 <input type="checkbox"/>
M2 <input type="checkbox"/>	M7 <input type="checkbox"/>	\$2 <input type="checkbox"/>	\$7 <input type="checkbox"/>
M3 <input type="checkbox"/>	M8 <input type="checkbox"/>	\$3 <input type="checkbox"/>	NONE <input type="checkbox"/>
M4 <input type="checkbox"/>	M9 <input type="checkbox"/>	\$4 <input type="checkbox"/>	\$9 <input type="checkbox"/>
M5 <input type="checkbox"/>	M10 <input type="checkbox"/>	\$5 <input type="checkbox"/>	\$10 <input type="checkbox"/>

Name .....  
PLEASE PRINT

Address .....

City ..... Zone ... State .....

CIRCLE 84 ON READER-SERVICE CARD

**MIASKOVSKY:** *Symphony No. 27, in C minor, Op. 85*

U.S.S.R. Radio Symphony Orchestra, Alexander Gauk, cond.

• MK-ARTIA 1524. LP. \$5.98.

Nicolai Miaskovsky is the most prolific symphonist to attain international recognition since the eighteenth-century. Forty years ago his early symphonies were played everywhere; then the much more individual Shostakovich began to assert himself and Miaskovsky was largely forgotten except in his native country. There, however, his reputation stands higher than that of any twentieth-century composer, with the possible exception of Shostakovich and Prokofiev. The only symphony of his previously released on American discs is the Nineteenth, which is for band, and is not a very good work.

The Twenty-seventh and last symphony of Miaskovsky, written in 1950, the year of his death, is a highly honorable piece of academic music, noble in intention and elegant in execution, with a slow movement which Shostakovich himself might envy. Both the recording and the performance are first-class. In this instance, at least, the case for Miaskovsky is splendidly put. A.F.

**MOZART: Concert Arias—See Cimarosa: Il Maestro di Cappella.**

**MOZART: Concerto for Piano and Orchestra, No. 24, in C minor, K. 491**

†Scriabin: *Concerto for Piano and Orchestra, in F sharp minor, Op. 20*

Dimitri Bashkirov, piano; U.S.S.R. State Radio Orchestra, Alexander Gauk (in the Mozart), Kiril Kondrashin (in the Scriabin), conds.

• ARTIA ALP 168. LP. \$4.98.

Mr. Bashkirov, a young Russian pianist who has been visiting this country, turns from Mozart to Scriabin without any fuss and manages to convey something of the special quality of each. The Mozart is clean and in general stylish, although there are some bothersome lapses—conductor and soloist do not maintain the sweep with which the first movement begins, Bashkirov slows up for a single cantabile passage in that movement, and some of the forte portions of the finale are played rather heavily. In the Scriabin I could detect no flaws. Here, without exaggerating, Bashkirov conveys all of the poetry and nuance in the fragrant chromaticism of this delicate and Chopinesque work. Even in its most fervent passages he maintains a singing tone, and technical problems seem not to exist for him.

The orchestral playing is satisfactory, the balances, except for a moment or two in the Mozart, are just, and the sound, save for a bit of mud in the basses, is good. N.B.

**MOZART: Ein Musikalischer Spass, K. 522; Suite for Winds from Die Entführung aus dem Serail; Divertimento in B flat, K. 196f**

Members of the NDR Symphony Orchestra, Christoph Kopp, cond. (in K 522); Wind Ensemble from SDR (in Suite); Detmold Wind Sextet (in K. 196f).

• ARCHIVE ARC 3150. LP. \$5.98.  
 •• ARCHIVE ARC 73150. SD. \$6.98.

The novelty here is the arrangement, for pairs of oboes, English horns, French horns, and bassoons, of eight numbers, including the Overture, from *Die Entführung*. We know that Mozart made a transcription for winds of music from this opera, but it is not claimed that the present one is his. It is, however, well made, except for one or two awkward spots, and the perkier pieces make pleasant listening in this guise. The Divertimento, which survives in a version for eight winds and another for six, is played in the latter here. It is early, and middle-grade, Mozart. The delicious parody of a bumbling amateur composer is played here not by a sextet but by a small orchestra, as Mozart seems to have intended. The performers are all excellent and the sound is good in both versions. N.B.

**MOZART: Twelve Duos for Horns, K. 487**

†Beethoven: *Sextet for Two Horns and Strings, Op. 81b*

Christopher Leuba, Paul Binstock, horns; Lenox String Quartet.

• AUDIOPHILE AP 70. LP. \$5.95.

The Mozart Duets, which seem not to have been recorded before, are interesting examples of what that master could provide for two unreliable instruments of very limited abilities. They include four minuets and a polonaise, and the most striking passages occur in the trios of the minuets. The Beethoven is an early work, with a ceremonial first movement, a routine Adagio, and a standard hunting-call finale; only in the momentary flare-ups of drama in the development sections of the fast movements is the great master faintly foreshadowed. Mr. Leuba is first horn of the Chicago Symphony Orchestra and Mr. Binstock is active in Minneapolis. Their playing—and they have tricky things to do in both works—is impeccable; nothing is wanting in tone, agility, and accuracy of intonation. The disc's sound is quite acceptable. N.B.

**PROKOFIEV: Romeo and Juliet, Op. 64**

Bolshoi Theatre Orchestra, Gennady Rozhdestvensky, cond.

• MK-ARTIA 205 C. Three LP. \$17.94.

Few ballet scores in history are so rich, so varied, so full of entrancing tunes, dramatic effects, orchestral riches, and Shakespearean romance as the score of Prokofiev's *Romeo and Juliet*. The three suites drawn from it have been recorded often, and there have been previous recordings of the entire monumental work, but this seems to be the only recording of all fifty-two movements now available. Rozhdestvensky, chief conductor of the Bolshoi Ballet, is thoroughly master of the music and he gets reasonably good cooperation from the instrumentalists and recording engineers. One would be more enthusiastic if only the first violins of the Bolshoi would play together and in tune. It is unsettling to think of listening over and over again to a symphonic work more than two hours long

Continued on page 110

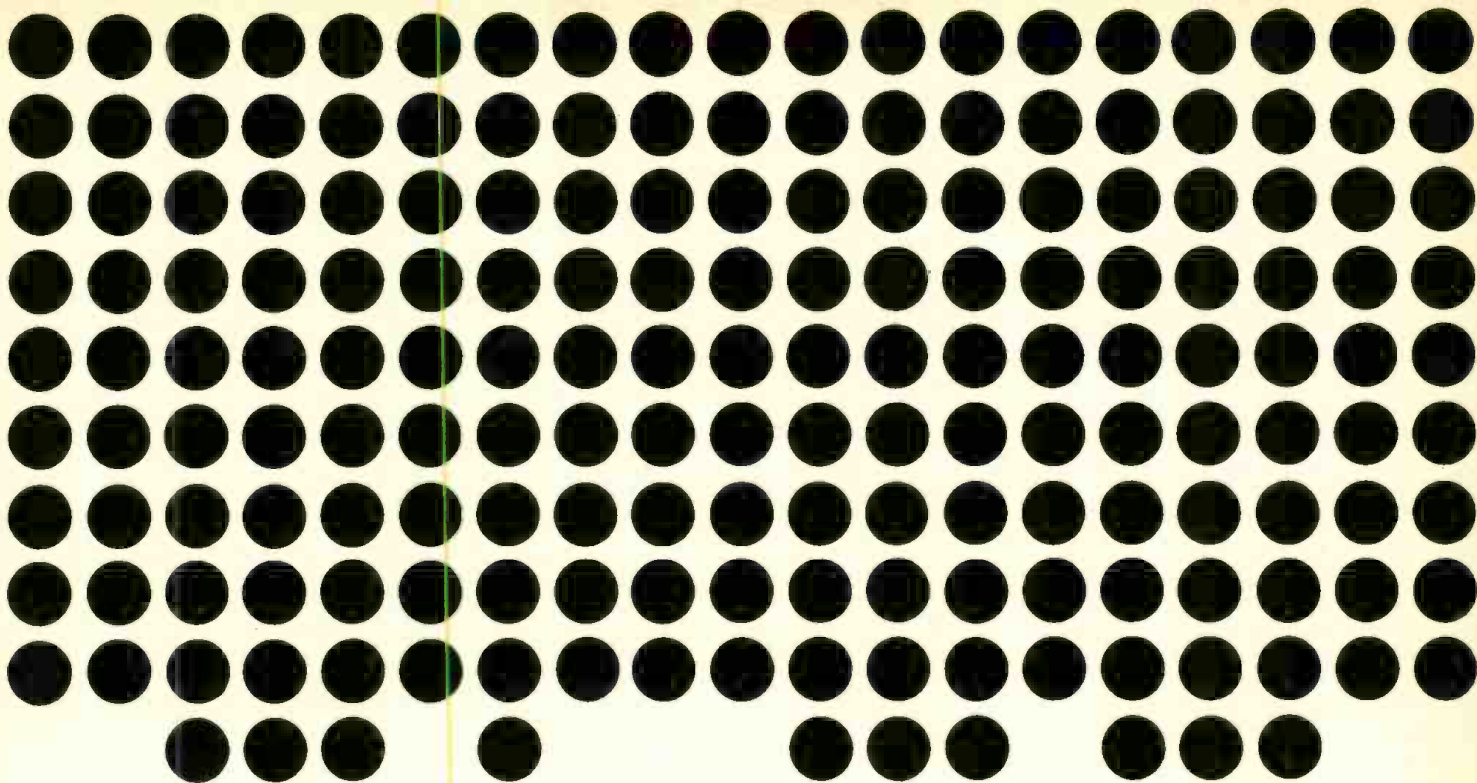

**stereo: persuasive/provocative/percussive**

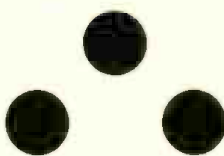

*Just Released!*

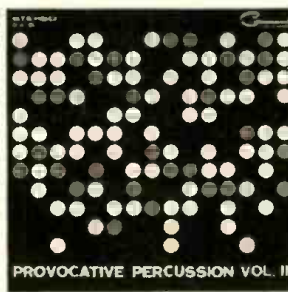

*Just Released!*

### taming the temperamental harpsichord

The musical score of one of **COMMAND**'s newest albums called for an unexpected harpsichord . . . and that was a problem. An English harpsichord with the best of reputations was shipped across the sea. But the trick was, how to capture and hold its sonically temperamental sounds within a complex orchestration. 35 microphones were tested until **COMMAND** technicians selected the one that would faithfully sustain and blend quick-silver harpsichord notes into the music. Taming the harpsichord is only one innovation that makes **COMMAND** the ultimate in stereo sound.

**COMMAND is Stereo** . . . These are the records that made the critics say: . . . Stereo didn't make **COMMAND**; **COMMAND** made Stereo! Because it took **COMMAND** to finally give you the great new sound . . . the new musical excitement stereo promised. That's why **COMMAND** records are consistently #1 and #2 on America's best seller stereo charts. So technically perfect, **COMMAND** records are used by most stereo and hi-fi equipment manufacturers to demonstrate true fidelity.

### 4 INCOMPARABLE ALBUMS JUST RELEASED BY **COMMAND**!

**FAR AWAY PLACES** starring Enoch Light and his orchestra, featuring harpsichord and exotic percussion. **RS 822 SD.**

Incredibly rich and shimmering arrangements—Calcutta, Waltzing Matilda, Banana Boat Song, Third Man Theme, 8 others. Discover an unexpected harpsichord, temple blocks, bongos, guiros, claves.

**PROVOCATIVE PERCUSSION VOLUME III. RS 821 SD.**

The latest addition to the series that reveals what stereo is all about. Even more technically and musically perfect than its predecessors. The Continental, Adios Muchachos, Let's Oo It, Theme from Exodus and 8 more.

**THE PERSUASIVE TROMBONE OF URBIE GREEN** and his orchestra. **RS 815 SD.**

The most polished, versatile trombone playing today by Urbie Green. At Last, Moonlight Serenade, My Silent Love, Let's Fall in Love, 8 others.

**ROMAN GUITAR**, featuring Tony Mottola and his orchestra. **RS 816 SD.**

Under his talented fingers, the strings sing, they soar, croon and leap into sudden dancing gaiety. Sorrento, Non Dimenticar, Arrivederci Roma, 9 others.

**NATIONAL LIST PRICE:**  
**COMMAND MONAURAL \$4.98**  
**COMMAND STEREO \$5.98**  
**COMMAND 4-TRACK TAPE \$7.95**

*the greatest advance  
 in sound since  
 hi-fi was invented*  
**Command**  
 records

SONOGRAF LOUDSPEAKER SYSTEMS  
Unique, four component, designs, now offer  
FULL STEREO IN DEPTH—REGARDLESS  
OF THE POSITION OF THE LISTENERS  
Model 253-SS, Complete Teak \$169.50

SONOGRAF ELECTRIC COMPANY  
37 East 28 Street, New York 16, N.Y.

Jobo turntable  
Seas loudspeakers

CIRCLE 110 ON READER-SERVICE CARD

## THE AMERICAN STEREOGRAPHIC CORPORATION (ASCO RECORD CORPORATION)

17 West 60th Street  
New York 23, New York

### Presents a new Series: GREAT ARTISTS OF THE PAST & PRESENT

1. Lauritz Melchior (2-record set): Greatest heroic tenor of all time (A-121)\*
2. Elizabeth Rethberg (1 record): Foremost lyric-spinto of our time (A-115)
3. Giovanni Martinelli (2-record set): Golden Anniversary issue for the foremost Italian tenor of the past forty years (A-116)
4. Rosa Ponselle (2-record set): Commemorating thirty-five years of recording by this century's greatest dramatic soprano (A-125)
5. Giuseppe de Luca (1 record): The 50th Anniversary Town Hall Concert by this great baritone (A-124)
6. TO COME: May release: Kirsten Flagstad (2-record set): Covering forty years of the career of the foremost Wagnerian soprano of our time.

\*High Fidelity (Feb. 1961). "ASCO Deserves a Loud Cheer and a Rush of Orders."

### INSTRUMENTAL RELEASES

1. Great Violinists of the Past: Sarasate, Joachim, Auer, Ysaye, Kubelik (A-123)
2. Great Pianists of the Past: D'Albert, Sauer, Nikisch, Strauss, Grieg, Carreno, Debussy, Busoni, DePachmann, Granados, Leschetizky, Dohnanyi, Saint-Saens, Paderewski & Rachmaninoff (A-119)

### STEREOGRAPHIC RELEASES

1. Carmen Excerpts (1 record): 50 minutes of highlights with four Metropolitan opera stars: Irra Petina, Frank Valentino, William Horne & Frances Yeend. Orchestra of the Maggio Musicale Fiorentino conducted by Erasmo Ghiglia (A-101)
2. Nobucco Excerpts (1 record): 55 minutes of highlights of the Verdi opera with Nicola Rossi-Lemeni, Lawrence Winters, Norma Giusti, etc. Orchestra and chorus of Hamburg, Germany (A-106)
3. Famous Italian & French Operatic Overtures and Intermezzi: Orchestra of the Maggio Musicale Fiorentino conducted by Erasmo Ghiglia (A-103)
4. Strauss Waltzes: The most popular of the Viennese master's creations played by the Hamburg Philharmonic Orchestra (A-102)

### ANTHOLOGIES

1. Italian Operatic Anthology from 1600-1950: A score of great composers and a score of great singers (A-114)
2. Israeli Hit Parade: Fifteen songs of an Old-New Land sung by the famed Israeli operatic tenor, Nico Feldman (A-118)
3. Harp Collection: Featuring works of Bartok, Handel, Komaromi, Tournier, Donizetti & Von Wurtzler. Played by Aristid Von Wurtzler.

Suggested List Price: { Monaural Releases: \$3.98  
Stereographic Releases: 4.98

CIRCLE 7 ON READER-SERVICE CARD

with the violins always out of tune in the same places. A.F.

PROKOFIEV: *Sonata for Cello and Piano, in C, Op. 119*

†Beethoven: *Sonata for Cello and Piano, No. 3, in A, Op. 69*

André Navarra, cello; Alfred Holeček, piano.

• SUPRAPHON LPV 468. LP. \$5.98.

Prokofiev's big, broad, melodious, superbly made sonata has previously been recorded by such celebrities as Janigro, Piatigorsky, and Rostropovitch, while Casals, Fournier, Starker, and others provide the competition against which this disc must make its way so far as the Beethoven is concerned. It all seems a little formidable, yet Navarra is an elegant cellist, Holeček is an elegant pianist, and the disc comes off very well. A.F.

RAAIJMAKERS: *Contrasts*—See Badings: *Capriccio for Violin and Two Sound Tracks*.

RACHMANINOFF: *Symphonic Dances, Op. 45*

†Casella: *Paganiniana*

Philadelphia Orchestra, Eugene Ormandy, cond.

• COLUMBIA ML 5605. LP. \$4.98.

• COLUMBIA MS 6205. SD. \$5.98.

The *Symphonic Dances*, Rachmaninoff's last large-scaled compositions, were intended to be used with choreography by Fokine, but the latter died before these plans could materialize. Best of the three dances, in my opinion, is the first, which has a stark, thoroughly vibrant rhythmic impulse and (for Rachmaninoff), boldly modernistic harmonic touches. The other two are also among Rachmaninoff's finer works, but they are not so clearly constructed.

Alfredo Casella's mélange of Paganini caprices was assembled into a highly spiced orchestral pepper-pot soup for the Vienna Philharmonic's centennial celebration in 1942. The result was a bustling, highly active little suite, expertly orchestrated. Ormandy's performance of it on this disc doesn't have the tonal refinement and infectious bounce that I recall hearing from a reading by the late Guido Cantelli and the NBC Symphony, but in its own flashy way, the present rendition is very effective indeed. And the Rachmaninoff dances are stunningly presented.

The recorded sound is truly fantastic. The stereo has an engulfing resonance that adds fullness to the Casella suite, but the flatter, more pointed monophonic pressing gives greater impact in the first Rachmaninoff. I have no clear preference for one or the other edition. H.G.

RICHTER: *Quartet for Strings, in C, Op. 51*

†Haydn: *Quartet for Strings, in D, Op. 64, No. 5 ("The Lark")*

Smetana Quartet.

• SUPRAPHON ALPV 393. LP. \$5.98.

Those who like to search for unfamiliar chamber music will consider this a prize.

Continued on page 112

HIGH FIDELITY MAGAZINE



# SHERWOOD



Introduces

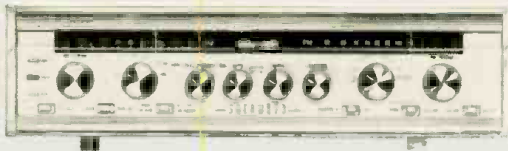

New S-7000  
Stereo FM/AM Receiver  
50 watts \$299<sup>50</sup>

only for those who want the ultimate . . .

. . . a triumph in combined components, the S-7000 brings together in one unit the incomparable features of Sherwood's FM and AM tuner circuitry along with two 25-watt amplifiers, two pre-amplifiers and stereo controls. The S-7000 needs only the addition of speakers to complete a basic stereo system. Overall size, just 16 x 4 x 14 inches deep.

. . . a dramatic new furniture concept—Sherwood **Correlaire Modules**—styled with a contemporary flair in hand-rubbed Walnut and Pecan woods. Sixteen interchangeable modules for truly flexible room arrangements, the perfect setting for your Sherwood components. Sherwood Electronic Laboratories, Inc., 4300 N. California Ave., Chicago 18, Illinois.

FOR COMPLETE TECHNICAL DETAILS WRITE DEPT. 4 H

## BUY SHERWOOD AT ONE OF THESE FINE DEALERS

For others, see "Hi Fidelity" section of Yellow Pages.

- CALIF.**, Culver City, Hi Fi Matt Co.  
Inglewood, Olson Radio Corp.  
Los Angeles, Kieruff Sound Corp.  
Paradise Hi Fi  
Pasadena, Hi Fidelity House  
Oakland, Fisher Elec. Co.  
Sacramento, Hi Fi Sound Supply  
San Diego, Audio Enterprises  
San Francisco, Eber Electronic Supply  
San Jose, House of Hi Fi
- COL.**, Denver, The Electric Accessories Co.
- CONN.**, Bridgeport, Bridgeport Electronic  
Hartford, Dressler Electronics  
New Haven, Radio Shack Corp.
- DEL.**, Wilmington, D & M Radio & Elec. Co.
- D.C.**, Washington, Custom Hi Fi Radio & TV  
Emco Wholesalers
- FLA.**, Miami, High Fidelity Associates
- GA.**, Atlanta, High Fidelity SSS
- ILL.**, Chicago, Allied Radio Corp.  
Schwartz Bros. Hi-Fi Studios  
Evanston, Allied Radio Corp.  
Highland Pk., Columbia Hi Fi  
Rockford, Component Hi Fi
- IND.**, Hammond, Tri City Electric Co.  
Indianapolis, Graham Electronic Supply  
Van Sickle Radio Supply  
South Bend, Al Smith's Hi Fi Sound
- IOWA**, Davenport, TCR Distributors  
Des Moines, Iowa Sound Services
- KY.**, Louisville, Hi Fi Trading Post
- LA.**, Baton Rouge, Odden Park Record Shop  
New Orleans, Hi Fi Inc.
- MD.**, Baltimore, American Distr. Co.  
Bethesda, Audio Center
- MASS.**, Boston, Audionics Company  
Radio Shack Corp.
- MICH.**, Ann Arbor, Ann Arbor Radio & TV Serv.  
Dearborn, Hi Fi Studios  
Detroit, K.L.A. Laboratories  
Grand Rapids, House of Sound
- MINN.**, Duluth, Mel's Sales & Service  
Minneapolis, Audio King  
Lew Bonn Company
- MO.**, Kansas City, David Beatty  
St. Louis, Hi Fi West  
Hollander & Company
- NEBR.**, Omaha, House of Hi Fi
- N. J.**, Camden, General Radio Supply Co.  
Montclair, Perdue Radio Company  
Mountainside, Federated Purchaser Inc.  
Newark, Sound Reproduction Inc.  
Paramus, Music Age, Inc.  
Patterson, Magnetic Recording Co.  
Springfield, Disco Electronics Inc.  
Trenton, House of Hi Fi
- N. MEX.**, Albuquerque, Audio Center
- N. Y.**, Albany, Fort Orange Radio  
Bethpage, S & R Electronics, Inc.  
Brooklyn, Recco Camera  
Cedarhurst, Concert Hall Audio  
Hempstead, Newmark & Lewis  
Ithaca, Alcor, Inc.  
Jamaica, Lafayette Radio Corp.  
Audio Exchange  
Lockport, Lockport Audio Center  
New York, Airex Radio Corp.  
Grand Central Radio, Inc.  
Harvey Radio  
Lafayette Radio  
Leonard Radio, Inc.  
Terminal-Hudson Radio  
Poughkeepsie, Dutchess Television  
Rochester, Jerry Fink Company  
Syracuse, W. G. Brown Sound Equip.  
Tuckahoe, Boynton Studios  
White Plains, Westchester Elec. Supply
- OHIO**, Akron, Electronic Engg.  
Olson Radio Corporation  
Cincinnati, Steinberg's Inc.  
Cleveland, Custom High Fidelity  
Olson Radio Corporation  
Columbus, Eastmoor Hi Fi Center  
Dayton, The Stotts-Friedman Co.  
Parma, Winteradio Elec.  
Toledo, Jamieson's Hi Fidelity  
Youngstown, Armes Electronics
- OKLA.**, Norman, Thomson Sound Systems  
Tulsa, Sound Unlimited
- ORE.**, Portland, High Fidelity Unlimited Inc.
- PENN.**, Philadelphia, Radio Elec. Service Co.  
Radio 437 Store  
Reading, Geo. D. Barbey Co.  
Wayne, High Fidelity House
- R. I.**, Providence, Audionics Company
- TENN.**, Knoxville, McClung Appliances  
Nashville, Electra Distr. Company
- TEXAS**, Corpus Christi, Greene's Music Shop  
Dallas, Custom Music  
Hillcrest Records & Hi Fi  
El Paso, El Paso Audio Center  
Ft. Worth, Audio Associates  
Houston, Sound Equipment  
San Antonio, Vandergriff Audio Co.
- VA.**, Arlington, Audio Associates  
Falls Church, The Television Workshop  
Sales Inc.
- WASH.**, Spokane, Twentieth Century  
Sales Inc.
- WISC.**, Madison, Hi Fi Corner  
Milwaukee, The Hi Fi Center  
Tosa Recording, Inc.
- CAN.**, Ottawa, Akins High Fidelity  
Toronto, Bay Bloor Radio  
Tele Tech Electronics, Ltd.
- HAWAII**, Honolulu, Music City

CIRCLE 108 ON READER-SERVICE CARD

# STRAND PERCUSSION'S BIG 3 AT ITS BEST!

STEREO INTRODUCTORY PRICE (Regularly \$5.98) **\$2.98**



**HAWAIIAN PERCUSSION**  
BILLY MURE blends great guitar with superb rhythmic percussion on "Hawaiian War Chant," "Song Of The Islands," "Blue Hawaii" plus!

SLS 1010

**LATIN PERCUSSION**  
JOSEPH MATTERA presents pulsating, exciting percussion with "Jungle Drums," "Amapola," "Malaguena" and more.

SLS 1017



**AROUND THE WORLD IN PERCUSSION**

BILLY MURE traverses the globe on the winds of thrilling percussion via "Around The World," "In A Persian Market," "Petticoats of Portugal," etc.

SLS 1021

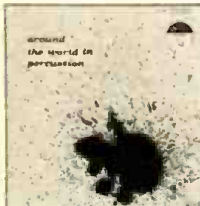

**IT'S STRAND** for the very best in Percussion, Vocals, Instrumentals, Humor and Variety singles and albums. If Your Local Record Dealer Is Sold Out Of Strand Percussion You May Order Direct

### STRAND RECORDS

157 West 57th Street, New York 19, N. Y.  
Enclosed is \$... in payment for... copy of Around The World In Percussion  Hawaiian Percussion  Latin Percussion  at the special introductory price of \$2.98 each.

Name .....

Address .....

Please send check or money order only  
**THIS OFFER EXPIRES JULY 1, 1961**

CIRCLE 114 ON READER-SERVICE CARD

## This is a laughing matter

In the last few years, young bright new comedians have burgeoned on records — Shelley Berman, Lennie Bruce, Bob Newhart, Mort Sahl, Tom Lehrer, to name some. Their fresh, new brand of humor — sophisticated and often "sick" — is fast replacing parlor games as a source of entertainment for social evenings at home. What's new in this field on records? Simple — just refer to the *latest* monthly issue of the "Schwann Long Playing Catalog." If you haven't got the latest issue, better hurry to your record dealer's and get it — if you want to have the last laugh.

CIRCLE 103 ON READER-SERVICE CARD

112

Richter (his first names were František Xaver) was a Czech master associated with the Mannheim school, where he played from 1747-69 in the orchestra then universally regarded as the greatest in eighteenth-century Europe. The quartet shows full mastery in string writing and proves a strong and varied work, quite equal to a place among the secondary achievements of more famous composers. The Smetana artists play it very well and give further evidence of their accomplishments in the Haydn. Engineering is good, and the record (made in Czechoslovakia) is quite worth a premium price. R.C.M.

**RIMSKY-KORSAKOV: Scheherazade, Op. 35**

Hamburg International Philharmonic Orchestra. Wilhelm von Luden, cond.  
• • Tops 6008. SD. \$1.49.

This record has a real distinction. It is the worst *Scheherazade* on stereo, and perhaps on all discs. In a sense, the orchestra earns its name of "International"; its members might be scattered all over the European continent, so rarely are they together in their playing. There is scarcely one measure where the attacks are precise or on the beat.

All of which makes one wonder whether Herr Wilhelm von Luden exists at all. In fact, one wonders too where the engineers were. The recording's presence and channel separation are not bad, but the channels appear to have been reversed, with the violins coming from the right. P.A.

**ROSSINI: Overtures**

Philharmonia Orchestra, Herbert von Karajan, cond.

• ANGEL 35890. LP. \$4.98.  
• • ANGEL S 35890. SD. \$5.98.

Virtuosity is here in abundance, but not the Latin caress that would put the performances among the best. The *Semiramide* rendition, though, is the best I've encountered recently. In any case, the matter of choosing a selection of Rossini overtures from among the myriad versions available has become little more than a caprice; admirers of orchestral dash and punctilio will find these performances satisfying. The sound is fine, but some background noises are noticeable during the *William Tell*. C.L.O.

**SCARLATTI: Sonatas for Harpsichord (20)**

Wanda Landowska, harpsichord.  
• ANGEL COLH 73. LP. \$5.98.

This transferral to microgroove of six 78-rpm discs recorded at Paris in 1934 needs no excuses because of its age. Although the sound has the nasal quality characteristic of old recordings of the harpsichord, it is entirely acceptable still; it neither veils nor distorts the dynamic and tonal nuances of the playing to any consequential degree. Like Landowska's performance of Bach in the same series, this is indeed one of the "Great Recordings of the Century." Three of the sonatas—in C, L. 104; in D, L. 463; and in E, L. 375—are familiar to all pianists, but the rest are not. They are striking choices from the vast inventory left by their remarkable composer, well calculated to display his extraordinary variety of mood and character.

One need not follow Landowska's notes in every fanciful detail in order to appreciate the eloquence of her playing. Whether in the majestic courtliness of L. 23, the airy wit of L. 208, the tense drama of L. 294, or the brilliant voluptuousness of L. 474, she is completely the mistress of her instrument and of the style. Only one of these sonatas, L. 475, is also in the set recorded by Ralph Kirkpatrick. It is fascinating, and, it must be admitted, a bit chastening, to see how entirely plausible each of these two quite different conceptions can be on its own terms. N.B.

**SCHUBERT: Symphony No. 5, in B flat; Symphony No. 8, in B minor ("Unfinished"); Symphony No. 9, in C**

Columbia Symphony Orchestra (in Nos. 5 and 9), New York Philharmonic (in No. 8), Bruno Walter, cond.

• COLUMBIA M2L 269. Two LP. \$9.98.  
• • COLUMBIA M2S 618. Two SD. \$11.98.

**SCHUBERT: Symphony No. 9, in C**

Amsterdam Concertgebouw Orchestra, Josef Krips, cond.

• RICHMOND B 19078. LP. \$1.98.

I have yet to find a Bruno Walter performance that does not contain things worthy of his place among the master conductors of our day. Yet this Schubert

Continued on page 117

HIGH FIDELITY MAGAZINE

Study for Library of Congress finds

## LEKTROSTAT®

best for cleaning records

"Routine cleaning was accomplished by using... prior to playback or packaging; a sparingly applied detergent solution with an applicator of sheared acetate velvet fibres.\*

"Other systems of dust control, cleaning (such as spray on anti-static compounds, treated cloths, dampened synthetic sponges, and radioactive air ionization) were tried but did not prove as satisfactory."

\*Lektrostat Record Cleaning Kit, Dexter Chemical Corp.

Only \$2.00 net at your high fidelity dealer's, or write to:

## DEXTER

Chemical Corporation  
Consumer Prod.  
Division  
845 Edgewater Rd.  
New York 59, N. Y.



CIRCLE 40 ON READER-SERVICE CARD

set is an uneven affair. It contains some careless tape editing (a collision with a music stand is preserved in the second movement of the *Unfinished*) and some bad ensemble that could easily have been corrected in a retake.

The primary weakness of the three performances is demonstrated at the start of the Fifth (the one recording of the group which has been issued previously). It is impossible for me to accept Walter's tempo here. As he states the theme, it simply moves too slowly to preserve a proper contour, and the entire performance has a quite inappropriate slack quality. If you contrast this version with Beecham's, you'll see my point.

In the Ninth, Walter sets slow basic tempos and permits himself a good deal of flexibility in speeding up and slowing down the subsections of the movements. The trouble, unfortunately, is that here too the line of the work suffers. Contrasting this set with the Furtwängler, for example, one can't help noticing that, however slow the pace, Furtwängler always maintains a firm sense of movement in the music while Walter sometimes seems to dawdle. I have deliberately chosen an example from the tradition Walter shares. Neither Furtwängler nor Walter, in my estimation, challenges the achievement of Toscanini in this music. It would be unfair to suggest that Walter's performance lacks great things. His statement of the swirling finale must be cited as such. It is a very individual conception, beautifully played, and there are other such pages. But, taken over-all, this is not as satisfying a Ninth as the monophonic versions cited or Krips's stereo disc.

The Richmond reissue of Krips's mono recording gives full value for its modest price, but I myself would get the newer set.

The new Walter version of the *Unfinished* is in the direct line of his earlier performances. Here too the tempos are slow and the over-all effect is very relaxed and lyrical. It suits this music better than it does the other two symphonies. Although I prefer a somewhat more powerful and dramatic statement of the score, I fully recognize that Walter has carried his interpretative approach to logical and artistically defensible ends. Certainly, if you enjoyed his previous recordings of this symphony, you will want this new one. R.C.M.

#### SCHUMANN: *Song Recital*

*Songs from the Spanish: Der Kontrahandiste; Zigennerliedchen 1 and 2; Tief im Herzen trag ich Pein; Melancholie; Sehnsucht; Geständnis: O wie lieblich ist das Mädchen; Weh, wie zornig ist das Mädchen; Der Hidalgo; Ebro caudoloso. Songs from Myrthen: Widmung; Der Nussbaum; Lieder aus dem "Schenkenbuch im Divan," Nos. 1 and 2; Die Lotoshlune: Aus den Hebraischen Gesängen; Zum Schluss; Mein schöner Stern.*

Dietrich Fischer-Dieskau, baritone; Jörg Demus, piano.

• DEUTSCHE GRAMMOPHON LPM 18655. LP. \$5.98.

• DEUTSCHE GRAMMOPHON SLPM 138655. SD. \$6.98.

The *Spanish Songs* are settings of some of Emanuel Geibel's German versions of Spanish poems, which, of course, fur-

## TWO GRAND PIANISTS FROM EUROPE

The exciting Italian pianist

MAURIZIO

**POLLINI**

WINNER OF THE 1960 INTERNATIONAL CHOPIN COMPETITION, WARSAW



The distinguished French virtuoso

ERIC

**HEIDSIECK**

TWO LANDMARKS OF THE CLASSICAL CONCERTO



**CHOPIN:** CONCERTO NO. 1 IN E MINOR with THE PHILHARMONIA ORCHESTRA • PAUL KLETZKI, conducting • Album No. (S) G 7241

"...I do not expect to hear the concerto played better!"  
Roger Fiske, *Gramophone*

**MOZART:** CONCERTO NO. 20 IN D MINOR, K. 466 • CONCERTO NO. 23 IN A MAJOR, K. 488 • Album No. (S) G 7240

"...wonderful fingers and musicianship to burn..."  
—*New York Journal-American*

THEIR RECORDING DEBUTS ON



CIRCLE 32 ON READER-SERVICE CARD

## Listening Post to the world of Opera

Britain's only magazine devoted entirely to Grand Opera — "OPERA" — is your listening post to world performances. Vivid reports by British and Continental authorities, with graphic photographs, OPERA, founded by the Earl of Harewood, is essential reading for opera lovers.

Edited by Harold Rosenthal with regular contributions from John Warrack, Philip Hope-Wallace, William Mann, Andrew Porter and Desmond Shawe-Taylor.

So that you may enjoy and judge this magazine for yourself, mail the coupon below with \$1 bill or check, and three different specimen copies will be sent to you by return of post. Then you will want to have it sent to you regularly.

### Send \$1 for three specimen copies of OPERA

CLIP COUPON AND MAIL WITH \$1 BILL OR CHECK

To: OPERA, Rolls House Publishing Co. Ltd., Rolls House, Brems Buildings, London, E.C. 4, England  
I enclose \$1. Please send me three different specimen copies of OPERA.

NAME .....

ADDRESS .....

HF 61

CIRCLE 87 ON READER-SERVICE CARD

nished Wolf with much of his material for the *Spanisches Liederbuch*. One or two of them are quite atypical Schumann, and indeed *Der Kontrabandist* could almost be mistaken for a Wolf song. For my taste, Fischer-Dieskau sings the flowing lyric expressions (e.g., the second *Gipsy Song*, *Flutenreicher Ebro*) superbly, but in the others he tends to fall into a self-conscious display of vocal colors and textual underlinings.

The same, I think, is true of the selections from *Myrthen* on Side 2—*Der Nussbaum*, *Die Lotosblume*, *Mein schöner Stern* being the best of the lot, the others being rather tiring. But it may be I have just had an overdose of Fischer-Dieskau; when every month brings one or two new albums of Lieder by the same singer, it is difficult to listen with fresh ears. I am happy to note that DGG has included complete English translations, but it's rather too bad we don't have a word of the original. Demus is a sympathetic partner, and DGG's sound of highest quality. C.L.O.

**SCRIABIN:** *Concerto for Piano and Orchestra, in F sharp minor, Op. 20*—See Mozart: *Concerto for Piano and Orchestra, No. 24, in C minor, K. 491*.

**SHOSTAKOVICH:** *Five Preludes and Fugues, Op. 87; Concerto for Piano and Orchestra, No. 2, Op. 101*

Sviatoslav Richter, piano (in Op. 87);

Michael Voskresensky, piano; Prague Symphony Orchestra, Vaclav Jiracek, cond. (in Op. 101).

• ARTIA ALP 173. LP. \$4.98.

The Richter side of this disc is devoted to Nos. 3, 6, 7, 2, and 18 of the *Twenty-Four Preludes and Fugues*, composed in 1951. This modern *Well-Tempered Clavier*, like its predecessor, is full of wit, ingenuity, and spirit; not the least of its virtues is the brilliantly unexpected contrast always effected between the prelude and the fugue. The performance is the last word in virtuosity, and the recording is first-rate. The interpretation of the perky, brilliant, lithe, open-textured, and zestful concerto is much lighter than the others which have so far appeared on records and is all the more effective for that reason. The recording in this case too is excellent. A.F.

**SIBELIUS:** *Symphony No. 5, in E flat, Op. 82; Finlandia, Op. 26*

Rochester Philharmonic Orchestra, Theodore Bloomfield, cond.

• EVEREST 6068. LP. \$3.98.

• • EVEREST SDBR 3068. SD. \$4.98.

Interpretatively and sonically, this disc is not up to Everest's customarily high standards. There is little to the performance but the playing of bare notes, and even some of these are without refinement; expression seems to be missing altogether. As to the sound, it has a cramped quality, as if the orchestra were

playing in a small studio. Furthermore, a considerable amount of distortion is noticeable throughout the disc, most prominently towards the center. For a first-rate Fifth, try Sir Malcolm Sargent on EMI-Capitol. P.A.

**SMETANA:** *My Country: No. 2, Vltava ("Moldau"). The Bartered Bride: Overture*—See Liszt: *Hungarian Rhapsody, No. 2, in C sharp minor*.

**SMETANA:** *Quartets for Strings: No. 1, in E minor ("From My Life"); No. 2, in D minor*

Smetana Quartet.

• SUPRAPHON ALPV 420. LP. \$5.98.

It is rare to encounter Bedrich Smetana's two string quartets on the same record. In fact, it is rare to encounter disc representation of the Second Quartet at all. The familiar Quartet No. 1, in E minor, (*From My Life*) provides a beautifully effective combination of dramatic, somber, tender, and tragic elements. It reaches its emotional climax towards the end of the last movement, where a sustained high E in the first violin symbolizes the ringing sound in the composer's ears which signaled his approaching deafness. The Second Quartet, little known on this side of the Atlantic, followed six years after the First. It too is autobiographical, though in a less obvious, less dramatic way. It is shorter, more compact, and its movements often

# BOTH

## Special Introductory Offer

Your choice of 10 complete Stereo Tape Albums valued at \$6.95 and \$9.95 for the price of standard blank magnetic recording tape. One reel of music with one reel of blank tape (1200 ft. 1½ mil acetate - 7½ ips - 2 track or 4 track) in American's beautiful Twin-Pack. This exciting offer brilliantly demonstrates the superior quality of American Recording Tape.

- |                           |                              |
|---------------------------|------------------------------|
| ★ My Fair Lady            | ★ Gershwin                   |
| ★ Music by Leroy Anderson | ★ Grand Canyon Suite         |
| ★ Sound of Music          | ★ Glenn Miller Sound         |
| ★ World Famous Overtures  | ★ Tchaikovsky: 1812 Overture |
| ★ Gigi                    | ★ La Fiesta Brava            |

ASK YOUR DEALER OR WRITE TO

**Greentree Electronics**

2020 Placentia Ave., Costa Mesa, California



CIRCLE 57 ON READER-SERVICE CARD



# An Invitation TO PARTICIPATE IN ONE OF THE MOST EXCITING AND RICHLY REWARDING MUSICAL ENTERPRISES OF OUR TIME

THE COMPLETE

## Vivaldi

DR. PAUL HENRY LANG says, "This is not only a good project, it is an exciting one."  
LEONARD BERNSTEIN writes, "This is an invaluable project—not alone for musicological enlightenment—but also for sheer listening joy."

And fortunate Charter subscribers wrote such lyrical comments as, "I have never seen more perfection in the entire make-up of the album or heard more perfection of artistic grace in the music. It is truly magnificent."

Actually, the project that has evoked such lyrical enthusiasm is one that would have been looked upon as madness only a few years ago. It enables you to enjoy for the first time a completely new musical concept—"recording in depth" of the entire work of a great composer in performances following the authentic scores as they appear in the composer's own handwriting—especially recorded by leading artists with the most advanced fidelity techniques—unlimited exchange of worn or damaged records—and the authentic Ricordi scores of all the music—all at less than the scores alone would cost.

### The Music and the Performance

Although Vivaldi has only recently been coming into his own among music lovers, even now only a small part of his works has been recorded and this often in versions far from the spirit of the original. And even now not one music lover in a thousand is aware of the tremendous richness of Vivaldi's work and the extraordinary variety of instrumentation featuring not only strings and harpsichord, but flute, piccolo, oboe, bassoon, lute, viola d'amore, mandolin and others.

The music itself is recorded for subscribers by one of the country's outstanding musical groups, the New York Sinfonietta, under the direction of Max Goberman and with the cooperation of the finest soloists. Each record

contains four or more pieces widely varied in instrumentation, played exactly the way Vivaldi wrote them and using the actual instruments for which they were written. The attractive groupings of pieces make listening to each monthly release closely akin to attending a concert in Vivaldi's time.

### Recording Techniques

LIBRARY OF RECORDED MASTERPIECES recordings are made with the most advanced techniques on multi-channel stereo tapes and made available in both monaural and stereo records. The quality of sound has brought lavish praise from experts, and one subscriber wrote, "The finest records I have ever heard." Damaged or worn records may always be exchanged at nominal cost.

### A Word About Scores

An outstanding feature of these recordings is inclusion of the complete Ricordi scores made up under the editorship of Gian Francesco Malipiero from the original manuscript sources and providing the only authentic versions of Vivaldi's music as he himself wrote and conducted it.

Just one word about the use of scores. Anyone who can read simple notes can quickly find himself following the scores and entering a whole new world of musical understanding and enjoyment. As one subscriber has written: "I follow the score with the music. It does add to one's appreciation. But the score earned its price when our 13-year old daughter put it on her music stand and played the flute part."



### HOW YOU CAN PARTICIPATE

The LIBRARY OF RECORDED MASTERPIECES is not an ordinary record club. There are no free bonuses (except the remarkable index record—an exciting achievement in itself). If you are looking for records at bargain prices, this is NOT the place to find them. But if your interest is aroused by what have been called the finest recordings ever made then we invite you to share in the benefits of this unique club arrangement by enrolling now. The complete cost to subscribers for recording and scores each month is \$8.50, far less than the cost of the scores alone which would be \$12.00 to \$15.00 if purchased separately. Replacement records will be supplied at only \$3.00. Each month's shipment is billed separately and no minimum number of records need be purchased. Subscription may be terminated at any time.

We invite you to try this unique musical experience for yourself by returning the attached coupon and receiving your first record. You have no obligation to continue, if you do not wish to do so—and if you are not completely enthusiastic after listening to your record, you are free to return it to us for full refund. We want you to listen and enjoy for yourself. Why deprive yourself of this pleasure?

These recordings are not available in stores. This enables us to put a maximum of value into every record with its accompanying scores.

#### THE NEW YORK TIMES

"One of the most startling new recording projects, stupendous in scope and well worth the pains, is the LP recording (stereo and monaural) of the complete works of Antonio Vivaldi, which has been started by Max Goberman, director of the Library of Recorded Masterpieces. . . . Since the scores alone of the works recorded would cost some \$15.00, the price of \$8.50 for the LP volume of four concertos and scores plus historical and analytical notes by Joseph Braunschtein, seems a highly profitable investment. It is also an agreeable investment, for the performances, in which Mr. Goberman conducts the New York Sinfonietta, have a sense of style, engaging spontaneity and infectious enthusiasm. . . . One wishes Mr. Goberman Godspeed and success, in a project that must be rated a public service."

#### HIGH FIDELITY MAGAZINE

"With this disc, Mr. Goberman inaugurates one of the boldest recording adventures ever planned. An excellent beginning has been made. All four of these works are first-class Vivaldi and only two of them, as far as I can tell, are otherwise available on discs. The soloists play extremely well. . . . The conductor is in complete command of his forces at every moment, eliciting a variety of pace and dynamics as well as perfect precision."

#### THEMATIC INDEX RECORD

We invite you to receive at no extra charge one of the most remarkable records ever made. The Thematic Index Record includes full orchestral recording (with solo instruments) of the main themes of every movement of the 52 VIVALDI pieces already recorded by the Library. Included are printed musical texts of each theme and cross indices by key, by title, by solo instruments, for example—flute, violins, oboe, etc. This is the only record of its kind ever made—a record collector's dream. Although the price of this invaluable record is \$10.00, it is yours free with your first Vivaldi.



#### THE LIBRARY OF RECORDED MASTERPIECES

150 W 82nd St., N. Y. 24

#### LIBRARY OF RECORDED MASTERPIECES

150 West 82nd Street, New York 24, New York

Please enroll me as a VIVALDI subscriber and send me the current recording, notes and scores postpaid, for which I enclose \$8.50. Also send at no extra charge the new Thematic Index Record. If not satisfied, I can return both records for full refund. I can terminate membership at any time and need not take any minimum number of records.

Please Check:  Monaural  Stereo

Name .....

Address .....

City..... Zone..... State.....

Canadian Subscribers receive these Vivaldi records duty-free

HF-4

#### AN EXTRAORDINARY VIVALDI LIBRARY:

I would like to receive all 12 albums of the Complete Vivaldi, Volume 1, for which I enclose my check for \$102.00. Full Ricordi scores and musicological notes are included, plus the Thematic Index Record and a Vivaldi manuscript facsimile.

end abruptly. The composer here becomes more introverted: even the polka, which, as in the First Quartet, constitutes his second movement, is colored by restraint and sadness, while the slow movement takes the unexpected form of a fugue. There is less strength and perhaps less listening appeal in this later quartet, but it is nonetheless interesting.

The performances by the Czech quartet are sonorous and communicative. The recorded sound, too, is warm, though conservative in range. It was marred on the first side of my review copy by some distortion, which may have been the result of an inferior pressing. P.A.

**STRAUSS, RICHARD: Songs and Operatic Scenes**

*Verführung. Gesang der Apollonpriesterin. Elektra: Allein! Weh, ganz allein; Was*

*bluten muss? Orest! Orest! Die Aegyptische Helena: Der ist auferlegt; Zweite Brautnacht. Salome: Ah! Du wolltest mich nicht deinen Mund.*

Rose Pauly, soprano; Orchestra.  
 • INTERNATIONAL RECORD COLLECTORS' CLUB IRCC L 7018. LP. \$5.50. (Available from International Record Collectors' Club, 318 Reservoir Avenue, Bridgeport 6, Conn.)

In this country, Rose Pauly was known almost exclusively as a Strauss soprano, and it is fitting that this disc—which is, so far as I know, her first commercial LP presentation—is devoted entirely to music of Strauss.

The voice was basically a bright, strong one, not terribly well balanced, but capable of considerable variety of color. On some of these excerpts, it tends towards edginess, though this

quality is not inappropriate to the music. What makes her work remarkable is a combination of intensity and insight. She was a famous Elektra, and these passages show why—especially in the magnificent monologue from the Recognition Scene ("Orest! Orest!"). But for my taste, the most exciting portion of this record is the final scene of *Salome*. I do not know the origin of this recording (it seems probable that it is from a broadcast, as the *Elektra* excerpts surely are) or the identity of the conductor, who is no dawdler. Both soprano and orchestra tie into things with great abandon, and Miss Pauly does admirably by the text; her rendition of the line "Ach, ich habe deinen Mund geküsst" is splendidly repulsive. The entire scene has fine qualities of mania and slithery eroticism—it isn't pretty, but it's compelling.

For the rest, I must admit I find the early Strauss songs with orchestra boring, except as glances at what the composer had in store for the soprano voice. The extracts from *Die Aegyptische Helena* are interesting, and contain the disc's best vocalism; isn't it time for a complete recording of this opera, along with *Die schweigsame Frau*, *Der Liebe der Danae*, and *Daphne*? (Answer: yes.) The sound is variable. The songs and the *Aegyptische Helena* excerpts are satisfactory, and two of the three *Elektra* excerpts fairly well forward, but the third ("Was bluten muss?") is rather dim. The *Salome* scene is cut off before the soldiers have had their whack at the young lady. C.L.O.

**Landmarks of American Music Series**

**HOW CAN YOU TELL IF A WORK IS A CLASSIC?**

Only by getting to know it through many hearings. Vanguard, in conjunction with West Projects, Inc., is presenting a series of recordings of American works major in scope. In their collective judgment these are good to listen to and important contributions. They are performed with understanding and dedication. Given the opportunity to be repeatedly heard, they may enshrine themselves in people's hearts as the now familiar works of past ages have done.

**Forthcoming**

VIRGIL THOMSON: SUITES FROM "THE RIVER"; "THE PLOUGH THAT BROKE THE PLAINS." Leopold Stokowski conducting the Symphony of the Air.

Prices—Monaural, \$4.98 & Stereolab, \$5.95



The new Vanguard catalogue is off the press, listing full contents of all Vanguard and Bach Guild recordings. Send for your free copy. VANGUARD RECORDING SOCIETY, INC., 154 West 14th Street, New York 11, N. Y.



ROY HARRIS: FOLKSONG SYMPHONY. 1940. Vladimir Golschmann conducting the American Festival Chorus and Orchestra.

VRS-1064 & \*VSD-2082

"Something like the American continent rising up and saying hello." Herberl Elwell, *Cleveland Plain Dealer*

ERNEST BLOCH: AMERICA—AN EPIC RHAPSODY. Leopold Stokowski conducting the Symphony of the Air and American Concert Choir.

VRS-1056 & \*VSD-2055

"A performance seldom matched by Leopold Stokowski in his long and illustrious career... *Kolodin, Sat. Review*. "He makes the Civil War seem real... brings this national tragedy close to our hearts." R. Sabin, *Musical America*.

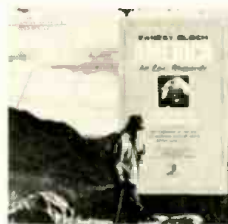

REBEKAH HARKNESS: BARCELONA SUITE. GIFT OF THE MAGI. Sylvan Levin conducting Symphony Orch.

VRS-1058 & \*VSD-2071

"In *Girl's Dance* (from *Gift of the Magi*) she produces her warmest and loveliest piece, composed boldly but with refinement." John Thornton, *HiFi/Stereo Review*.

Just released

SAMUEL BARBER: SECOND ESSAY FOR ORCHESTRA; MUSIC FOR A SCENE FROM SHELLEY; A STOPWATCH AND AN ORDONANCE MAP; SERENADE FOR STRINGS; A HAND OF BRIDGE—CHAMBER OPERA. Vladimir Golschmann conducting the Symphony of the Air; DeCormier Chorale; Patricia Neway, Eunice Alberts, William Lewis and Philip Maero, soloists.

VRS-1065 & \*VSD-2083



GIAN CARLO MENOTTI: CONCERTO IN F FOR PIANO AND ORCHESTRA. AARON COPLAND: CONCERTO FOR PIANO AND ORCHESTRA. Earl Wild, piano, with the Symphony of the Air, Jorge Mester and Aaron Copland, conductors.

VRS-1070 & \*VSD-2094

WEST PROJECTS INC.

TCHAIKOVSKY: *Concerto for Violin and Orchestra, in D, Op. 35; Melody in E flat, Op. 42, No. 3*

Tosy Spivakovsky, violin; London Symphony Orchestra. Walter Goehr, cond.  
 • EVEREST 6049. LP. \$3.98.  
 • • EVEREST SDBR 3049. SD. \$4.98.

Spivakovsky's interpretative ideas are rather unorthodox here. He breaks phase lines into small fragments, employing a great deal of staccato bowing, with over-precious results that interrupt the natural lyrical flow of the music, and make the Concerto sound even more difficult than it is. After all, this is a finely woven fabric; there is no need to show us the seams. Furthermore, since Spivakovsky has a big, firm tone, it was unnecessary for the Everest engineers to put him right in the listener's lap with ultra-close-up microphone placement. Evidently following the lead of his soloist, the late Walter Goehr has also used rather fussy phrasing. The first two movements are presented complete, but the usual cuts are observed in the finale. Good versions are those by Grumiaux, Heifetz, and Stern. P.A.

TCHAIKOVSKY: *Symphony No. 4, in F minor, Op. 36*

Orchestre des Concerts de Symphonique de Vienne, Pierre Kaufmann, cond.  
 • ROULETTE R 75006. LP. \$4.98.  
 • • ROULETTE SR 75006. SD. \$5.98.

A combination of spaciousness and animation marks this highly acceptable performance. It lacks almost all subtlety—in fact, much of the string phrasing in the second movement is unnecessarily underlined—but the playing is quite clean and correct. Reproduction is full-bodied and, in the stereo version, nicely distributed. P.A.

CIRCLE 125 ON READER-SERVICE CARD

**VIVALDI: Concertos: for Bassoon and Strings, in F, P. 305; for Strings, in D minor, P. 86 ("Madrigalesco"); for Woodwinds, Violin, and Continuo, P. 204 ("La Pastorella"). Sonata for Two Violins and Continuo, in B flat**

New York Sinfonietta, Max Goberman, cond.

• • LIBRARY OF RECORDED MASTERPIECES. Vol. 1. No. 7. SD. \$8.50 on subscription, \$10 nonsubscription.

If I am not mistaken, none of these works is otherwise available in the domestic catalogues. The Bassoon Concerto, played with skill and excellent intonation by Leonard Sharrow, and the Sonata seem to me to be fair, run-of-the-mill Vivaldi. *La Pastorella*, which is not a concerto but a quartet with continuo, is distinguished by two peppy fast movements, the first a bucolic piece which features a flute and a bassoon, and the other a tarantellalike dance with an effective pedal point near the end. The prize of this group is P. 86, a string-orchestra piece in the church sonata pattern (slow-fast-slow-fast), which is relatively uncommon in Vivaldi's concertos. Goberman and his able players turn in their usual fine performances, and the sound is very good. As always in this series, the scores are included. N.B.

**VIVALDI: Concertos for Two Violins and Orchestra: in D minor, P. 281; in C minor, P. 436; in G minor, P. 366; in D, P. 189**

Isaac Stern, David Oistrakh, violins; Members of the Philadelphia Orchestra, Eugene Ormandy, cond.

• COLUMBIA ML 5604. LP. \$4.98.  
• COLUMBIA MS 6204. SD. \$5.98.

The first time these artists—Stern, Oistrakh, Ormandy, and the Philadelphia Orchestra—joined forces to record a double concerto by Vivaldi was about five years ago. On that occasion they used a highly edited score that departed drastically from the original, a fact deplored in these pages and no doubt elsewhere too. This time they have gone to the Collected Edition, the best available, and they stick to it faithfully. The result is first-class playing in four works which I believe are not otherwise available on discs. Each of them has points of interest, but I was especially impressed by the lovely and songful opening movement of P. 436 and its energetic finale, the expressive slow movement of P. 281, and the jolly, busy first movement of P. 189. The two soloists, who switch positions from concerto to concerto, are so well matched that I couldn't tell which was which without looking at the label. After a rather tense beginning, the orchestra settles down and companions the soloists beautifully.

These works are of course ideal for stereo: it is a particular joy to hear the sounds of the one violinist coming at you from the left and that of the other from the right. The mono recording is excellent too. N.B.

**WAGNER: Der fliegende Holländer**

Marianne Schech (s), Senta: Sieglinde Wagner (c), Mary; Rudolf Schock (t), Erik; Fritz Wunderlich (t), The Steersman; Dietrich Fischer-Dieskau (b), The

Dutchman; Gottlob Frick (bs), Daland. Chorus and Orchestra of the German State Opera (Berlin), Franz Konwitschny, cond.

• ANGEL 3616 C/L. Three LP. \$14.94.  
• • ANGEL S 3616 C/L. Three SD. \$17.94.

Considering the relative infrequency of *Der fliegende Holländer's* opera house appearance, it has received most generous treatment on discs. This is the fourth complete version to appear since the advent of LP, and a fifth is in the offing. The performances I have seen in the theatre have always caught and held the audience. So much of the music is immediately accessible: the mighty overture, the Steersman's song, Senta's ballad, the Spinning Chorus, the "Italian" arias for Daland and Erik, the moving

duet for the Dutchman and Senta, and of course the wonderful sailors' choruses. And the dramatic material is sure-fire. My own experience (I do not suppose it is typical) has brought me to a somewhat peculiar pass vis-à-vis this opera: I find that these Italianate, "un-Wagnerian" aspects of the work hold up extremely well, while the more dramatic portions tend to become tiresome. The problem is in part purely musical, for the thematic material is stretched a bit thin; the Dutchman's own theme, for example, after being given a thorough workout in the overture, turns up again when his ship is sighted, recurs throughout his opening narrative, appears again during Senta's ballad, and so on until the end of the opera. It is a strong, unforgettable motif, and for this reason alone I am not sure it ought to be thrust into prominence

## VANGUARD recordings for the connoisseur

### HAIL THE VIRTUOSO!

There is no music lover who does not at some time sit back and relish the sheer delight of hearing a virtuoso perform. Whether the marvels of tone and skill are applied to the greatest of music, or offer a relaxation from weightier matters, a virtuoso performance gives us the unfading thrill of discovering what the human body, breath and fingers can do. And from the Baroque to the Romantic era, each period has its own concept of the virtuoso style.



**BERLIOZ: SYMPHONIE FANTASTIQUE.** Vladimir Golschmann conducting the Vienna State Opera Orchestra.  
SRV-120 & SRV-120SD

A Vanguard Demonstration Disc — \$1.98 Monaural and \$2.98 Stereolab.

On Golschmann's demo disc of the Brahms 4th Symphony, the San Francisco Chronicle reported, "Golschmann's trenchant sensitivity of reading and a sound quality of which Vanguard is obviously proud, would justify this album's issuance no matter what it sold for."

#### Forthcoming

**THE VIRTUOSO HARPSICORD: SELECTED WORKS OF RAMEAU.** Anton Heiller, harpsichord. BC-614

Of Heiller's recording of Handel's First Book of Harpsichord Suites, complete, B. H. Haggin wrote in *The New Republic*, "All are played superbly — with enlivening rhythm, inflection and variety of tone."

Prices—Monaural, \$4.98 & Stereolab, \$5.95, except as otherwise noted.

Our new catalogue is off the press, listing full contents of all Vanguard and Bach Guild recordings. Send for your free copy.

VANGUARD RECORDING SOCIETY, INC.  
154 West 14th Street,  
New York City 11, N. Y.



**MISCHA ELMAN** plays *Caprice Viennois*, and other Kreisler favorites.  
VRS-1066 & VSD-2084

Of Elman's Jubilee Record, Irving Kolodin wrote in the *Saturday Review*, "What other violinist would apply Elman's kind of care to every note and nuance . . . The results throughout are merely marvelous."

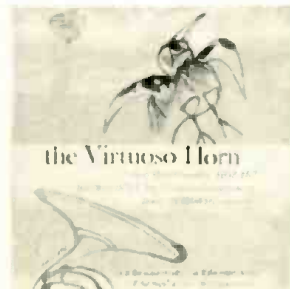

**THE VIRTUOSO HORN: THE FOUR HORN CONCERTOS OF MOZART.** Introducing Albert Linder, with the Vienna State Opera Orchestra under Hans Swarowsky.  
VRS-1069 & VSD-2092

London review on Linder: "The execution was infallible, the phrasing of themes in the classical tradition. A great ovation was given to the Danish musician."



**DELLER'S CHORDS.** Works of Cipriano de Rore, Viadana, Schutz, Locke, Purcell, Blow, Weldon, Handel, Froberger and others. Alfred Deller, counter-tenor, with Gustav Leonhardt, harpsichord and organ. BC-612 & BGS-5038

"A great artist and a distinguished musical scholar . . . an unforgettable experience of beauty . . . *Musical America*, on Alfred Deller.



**THE VIRTUOSO BAND.** Sousa, Alford and other famous marches, and "Soloists on Parade." The Royal Artillery Band, Major S. V. Hays, director.  
VRS-9087 & VSD-2093

On "The Queen's Birthday Salute" recording by the Royal Artillery Band, *High Fidelity* wrote, "One of the most breathtaking sonic spectacles ever achieved."

CIRCLE 126 ON READER-SERVICE CARD

every time the Dutchman speaks, appears, or is mentioned or thought of. One is also aware that the subjects of alienation and redemption were treated by Wagner in a much more profound way in his later operas, with the result that their resolutions here cannot help seeming slightly crude in comparison. No matter; it is still an immensely appealing work, and when given a willing performance, it is gripping and poignant.

The present version is quite expert, and I wish only that it had a more uninhibited, less intellectualized quality at some key points. Prime interest naturally focuses on Fischer-Dieskau's portrayal of the title role. The baritone is in excellent vocal condition (I have never heard him when he was not), and while his darkening voice is still a bit light in timbre for the part, any exception to his

singing as such would be pure quibble. His customary textual comprehension is also very much in evidence; the trouble is, he seems determined to do all our comprehending, too. Is it necessary to lend such heavy emphasis to the words "Satans Tücke" in "Wie aus der Ferne," or to make every hard consonant the occasion for a small dental explosion? "Wie aus der Ferne" is just where Fischer-Dieskau ought, by rights, to leave the competition in the dust, but his overburdened reading is, for me, surpassed by the much simpler "bel canto" renditions of Schorr or Janssen, and in the succeeding duet with Senta he makes himself obtrusive at precisely the point where baritone and soprano should meet and blend. To be sure, he has many fine moments, and in his farewell lines manages to let himself go to the point where

he sings several pages without premeditatedly transfixing every syllable—here he looms very large.

The rest of the cast is unusually capable. Marianne Schech here has a role more suited to her abilities than the Marschallin, and after a few precarious moments in the ballad, sings freely and feelingly—an affecting performance. Gottlob Frick does not give us much clue as to just who or what Daland is, but his voice is such an imposing instrument that it doesn't matter—certainly no other bass now active can sing the Wagner roles as well as he. Both tenors are up to their assignments; Schock sounds a bit bottled up, but nevertheless sings firmly and stylishly, and Wunderlich does his song meltingly. Sieglinde Wagner brings a sumptuous contralto to Mary's lines. Konwitschny's reading, thorough and well planned, is not very rousing; he captures most of the work's domestic warmth, if not enough of the tempest. The Berlin orchestra plays extremely well, and the chorus fills its substantial assignment superbly. The recording is not of the let's-make-a-stage-performance school, and brings us few theatrical effects, but the sound has good dimension and clarity.

The only other available version which challenges this one is London's, taken from Bayreuth performances. It captures some of Astrid Varnay's very best work, and has the gusto of live performance; most collectors will probably prefer the better sound and more consistent casting of the new edition. Decca's entry is quite well recorded, but indifferently sung, and the Urania set, which offered Clemens Krauss and Hans Hotter but little else, is no longer available. Those not panting for a new recording, though, might await RCA's release. C.L.O.

#### WAGNER: *Tristan und Isolde*

Birgit Nilsson (s), Isolde; Regina Resnik (ms), Brangäne; Fritz Uhl (t), Tristan; Ernst Kozub (t), Melot; Waldemar Kmentt (t), Young Sailor; Peter Klein (t), Shepherd; Thomas Krause (b), Kurwenal; Arnold van Mill (bs), King Marke; Theodor Kirschbichler (bs), Steersman. Singverein der Gesellschaft der Musikfreunde; Vienna Philharmonic Orchestra, Georg Solti, cond.

• LONDON A 4506. Five LP. \$23.90.  
•• LONDON OSA 1502. Five SD. \$28.90.

For a feature review of this album, see page 89.

#### RECITALS AND MISCELLANY

#### JACOB AVSHALOMOV: "Works for a Young People's Orchestra"

Harris: *Elegy and Dance*. Diamond: *The World of Paul Klee*. Bergsma: *Chameleon Variations*. Lees: *Prologue, Capriccio, and Epilogue*.

Portland Junior Symphony, Jacob Avshalomov, cond.  
• COMPOSERS RECORDINGS CRI 140. LP. \$5.95.

The Portland Junior Symphony is, with considerable justice, the best-known



take Fine Music with you...WHEREVER YOU GO!

# SONY® TFM-121

RESEARCH MAKES THE DIFFERENCE

## FM/AM PORTABLE ALL-TRANSISTOR RADIO

If you want to enjoy FM and AM indoors and outdoors... listen to this SONY All-Transistor Portable at your favorite dealer. Note the instant signal the same second the set is turned on... the quick power surge when the volume is turned up... the velvet ease of tuning... the remarkable sensitivity that picks up even remote signals without shading, fading or drifting. You'll be pleased with the new SONY dimensions in distortion-free sound... so fine, it can also be used as a tuner. Make this portable your constant companion for music, news and weather. Complete with batteries, earphone and leather carrying case. **\$99.95**

**FEATURES:** 12 transistors • 3 self-contained telescopic antennas (Ferrite bar for AM-dipole for FM) • two step tone control • built-in jack for earphone or for extension speaker • Operates on 4 flashlight batteries • Weighs only 3 lbs. • Size: 5 1/8" high, 9 1/4" wide and 2 1/4" deep

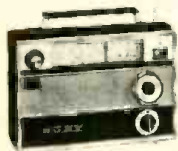

**SONY TR 812**... 3-Band, All-Transistor Portable. Perfect dependability, durability and stability in a superbly designed radio for boat owners, travellers and radiophiles who expect the matchless performance for which all SONY products are famous. **FEATURES:** AM, SHORT WAVE (6 to 18 mc) & MARINE BANDS (2 to 6 mc.). Telescopic antenna. Pinpoint frequency tuning • instant power warm-up • weighs only 5 pounds. Size only 10 1/4 x 7 1/4 x 3 3/8 inches. Complete with batteries. **\$99.95**

At radio centers in your community or write Dept. HF for name of your nearest store

**SONY CORP. OF AMERICA** 514 BROADWAY, NEW YORK 12, N. Y.

Civil Defense recommends a battery-operated radio in every home. Every SONY radio clearly shows the two Conelrad frequencies.

CIRCLE 112 ON READER-SERVICE CARD



Thrilling new release...

# Birgit Nilsson

in

# TRISTAN

UND

# ISOLDE

complete

conducted by

# Georg Solti

with

Fritz Uhl, Regina Resnik, Tom Krause, Arnold Von Mill, Ernst Kozub, Peter Klein, Waldemar Kmentt, Theodor Kirschbichler, Vienna Philharmonic Orchestra and Singverein der Gesellschaft der Musikfreunde

Stereo: OSA 1502 Mono: A 4506



youth orchestra on the West Coast; it is, indeed, even better known than the adult Portland Symphony, with which it has no connection. Some years ago it received a grant from the Rockefeller Foundation to commission a series of works written especially for youth orchestras, and it presents four of them here.

The Diamond is a tricky piece and not a very good one; in trying to suggest the atmospheres of four paintings by Klee, Diamond creates a tissue of odd sonorities with little substance. The other three works, however, are very fine indeed, and they resemble each other in one important particular: all are breezy, strong, and ebullient in character, as if Harris, Bergsma, and Lees were especially pleased to be writing for young people and convinced that music of brilliance and enthusiasm is especially appropriate for them. Although all these pieces are supposed to be easier on the players than works written for adult orchestras, none of the four composers writes down to his interpreters, and you would never know that they had borne technical limitations in mind.

It would be an exaggeration to say that the Portland Junior Symphony sounds like an adult orchestra; it sounds like what it is—a highly superior youth orchestra—and under the circumstances that is all to the good. The recording is quite passable. A.F.

## MATTIA BATTISTINI: *Recital*

Rossini: *Il Barbiere di Siviglia: Largo al factotum.* Rubinstein: *The Demon: No. non plorar.* Tchaikovsky: *Eugen Onegin: Se dell'Imen.* Verdi: *Un Ballo in maschera: Eri tu. Ernani: Vieni meco.* La Traviata: *Di provenza il mar.* Don Carlo: *Per me giunto; O Carlo, ascolta.* La Forza del destino: *Urna fatale.* Donizetti: *La Favorita: A tanto amor; Vien, Leonora.* Bellini: *I Puritani: Bel sogno beato.*

Mattia Battistini, baritone.

• ANGEL COLH 116. LP. \$5.98.

Perhaps more than any other singer, it is Battistini who has preserved for us the concept of opera as a singer's art. To him, the opera that did not offer singers ample room for embroidery and interpolation was merely an inartistic encumbrance, and the conductor or director who would interfere with the process an annoying, if insignificant, parasite. He had a point, and he brings it home again and again on his recordings, for his ability to color and gild while spinning an almost endless line was more expressive than all the parlando declamation we will hear in a season's operagoing. We must admit that singers with less than perfect control of their mechanisms may as well not try it, and that the approach is suitable only for some music, though this singer's elegance and brilliance served him as well for Onegin as it did for Carlo V.

His low notes were weak, and he shied away from them whenever possible (as in "Eri tu"), but the polished ease and ringing strength of his work in the upper range was unparalleled. He is at his very greatest in the Bellini and Donizetti arias presented here, where his sunny tone rolls forward with thrilling freedom, and his technical command is absolute. Those who would contend that

ffrr  
mono

LONDON  
RECORDS

ffss  
stereo

Write for free catalog: Dept. KA, LONDON RECORDS, INC., 539 W. 25 St., N. Y. C.  
CIRCLE 76 ON READER-SERVICE CARD

his treatment of words was sloppy, or his regard for their meanings indifferent, are counseled to listen to his rendition of Rodrigo's death. The final selection—the cavatina and cabaletta from *Forza*—represents recording done when Battistini was in his late sixties (we must remember, too, that young Battistini was never recorded); the voice is somewhat slower and thicker than in the earlier selections, but still steady and gleaming, and he sails through the cabaletta with power to spare. The *Traviata* and *Ballo* arias are somewhat truncated, and the "*Largo al factotum*" goes at a perfectly unbelievable clip—this is, however, the speed of the original recording, and not a mistake in transfer.

The sound is remarkably good, and the album is embellished with Angel's usual careful notes and texts. One should

not forget, however, the earlier Eterna releases, which contain much splendid material not included here, and one should keep in mind that some of this singer's best recordings are not yet on LP (the "*Ah, non mi videste*" from *Werther* is an example—Massenet transcribed the score so that Battistini could sing the tenor role, and his interpretation of the aria is uniquely beautiful). But this is a commendable release, and should not be passed up. C.L.O.

**JUSSI BJOERLING:** "*The Beloved Bjoerling: Vol. 1*"

Bizet: *Carmen: La fleur que tu m'avais jetée*. Donizetti: *L'Elisir d'amore: Una furtiva lagrima*. Meyerbeer: *L'Africana: O Paradiso*. Massenet: *Manon: Le Rêve*;

*Ah, fuyez, douce image*. Puccini: *Manon Lescaut: Donna non vidi mai! La Bohème: Che gelida manina*. Turandot: *Nessun dorma*. Mascagni: *Cavalleria rusticana: O Lola, bianca come fior*. Cilea: *L'Arlesiana: E la solita storia*. Ponchielli: *La Gioconda: Cielo e mar*. Verdi: *Rigoletto: Questa o quella*. Leoncavallo: *Pagliacci: Vesti la giubba*.

Jussi Bjoerling, tenor; Stockholm Concert Association Orchestra, Nils Grevillius, cond.

• CAPITOL G 7239. LP. \$4.98.

It is altogether proper that a wide selection of Bjoerling's recordings be repressed for LP, and the present record, the first of three volumes, offers some of the tenor's best operatic discs. It is extremely unlikely that we will hear "*Che gelida manina*," or the two *Manon* arias, or "*Nessun dorma*" sung as well in the next twenty years as they are sung on this recording. The only performance not quite up to the usual Bjoerling standard is his overly open, rather strained "*Lamento*" from *L'Arlesiana*; it might have made way for "*Salut! demeure*," the early "*Di quella pira*," or some other example of peak-condition Bjoerling.

Regrettably, most of the arias in these transfers cannot be compared for presence with the 78s from which they were taken, and some conspicuously artificial reverberation hardly helps matters. The best sung excerpts are the most disappointing, for the excitement of the originals is simply not present here. The climax of "*Nessun dorma*" does not pop out at the listener as it did; the "*Che gelida*" and "*Fuyez, douce image*" have little of the richness or brilliance that characterized the originals. Let us hope that better results are obtained with succeeding volumes. C.L.O.

**ALFRED DELLER:** "*A Musical Panorama of Shakespeare's England*"

Alfred Deller, countertenor; Deller Consort.

• VANGUARD BG 606. LP. \$4.98.

A generous and cleverly varied nose-gay of Elizabethan and Jacobean music, these pieces vary in character from a clown's song to a sacred motet. The media they employ range from a solo lute to a five- or six-part vocal ensemble. The composers include such masters as Dowland, Wilbye, Tallis, Morley, and Byrd; among the anonymous works are such favorites as *Greensleeves*, the charming *Have you seen but a whyte Lillie grow*, and *Lord Rendall*, as well as the famous *Agincourt Song*, the only piece here not likely to have been heard in Shakespeare's England, since its musical setting would have been considered hopelessly old-fashioned. One suspects, on the other hand, that the lovely harmonies in Desmond Dupré's lute accompaniment to *Lord Rendall* stem from a considerably later date than the period in question. But these are small points that distract in no way from the musical, literary, and historical interest of this well-performed and well-recorded collection. N.B.

**GREAT VIOLINISTS OF THE NINETEENTH AND TWENTIETH CENTURIES**

Pablo de Sarasate, Leopold Auer, Joseph



any way you listen to it ...

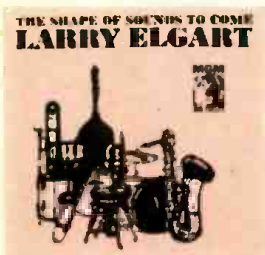

The shape of sounds to come — NOW! E/SE3896



Roger Mozian's brass is always greener, si? E/SE3920



The son—in sound—of BEN-HUR... E/SE3900



Hear how live Latin sounds by Mozian can be... E/SE3921

Some hi-fi folks claim the only way to hear the ultimate in sound is to listen through earphones. Ummm, perhaps... but our motto is live and let listen. To each his own. One thing we are certain about: these new MGM spectaculars will make your ears stand up and take notice. Didn't just happen—we planned it that way. So listen to 'em any way you like. A word to the wise: play 'em with caution—might be habit-forming, you know.



**MGM RECORDS** Hi-Fi Mono or Super Stereo THE STARPOWER LABEL

CIRCLE 77 ON READER-SERVICE CARD

Joachim, Eugene Ysaÿe, Jan Kubelik, violins; piano.

• ASCO A 123. LP. \$3.98.

As it did with its reissues of great pianists of this and the last decade, the American Stereophonic Corporation has again gone back to the past, this time to come up with turn-of-the-century discs by five great violinists.

An entire LP side is devoted to performances by Sarasate, mostly of his own music. Among the very earliest disc recordings made by a renowned violinist, these reveal the Spanish virtuoso as a performer with a silken-sweet tone and a good deal of interpretative fire. There are a few carelessly played passages, but these are unimportant. Far more important is the carelessness of the present producers, who have included the same recordings of the Tarantella and Habanera twice by mistake, and have cut off the first part of the *Zigeunerweisen* before it was finished.

Auer's recordings of Brahms's *Hungarian Dance* No. 1, in G minor, and of Tchaikovsky's *Mélodie* were made in 1920, when he was seventy-five, yet he displays a big, fat tone and an amazingly secure technique. Joachim was almost as old when he faced a reproducing horn during the first years of this century. By then, his technique was far from perfect, but the style with which he invests his own arrangements of two Brahms *Hungarian Dances* is remarkable for its virility and true gypsy flair. Ysaÿe's tone—heard here in works by Vieuxtemps, Wieniawski, and Brahms—is large and warm, and he employs a considerable amount of rubato, though he keeps it well within musical bounds. Kubelik, whose single recording here was made in 1902, when he was at the height of his powers, gives a flashing account of Bazzini's *Ronde des Lutins*.

Asco deserves a big vote of thanks for making this disc available. It deserves another vote for the unusually high quality of the sound, extricated as it must have been from underneath a heavy overlay of surface noise, nearly all of which has been eliminated. Aside from the miscues in the Sarasate works already mentioned, this is a memorable release. May it have many sequels. P.A.

#### I MUSICI: "Serata napoletana"

A. Scarlatti: *Concerto grosso No. 3*, in F. Leo: *Concerto for Cello and Strings*, in D. Durante: *Concerto for Strings*, in F minor. Pergolesi: *Concerto for Flute and Strings*, in G.

Enzo Altobelli, cello; Severino Gazeloni, flute; I Musici.

• Epic LC 3760. LP. \$4.98.  
• Epic BC 1119. SD. \$5.98.

Although all of these works are already available on microgroove, they are far from hackneyed, and it is good to have them on one disc in these competent performances. All were written in the first half of the eighteenth century by composers who worked in Naples, and so "Neapolitan Soirée" is a suitable title for the collection. To me all but the Pergolesi are well worth rehearing. The orchestral concerto by Scarlatti is a cheerful, lively work with a fine Largo and an interesting fugue. An attractive fugue is a feature of Leo's lovely work

too. The Durante has the greatest specific gravity of the group: it generates a considerable amount of tension in the first two sections and the finale, and for relaxation there is a flowing *Amoroso*. Very good sound in both the mono and stereo versions. N.B.

#### DANIEL POLLACK: *Piano Recital*

Daniel Pollack, piano.  
• MK-ARTIA 1548. LP. \$5.98.

Mr. Pollack's playing in this recital of pieces by Bach, Beethoven, Chopin, Liszt, and Paganini-Liszt-Busoni is characterized by a neutral temperament. The lack of precision and focus is evident in many facets of the playing: the pianist's rhythmic sense lacks exactitude (as wit-

ness his run-through of the *Winter Wind* étude), his phrase contours are vaguely drawn and tensionless, and the tonal shading—all mezzo forte in dynamic intensity—becomes monotonous. That Mr. Pollack has competence and facile fingers is shown by the performance of *La Campanella*, which is tossed off with considerable aplomb. Conversely, not once does he succeed in placing the reiterated *subito piano* in the opening movement of the Beethoven Op. 79 Sonata on the first beat where it belongs. It is distressing to find an obvious professional like Pollack falling into this kind of pitfall. H.G.

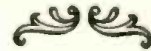

**SOPHISTICATED!**

special sounds for special people...

YOU are special. How do we know? Simple. The very fact that you're reading THIS ad in THIS magazine proves you've got an acute case of special interest. Interest in music. Interest in sound. Interest in new ideas in listening. That's where MGM comes in. You see before you a group of new albums we know are very special. They're not for everybody. How could they be? We made 'em for YOU.



Hi-Fi Mono or Super Stereo

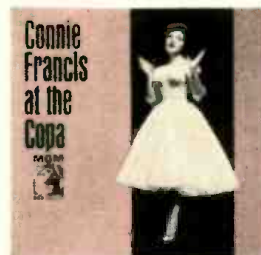

Number One singer—Number One nitery. Magic! E/SE3913



An Off-Broadway long-running smash... E/SE38720C



Lush, velvety version of a great score... E/SE3916



Andre... cool, comfortable, swinging... E/SE3908

THE STARPOWER LABEL **MGM RECORDS**

CIRCLE 78 ON READER-SERVICE CARD

# The Lighter Side



POPULAR • THEATRE • FOLK

## Sixteen Years After—and Spanking Fresh

*"On the Town."* Nancy Walker, Betty Comden, Adolph Green, John Reardon, Cris Alexander; Orchestra, Leonard Bernstein, cond. Columbia OL 5540, \$4.98 (LP); OS 2028, \$5.98 (SD).



*Singers Walker, Green, and Comden with composer-conductor Bernstein.*

IT IS SIXTEEN YEARS since *On the Town*, a jazzy, rollicking, slam-bang musical, rolled into New York one browned-out December evening, to light up the Adelphi Theatre and the whole of West 54th Street. For a very respectable 463 performances it continued to convulse Broadway audiences, then closed, cherished as one of the more memorable musicals of the war years. With record companies not yet interested in backing musicals with an eye to producing original cast recordings, *On the Town* expired, except for a small remembrance from Decca in the form of a 78-album of six songs, sung by Comden, Green, and Nancy Walker of the original cast, with Mary Martin added, presumably to

boost the album's sales appeal. This disc is still available as Decca DL 8030.

The genesis of *On the Town* was Leonard Bernstein's fantastically successful ballet *Fancy Free*. The task of expanding this into a full-length musical was entrusted to the team of Comden and Green, then appearing at The Village Vanguard as part of a night club act called The Revuers. Naturally, Bernstein had to write additional ballet music and vocal numbers. In a field entirely new to him, his complete score—with its wealth of melody, its intensely rhythmic dance numbers, and its integration of all the elements essential to a musical comedy—represents one of the great achievements in the American mu-

sical theatre. Jerome Robbins was called in to do the choreography, a job he had performed for *Fancy Free*, and the old wizard, George Abbott, was inveigled into directing. Authors and lyricists Comden and Green joined Nancy Walker, John Battles, and Cris Alexander as members of the cast, which also included the beautiful Sono Osato in the non-speaking role of Ivy.

In this spanking re-creation of the original production, no less than four members of the original cast have been corraled for their original roles. The one newcomer is John Reardon, who takes over the part played by John Battles. Sixteen years is a long time, but not only do the music and lyrics sound as fresh today as they did then, but, marvel to say, the cast sound not one day older than they did in 1946. As the taxi driver proud of her talents as a chef and a charmer, Nancy Walker is as devastating as ever in *I Can Cook Too*, and equally funny trying to induce a reluctant gob to *Come up to My Place*. In *Carried Away*, Comden and Green give vent

to their suppressed desires with almost stentorian vigor, though both are considerably more subdued in the couplets of *Some Other Time*. The haunting *Lonely Town*, one of Bernstein's loveliest ballads (and this from a composer who isn't supposed to be able to write ballads) is beautifully handled by John Reardon, who does an equally good job on *Lucky To Be Me*. The real strength of the score, however, remains its ballet sequences, with their superb picturization of the excitement and the loneliness that can characterize New York. With Bernstein conducting, these are assured definitive performances, which is exactly what they get.

Originally *On the Town* was an unusually long score, and for recording purposes two numbers, *Do-Do-Re-Do* and *I Understand*, have been excised completely, and the chorus number that introduces the night club scene, *So Long, Baby*, has been slightly cut. With so many wonderful numbers recorded, it is doubtful that any of the deletions will be missed. J.F.I.

---

## Sonic Innovations in Sound-Effects Discs

"Jets: Sounds of American Air Defense";  
"Racing Cars: Famous Mercedes-Benz Cars, 1937-55."  
*Riverside XK 8001, XK 8003, \$5.98 each (Two SD).*



*Grauer of Riverside.*

PICKING UP the torch which E. D. Nunn of Audiophile Records once kindled so brightly in Saukville, Wisconsin, Bill Grauer of Riverside Records is the latest aspirant to leadership in the search for disc recording-and-processing qualities indistinguishable from those of a master tape. Although his new "Fortissimo" series with its handsome double-folder packaging and elaborately detailed annotations follows a current vogue and although his engineers seem to have utilized orthodox enough equipment (if with more than ordinary care and skill), the records themselves boast at least two really radical features: the grooves progress *outward* from the disc center (after the fashion of the history-making ERPI "broadcast transcriptions" of two or more decades ago), and the red vinyl material of which they are made embodies a "Polymax" additive claimed to have exceptional hardening and lubricative properties and to be able to effectively eliminate static.

Without prolonged use it would be risky to attempt definitive evaluations or predict the likelihood of these innovations being widely adopted. Yet even on first encounter it is evident that in stretch of dynamic range, in freedom from distortion and surface noise, and above all in immaculate crispness of sonic definition and transient response these discs mark a measurable new advance in technical excellence. Just how much of this can be made aurally perceptible is, of course, strictly dependent on the playback equipment's own capabilities.

Certainly the series boldly dares trial by the severest of sonic test materials in the present two sound-effects documentary programs. Many fine jet-plane takeoff, pass-by, and sonic-boom recordings have been made before now, but none I know ranges as widely or achieves as sensational a degree of dramatic realism as these candid sound shots of everyday activities at the Eglin Air Force Base in Florida—featuring F-100-series jets, but also

representing prop planes, a helicopter, and an extremely vivid control-tower scena. The racing car release is somewhat less spectacular, as well as shorter (only one disc side is used), but its synthetically combined race of the famous Mercedes-Benz W-125, W-163, W-165, W-196, and 300-SRL contains a formidable variety of car sounds quite exciting in themselves as well as of high historical interest to *aficionados*.

In both discs the wide yet seamless stereo spread and specificity of source locations and movements

add distinctively to the fabulously high fidelity. Two additional "Fortissimo" releases (a "mighty Wurlitzer" George M. Cohan recital by Paul Renard, XK 8002, and "Hoopla! Banjo Polkas" by "Uncle John" Cali and his Keilbasi Six, XK 8004—both novelty programs originally released monophonically as Riverside RLP 845/46) may attract audiophile attention for their technical qualities, but from my point of view it is rather a pity to see such superb engineering techniques so foolishly wasted on inconsequential materials. R.D.D.



Bettmann Archive

### Steam Locomotives, "Lovingly Immortalized"

**"Whistles in the Woods (This is Railroading, Vol. 3)."**  
*Kistler SK 105/6, \$4.98 (LP). "Whistling Thru Dixie."*  
*Mobile Fidelity MF 6, \$3.98 (SD). "Reading 2124: Sounds of Trains in Motion." North Jersey Recordings 1135, \$4.95; 1135, \$5.95 (SD). "Detroit Division: An Anthology of Grand Trunk Western Steam Locomotives." Roundhouse WLP 9839, \$4.95 (LP). "Remember When? . . ." Mobile Fidelity MF 5/M, \$3.98 (LP).*

EXCEPT for fanatical railroad veterans and buffs, most discophiles have probably paid scant attention to the passionate endeavors of several obscure recording companies to preserve (before it is forever too late) what may be the most memory-haunting sounds of the America of yesterday—those of the steam locomotives which once dominated the continent's travel ways. Until recently I myself had been only mildly interested in the few such documentaries that chanced my way, but listening to the present examples, I found myself not only succumbing to their nostalgic magic but infected with an evangelical fervor to bring their potent evocations to the ears of everyone who once thrilled to the real thing.

Surprisingly, the motion-illusion capabilities of stereo are far less vital here than might reasonably be expected. They do enhance the thundering-by episodes in two of the present releases, but their absence detracts little, if at all, from the atmospheric authenticity—or even the vividness—of the monophonic recordings, the best of which primarily exploit the illusions of distance and nearness rather than those of strictly lateral movement and precise sound-source locations. Some of the most effective examples merely imply a generalized sense of motion via microphones mounted in or on the trains themselves, but in any case it is the choice of materials rather than the specific techniques used which determines the validity here.

Some of the present collections will be relished best by buffs, particularly the "Reading 2124" program, most of which was recorded on "Iron-Horse" club "rambles" and filming runs in Pennsylvania and New Jersey, and the "Remember When?" anthology of short highlights from earlier Mobile Fidelity programs representing a wide variety of roads and engine types. Others are of special regional interest: "Whistles in the Woods" of the work-locomotives of Pacific Northwest logging companies; "Whistling Thru Dixie" of the Deep South backwoods lines; "Detroit Division" of both freight and commuter lines in Michigan. But in all of them the old steamers are lovingly immortalized, in jacket photographs and annotations as well as in their own distinctively individual brazen voices.

This alone would ensure their value as Americana. Their best moments, notably those in "Whistling Thru Dixie" but most often and magically in "Whistles in the Woods," preserve something else—which holds and haunts one. I have never been in the Pacific Northwest, but the Kistler disc's inexpressibly poignant reëchoing whistling, now barely overheard in the far distance, now thrillingly close at hand, stirs me even more than my actual memories of the Boston & Albany suburban trains I once knew. Like other incomparable experiences records have given us, those here wholly baffle verbal description or analysis. They can only be *felt* for oneself. R.D.D.

**"Carefree."** Percy Faith and His Orchestra. Columbia CL 1560, \$3.98 (LP); CS 8360. \$4.98 (SD).

With much more variety, animation, and musical interest than most mood-music albums, this program might better be described as a concert of light music, and excellent light music at that. For years one of the most resourceful arrangers of other people's music, Faith does an equally handsome job here with twelve pieces of his own composition. There are so many fascinating numbers that I am unable to decide whether I prefer *Brazilian Sleigh Bells*, a brilliant evocation of a Rio Street carnival, to *Goin' Home Train*, with its unusual and insistent rhythmic pulse; or that I enjoy the complicated cross rhythms and delightful half-improvisatory opening piano theme of *Carefree* more than the gaily spirited and tuneful *Go-Go-Po-Go*. I think most listeners will be faced with the same sort of problem. Some of these pieces have appeared on earlier Faith recordings, but this is the first album to be devoted entirely to his music. The sound is brilliant throughout, with some stunning effects achieved on the stereo version. J.F.I.

**"The Giants of Flamenco: Montoya and Sabicas."** ABC-Paramount ABC 357, \$3.98 (LP).

For lovers of flamenco, few things could be more desirable than a recording bringing together the virtuoso talents of Montoya and Sabicas. Seemingly determined to outdo each other in this program of their own compositions in flamenco vein, these guitarists soar here to new heights. One can only marvel at the brilliant technique, the masterful control and dexterity of fingers. At the same time, one is caught up in the intensity of feeling conveyed—the fiery excitement and passion, the pensive sadness and aching lament. A wholly memorable performance. O.B.B.

**"Frederick Fennell Conducts Victor Herbert."** Mercury PPS 2007, \$4.98 (LP); PPS 6007, \$5.98 (SD).

Apart from a fine Mantovani disc for RCA Victor last fall, Herbert's operetta favorites have benefited little from stereo so far. Now Fennell, his forty-four-man orchestra, and ultradaring Mercury engineers go all out to demonstrate how vigorously the familiar old tunes can be rejuvenated. Herbert's ghost may be shocked by some of the fancier Richard Hayman arrangements here, but even he could hardly fail to relish the brilliant ingenuities in the elaborations on *The March of the Toys*, *Romany Life*, and *Habanera*, or the expert solo passages by Sylvan Shulman (violin), Laura Newell (harp), and Bernie Glow (trumpet). And he surely would be impressed by the prodigious frequency and dynamic ranges of the "perfect-presence" recording here, perhaps excessively sharp-edged in monophony, but magnificently expansive in the stereo edition—a real thriller even among today's spectaculars. R.D.D.

**"For the Young at Heart."** Perry Como; Mitchell Ayres and His Orchestra. RCA Victor LPM 2343, \$3.98 (LP); LSP 2343, \$4.98 (SD).

Perry Como's carefully casual way with pop songs has seldom been displayed to better advantage than in this recording of a dozen paeans in praise of, or con-

**For those who love *live* music!**



The SR-445A AM/FM stereo tuner is one of the finest tuners available. It is designed for music lovers who are determined to carry the orchestra—harp, horn and bassoon—out of the concert hall into their own homes. Here is a superb AM circuit that closely matches the sensitive wideband FM circuit for truly smooth and superb stereo realism. And here, in addition to unequalled performance, is decorator-styled beauty. Suggested list price \$139.95.

*For the sheer joy of listening... "There is nothing finer than a Stromberg-Carlson"*

**STROMBERG-CARLSON**  
A DIVISION OF **GENERAL DYNAMICS**

Write for full line component catalog to: Stromberg-Carlson, Box AJ, 1404 N. Goodman St., Rochester 3, N. Y. Tune in "Special Report" Saturday afternoons immediately following the Metropolitan Opera broadcast.

**CIRCLE 115 ON READER-SERVICE CARD**

cerned with, youth. The singer's natural stylishness, his warm voice, and the easy gentle Como beat suit these songs to perfection, and even manage to delude the listener into thinking that the inferior numbers (yes, there are a couple) are the equal of their companions. But Como has been doing this sort of thing for years, so it is hardly a surprising achievement. The ever dependable Mitchell Ayres Orchestra comes up with its customary excellent backing, and the sound leaves nothing to be desired. For the Como fan, a must. J.F.I.

**"Down in the Valley."** The Gateway Singers, M-G-M E 3905, \$3.98 (LP). Like most other *volkstümlich* balladeers of today, the Gateway quartet isn't much concerned about the authenticity of its materials, many of which are frankly

popularized. Nevertheless, its members sing and accompany themselves with such obvious sincerity and relish, as well as an avoidance of spurious sophistication, that they can be genuinely moving at their best (as in the solo versions of *Down in the Mines*, *Times Are Getting Hard*, and *Go 'Way from My Window*) and attractively spirited in *Wade in the Valley* and *Apples, Peaches, and Cherries*. The closely miked recording is boldly realistic except for some quite superfluous echo-chambering in the otherwise attractively sonorous Calypso song *Kingston Market*. R.D.D.

**"Heavenly Violins of Brazil."** Lyrio Panicali and His Violins, Epic LF 18006, \$3.98 (LP); BF 19006, \$4.98 (SD). With the intention of exploring the possibilities of the violin section of his

orchestra, Lyrio Panicali offers a group of original arrangements of Brazilian melodies. His efforts are well rewarded. Complemented by fascinating rhythms from the rest of the orchestra and the use of native instruments of Brazil, the string section emerges brilliantly colored and exciting. Maestro Panicali would have done well to limit himself to Brazilian tunes, however—*Liebestraum* does not lend itself to this kind of orchestration. Of the two versions, stereo offers cleaner, brighter sound. O.B.B.

**"As Time Goes By."** Vera Lynn; Williams Singers; Geoff Love and His Orchestra, M-G-M E 3889, \$3.98 (LP). I'm not absolutely certain as to when I first heard Vera Lynn, but it must have been before the War—and well before she had become "The Sweetheart of the Forces" (English Forces, of course). I thought her then, as I do now, one of the most completely satisfying of all girl singers. A warm, comforting voice, a completely unaffected vocal style, perfect diction, and unusual sincerity enabled her to tackle almost any kind of song, although the slow, smoldering ballad was perhaps her forte. All these admirable qualities are still apparent in this new album. Although Miss Lynn's versions of *It's Easy To Remember* and *As Time Goes By* genuinely tug at the heart, it is perhaps invidious to single out individual songs from a program so consistently well sung. Contributing to the general pleasure of this album are the admirable backings of the Geoff Love Orchestra, and the quality of the sound, which appears to be of English derivation and is very fine. J.F.I.

**"Gene Estes."** Gene Estes, vibraphone; ensemble, Carlton STLP 12/125, \$4.98 (SD).

Don't be scared off by the ballyhoo of the subtitle, "The Greatest Stereo Vibraphone in Recording History." Estes is a virtuoso who brings taste as well as skill to his own solos and who not only gives his talented sidemen (particularly John Bainbridge on bass clarinet) ample opportunities to shine but also infuses the whole ensemble with a group spirit. The music itself has exceptionally jaunty chamber-jazz attractiveness—especially imaginative in Estes own *Califa*, *Imitation Silver*, and *Wind Up*; dashing yet always lilting in the fast *Fascinating Rhythm* and *Crazy Rhythm*. Except for occasional hardness in the too closely miked vibraphone tones, the recording admirably captures both the glitter of these sparkling performances and their stereogenic antiphonies. R.D.D.

**"Music of Kern, Gershwin, Rodgers, Youmans, and Arthur Schwartz."** Milton Rettenberg, piano, Folkways FS 3857, \$5.95 (LP).

One or two rarities in this collection of show tunes by five American composers should make this a record of considerable interest for those who collect musical Americana. Of prime importance are the two Vincent Youmans songs, *Rice and Shoes* from *Two Little Girls in Blue* (1920), and *Keepin' Myself for You*, written for the first film version of *Hit the Deck* (1929). The former is an excellent example of Youmans' melodic invention, the latter is in his more typical vein. Two of the five Gershwin songs may also be relatively unfamiliar: an

GRADO "Truly the world's finest..."

## AN IMPORTANT MESSAGE

We take extreme pride in introducing a new series of electro-dynamic, moving coil stereophonic phonograph cartridges which are destined to completely revolutionize stereo record reproduction.

From these cartridges you the audiophile will realize the softest, smoothest, most effortless sound you have ever heard.

The disastrous distortions due to overcut records, the harsh, strident, plastic resonant type stereo sounds are now a thing of the past.

These cartridges designated "THE CLASSIC SERIES" will track the most violently complex recorded passages put on records, whether they be on the inner or outer grooves.

Your records will assume a clarity of sound and lack of distortion beyond your wildest expectations. The complete lack of surface noise is almost eerie, the tremendous dynamic range and bass response will leave you breathless. The highs have an infinite quality that makes you suspect a somewhat lack of highs until they blossom forth with a smoothness that completely defies comparison. The superb transient separation is such that a dimensional quality is achieved even with solo recordings.

For a most rewarding experience, listen to the truest of all sound the . . .

GRADO CLASSIC SERIES STEREO CARTRIDGE audiophile net \$37.50

CLASSIC LABORATORY SERIES CARTRIDGE audiophile net \$49.50

LABORATORY SERIES TONE ARM \$39.50

For further information write: **GRADO LABORATORIES, INC.**  
4614 Seventh Ave., Brooklyn 20, N. Y. • Export — Simontrice, 25 Warren St., N. Y. C.

CIRCLE 54 ON READER-SERVICE CARD



early effort, *I Was So Young*, written in 1918 and interpolated in the score of *Good Morning Judge*; and *Feeling I'm Falling*, originally sung by Gertrude Lawrence in the ill-fated *Treasure Girl* of 1928.

The least well known of the Kern items is *Nobody Else but Me*, introduced into the 1946 revival of *Show Boat*, after the composer's death. More interesting, perhaps, is Rettenberg's exhumation of the lovely and quite intricate verse for *All the Things You Are*. Originally written as a duet, it is seldom heard these days, and to my knowledge has never been recorded before. All four Rodgers songs are familiar enough, although only one, *There's a Small Hotel*, is among his most popular. Arthur Schwartz is represented by only one song, the beautiful (and by no means obscure) *If There Is Someone Lovelier Than You*.

In almost all cases, Rettenberg plays the verse of each song, a practice now considered rather *démodé*. The performances have a rather informal air about them, as if the pianist were playing for fun and for a few friends, and the arrangements are not overelaborate, although Rettenberg can, when he chooses, introduce some interesting touches. Rhythmically, the performances strike me as being a little wayward; the verse to *Soon*, for instance, is rattled off as if it were the *Minute Waltz*. The Folkways sound gets fuzzy occasionally, but this did not interfere with my enjoyment of an extremely interesting disc. J.F.I.

**"An Evening of Romance with Claudio Villa."** Coral CRL 57317, \$3.98 (LP). Although the market for Italian favorites is fast reaching the saturation point, there should certainly be room for one more if the vocalist is as competent as Claudio Villa. His style is warm and effortless with just the right emotional impact for *Come Prima* and *Arrivederci Roma*. His rendition of *Torero* with a vibrant cha-cha rhythm is thoroughly enjoyable, and he even manages to impart some freshness to *Nel Blu Dipinto Di Blu*. O.B.B.

**"Danube Waves."** Hollywood Bowl Symphony Orchestra, Miklós Rózsa, cond. Capitol SP 8540, \$5.98 (SD). Rózsa's background no doubt colors this lively program of *Mittel-Europa* favorites. Best are his rich *Zigeunerweisen Theme* (with cymbalom) and darkly powerful Liszt *Hungarian Rhapsody No. 14* (in the piano series), both done in Eugene Zador's skillful orchestrations. But he brings incisive vigor, if also occasional brashness, to Ivanovici's title piece and Josef Strauss's *Mein Lebenslauf Waltz* (also in Zador arrangements), Strauss Senior's *Radetzky March*, and Smetana's *Bartered Bride Overture*—all of which are superlatively well recorded in smoothly broad-spread and breezily open stereoism. R.D.D.

**"Giant Hits of the Small Combos."** Recording supervised by Joe "Fingers" Carr. Warner Bros. WS 1406, \$4.98 (SD). The intriguing idea of re-creating in modern sound a dozen recordings of best sellers from the past two decades is attributed here to one Joe "Fingers" Carr, who is actually Lou Busch, one-time a & r man for a major record company, was closely connected with a

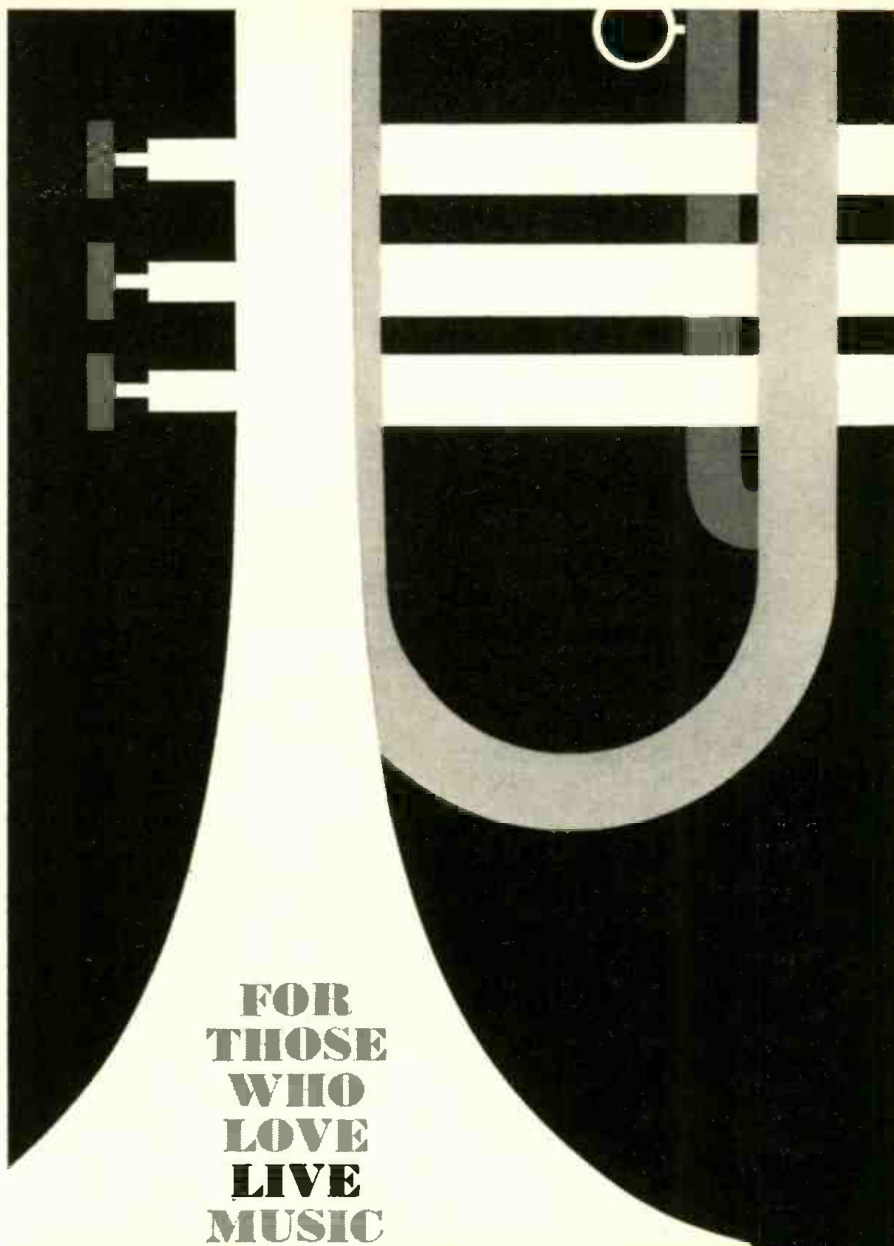

**FOR  
THOSE  
WHO  
LOVE  
LIVE  
MUSIC**

The ASR-660 stereo pre-amp/power amplifier—conservatively rated at 36 watts—offers the ardent music lover the best of two worlds. He gets all the smooth, clean power and flexibility he needs to re-create in his own home the spaciousness and musical warmth of the concert hall. He gets a marvel of engineering ingenuity and customized construction, designed for a lifetime of enjoyment and reliability, at a remarkably attractive \$149.95 (suggested list price).

*For the sheer joy of listening... "There is nothing finer than a Stromberg-Carlson"*

**STROMBERG-CARLSON**  
A DIVISION OF **GENERAL DYNAMICS**

Write for full line component catalog to: Stromberg-Carlson, Box AJ, 1404 N. Goodman St., Rochester 3, N. Y. Tune in "Special Report" Saturday afternoons immediately following the Metropolitan Opera broadcast. **CIRCLE 116 ON READER-SERVICE CARD**

# let's spread the message...

**the joy of listening to music in the comfort of your home.**

Send two or more copies of this Special Tenth Anniversary Issue of High Fidelity where they will count—your high school library, public library, to music students and teachers, audiophiles, friends who share your enjoyment but don't get High Fidelity. And how about sending copies abroad through The President's Music Committee of the People to People Program? Let's show the world some of the cultural benefits of living in the U.S.A.! We'll arrange the distribution for you. By increasing the number of High Fidelity readers you

open the way for us to give you still **more** reviews of new recordings, **more** test reports and background articles on high-fidelity equipment, **more** behind the scenes visits with those who make music. For this purpose we reduce the price of this Tenth Anniversary Issue, mailed anywhere, from 60c a copy, to

**2 copies for only \$1  
(more at the same rate)**

Please send payment with your order. And order quickly—before copies sell out, for this is sure to become a collector's item.

-----  
**HIGH FIDELITY, Box 600, Great Barrington, Mass.**

Please send \_\_\_\_\_ copies of your Tenth Anniversary Issue (April 1961) at the special rate of 2 or more copies at 50c each. I enclose payment in full \$\_\_\_\_\_.

Send one copy to: Name \_\_\_\_\_

Name \_\_\_\_\_ Address \_\_\_\_\_  
City & State \_\_\_\_\_

Address \_\_\_\_\_  
City & State \_\_\_\_\_

Name \_\_\_\_\_  
Address \_\_\_\_\_  
City & State \_\_\_\_\_

Name \_\_\_\_\_ My Name \_\_\_\_\_

Address \_\_\_\_\_ Address \_\_\_\_\_  
City & State \_\_\_\_\_ City & State \_\_\_\_\_

Send \_\_\_\_\_ copies abroad through The President's Music Committee of the People to People Program.

Send me \_\_\_\_\_ extra copies.

★ ★ ★ ★

number of the original recordings. Copying the original arrangements note for note, and using a musical styling identical with that of the original. Busch has produced performances that even the most knowledgeable listener would find difficult to label spurious. Particularly successful duplications here are *Misirlou* (Jan August), *Twilight Time* (The Three Suns), *Begin the Beguine* (Eddie Heywood), and *Peg o' My Heart* (The Harmonicats). The remainder are almost equally faithful to the originals, however, and the whole program is a fascinating one. J.F.I.

"Wildcat." Original Cast Recording. RCA Victor LOC 1060, \$4.98 (LP); LSO 1060, \$5.98 (SD).

*Wildcat* took such a severe drubbing from the New York critics that at this writing its chances of survival seem extremely slim. *Wish You Were Here* however, received a set of similarly adverse notices, yet recovered and went on to be a huge success. If *Wildcat* is as fortunate, the personal popularity of Lucille Ball will be mainly responsible. In this, her Broadway debut, she proves herself a resourceful performer, a delightful comedienne, and a singer who, though not blessed with much of a voice, knows just how to use it to best advantage. She makes her invitation to *Hey, Look Me Over* with a superb feeling of relish for the lyric, as well as for Coleman's ear-catching melody; she suggests the feminine charmer perfectly in *Give a Little Whistle* (which she shares with Keith Andes); and she romps through *What Takes My Fancy* with happy abandon. It is only when Miss Ball turns pensive, as in *That's What I Want for Janie*, that she seems a little ill at ease. Keith Andes, the star's vis-à-vis, unfortunately gets little opportunity to display his fine baritone voice.

Coleman's score is not exactly an outstanding one, but it has three or four numbers that have immediate appeal—better than par for today's musical shows. The orchestrations by Robert Ginzler and Sid Ramin deserve a special word of praise, and both mono and stereo versions have splendid sound, with the latter boasting some of the most expertly managed sonics I have yet heard from any Victor show album. J.F.I.

"The Soviet Army Chorus in Paris."

Alexandrov Song and Dance Ensemble. Artia ALPS 174, \$5.98 (SD).

The Soviet Army Chorus, a skillful group of singers displaying the finest tonal quality and a superb blend of voices, puts its emphasis always on the dramatic. From the gentlest hint of a sustained note to a choral tone that is massive and intense, every dynamic nuance is carefully attended to. Their version of *Meadowlands* is all excitement, *The Partisans' Anthem* is fired with fervor, and their lyrical interpretation of *Soldier Boy, Sing* is sheer loveliness. Russian texts and phonetic transcriptions are provided as well as English translations. Artia's stereo is clear and resonant. O.B.B.

"An Evening at the Café Carlyle."

George Feyer, piano. Cadence CLP 3051, \$3.98 (LP).

After a year's sabbatical from recording studios, that excellent and most satisfying of café pianists, George Feyer, is back

with an interesting program of Broadway show tunes, movie hits, and European favorites. An astutely devised concert, with a little of something for all tastes and ages, it is performed with Feyer's customary showmanship and acute musical perception. Never one to overpower the listener with pianistic pyrotechnics, Feyer achieves his effects with a subtlety and a delicacy, a musical taste that must be the envy of his competitors. On three occasions here, however, the pianist has been permitted to turn vocalist, and, Nat Hentoff's jacket notes to the contrary, the results are something less than successful. Feyer is not a singer; furthermore, his English is poor, his Italian little better, and only his German is passable.

Supposedly, this is a recording of a live performance, in which the habitués of the Café Carlyle were requested to withhold their applause. Seldom can an audience have been more accommodating: they are silent enough to seem not to be there at all. J.F.I.

"Do Re Mi." Original Cast Recording. RCA Victor LOCD 2002, \$5.98 (LP); LSOD 2002, \$6.98 (SD).

I suspect that Jule Styne's score for *Do Re Mi*, though one of his usual workmanlike jobs, may sound a good deal better in the theatre than it does on records. This is definitely a strong "book" show; to implement the complications of the story line, Styne has had to write a number of situation or expository numbers, which no doubt serve their purpose most effectively but which become something of "stage waits" on the record. Nancy Walker's *Waiting, Waiting*; her duet with Phil Silvers, *Take a Job*; and even Silvers' soliloquy *All of My Life* fall into this category.

When he is not bogged down with book problems, Styne has written one or two excellent numbers. *Cry Like the Wind*, a pseudo folk ballad, is particularly lovely, especially as sung by Nancy Dussault. Miss Dussault also scores heavily with an amusing novelty number *What's New at the Zoo*, for which Comden and Green have written ingenious lyrics, and as a wife anxious to allay her husband's fears, she is tremendously effective in *Adventure*. On the whole, however, this extremely talented comedienne has not been given much to work with; and although John Reardon does a fine job with *Make Someone Happy* and *I Know About Love*, neither is a particularly outstanding number. Comedians, of course, are not expected to sing, but Silvers makes a brave attempt to do so and almost pulls it off. He is most amusing in *The Late, Late Show* (a song with a distinctly Jimmy Durante-ish flavor), slightly less funny in *It's Legitimate*.

Styne's music has been brilliantly orchestrated by Luther Henderson, a man who doesn't consider it necessary to blow you out of the theatre to impress you with his skill, and the entire performance is directed with Lehman Engel's invariable snap. The recorded sound is faultless, although the stereo version, for some reason, struck me as being rather static compared with the brilliant stereo version of *Wildcat*. J.F.I.

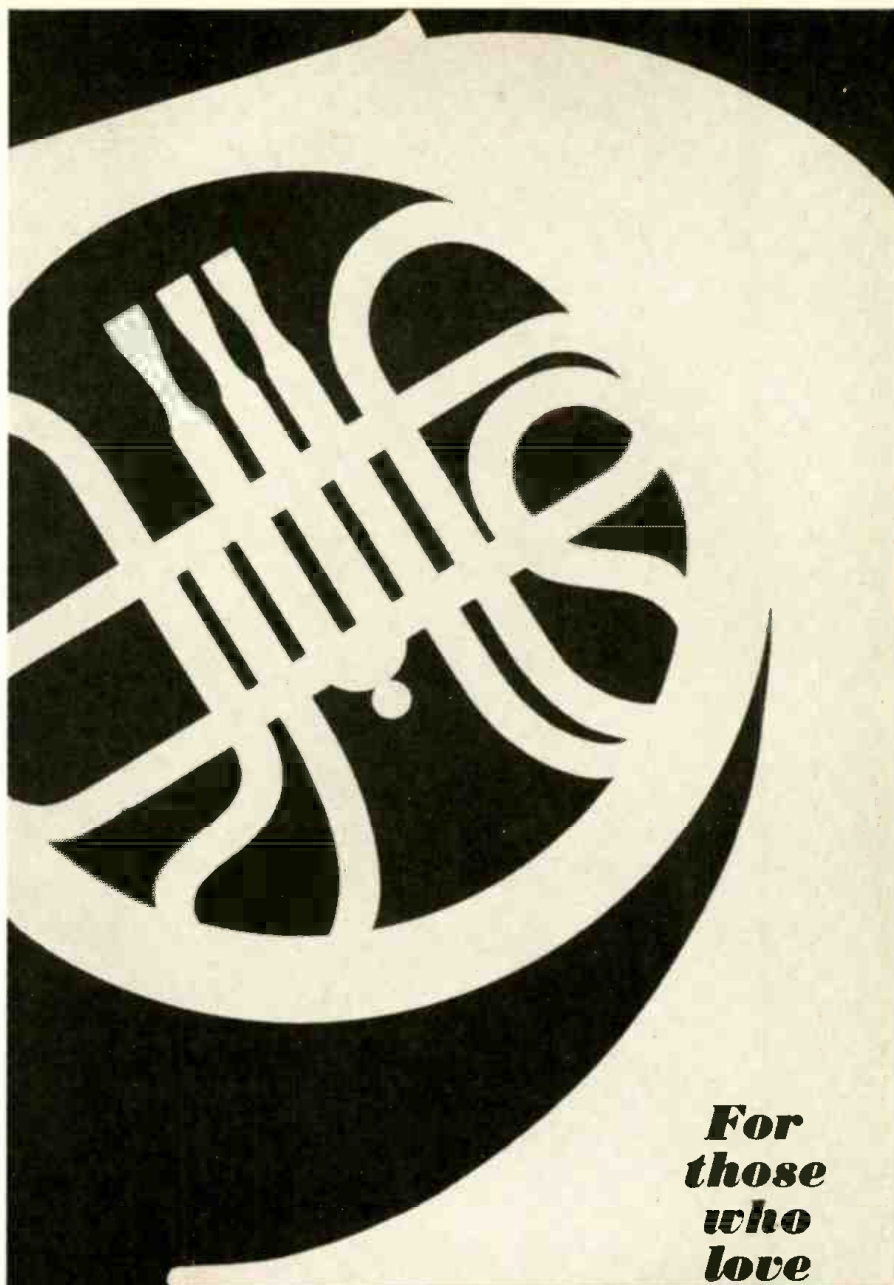

**For  
those  
who  
love  
live  
music**



The RS-504 two-way, high-compliance speaker system is built for music lovers with a feel for what's real—people determined to move the orchestra—lock, stock and kettledrum—into their living rooms. Along with its 12" long-excursion woofer, the RS-504 features a new super tweeter that disperses the high frequencies uniformly throughout the listening area, so that you enjoy full-range, balanced stereo anywhere in the room. Yet the system measures only 15½ x 24 x 14½. \$74.95 (suggested list price). Available in beautiful decorator housings in a variety of finishes.

*For the sheer joy of listening... "There is nothing finer than a Stromberg-Carlson"*

**STROMBERG-CARLSON**  
A DIVISION OF **GENERAL DYNAMICS**

Write for full line component catalog to: Stromberg-Carlson, Box AJ, 1404 N. Goodman St., Rochester 3, N. Y. Tune in "Special Report" Saturday afternoons immediately following the Metropolitan Opera broadcast.

CIRCLE 117 ON READER-SERVICE CARD

# MORE NEW SOUNDS AND GREAT NAMES FROM THE FABULOUS



1. **EYDIE Gorme & STEVE Lawrence • COZY**  
Intimate music styling in a new, true and accurate sound concept almost beyond imagination—with no tricks, no gimmicks, to detract from the basic premise of good music.  
WWS 8509 (Stereo) WW 7509 (Monaural)
2. **FERRANTE and TEICHER • GOLDEN PIANO HITS**  
Striking interpretations of best-selling hits played in the tantalizing style of this brilliant piano team, with full, rich orchestral background, give new expression to famous melodies.  
WWS 8505 (Stereo) WW 7505 (Monaural)
3. **TITO RODRIGUEZ • MOTION PICTURE THEMES CHA CHA CHA**  
Fascinating arrangements of themes from famous motion pictures expressed in exciting Latin American rhythm, produce colorful new listening and dancing pleasures.  
WWS 8507 (Stereo) WW 7507 (Monaural)
4. **SAUTER-FINEGAN • The Return of the DOODLETOWN FIFERS**  
Unorthodox instrumentations produce the unusual sounds pioneered by this veteran team of arrangers turned orchestra leaders, bringing you brilliant listening sensations.  
WWS 8511 (Stereo) WW 7511 (Monaural)
5. **RALPH MARGERIE • 88 STRINGS**  
Fantastic arrangements combine lush strings and augmented brass and reed sections with the human voice—all led by the golden trumpet of Ralph Margerie—for sparkling new musical excitement.  
WWS 8506 (Stereo) WW 7506 (Monaural)

ALSO AVAILABLE IN THE NEW  
DELUXE COMPACT PACKAGE  
(Monaural Only) at \$3.98

## OTHER ULTRA AUDIO RELEASES

- TERRY SNYDER & the ALL STARS • MISTER PERCUSSION**  
WWS 8500 (Stereo) WW 7500 (Monaural)
- DON COSTA • ECHOING VOICES AND TROMBONES**  
WWS 8501 (Stereo) WW 7501 (Monaural)
- NICK PERITO • BLAZING LATIN BRASS**  
WWS 8502 (Stereo) WW 7502 (Monaural)
- AL CAIOLA • GUITARS, WOODWINDS & BONGOS**  
WWS 8503 (Stereo) WW 7503 (Monaural)
- FERRANTE and TEICHER • DYNAMIC TWIN PIANOS**  
WWS 8504 (Stereo) WW 7504 (Monaural)



AND WALL TO WALL SOUND . . . MONAURAL

ULTRA AUDIO A product of UNITED ARTISTS RECORDS • 729 7th Avenue • New York 19, N. Y.

CIRCLE 122 ON READER-SERVICE CARD

# JAZZ



**Count Basie and His Orchestra:** "Kansas City Suite." Roulette 52056, \$3.98 (LP); S 52056, \$4.98 (SD).

The ten pieces by Benny Carter in this so-called suite (on the surface, they seem simply to be ten pieces with no particular relationship) provide the Basie band with far better material than it has been getting lately from its regular writers. The arrangements are richly voiced, the performances glistening. The result is a pleasant but not really exciting disc. Yet it is a comment on the dully glib output of the Basie band that even this faint praise is more than one is usually able to muster for what should be—but almost never is—a brilliant jazz band.

**Donald Byrd:** "Byrd in Flight." Blue Note 4048, \$4.98 (LP).

In the past year Byrd has risen from a drab level of playing to become a distinctive and rewarding trumpeter. His tone is now full and warm, and his ideas are developed with skilled directness and a lyricism surprising in one who was schooled in the jazz of the Fifties. His playing here has tremendous strength, but it is the strength of confidence and assertiveness, not of aggressiveness. Alto saxophonist Jackie McLean, heard on three of the six selections, has ripened in much the same manner. Backed by a buoyant rhythm section—Duke Pearson, piano; Lex Humphries, drums; and either Doug Watkins or Reggie Workman, bass—they keep most of these selections at a high pitch of interest.

**John Coltrane:** "Lush Life," Prestige 7188, \$4.98 (LP); "Coltrane Jazz," Atlantic 1354, \$4.98 (LP).

Coltrane's several years of painful public experimentation as he explored the potential of his tenor saxophone have begun to pay off with remarkably cultivated and deeply expressive performances. The title tune on "Lush Life" is an impressively limber, thoughtful, and strongly emotional creation by Coltrane, with challenging addenda by Red Garland, piano, and Donald Byrd, trumpet. Coltrane reveals several of his abilities here. His firm, lyrical lines on a ballad and the sinuous, cutting treatment of a slow blues are extremely effective. But a plunge into his odd "sheets of sound" style quickly becomes monotonous. The Atlantic disc includes his first recording on soprano saxophone—a very tentative sample that does not do justice to the facility he has developed on this instrument. The easy, unforced quality of Coltrane's recent playing is emphasized

throughout this collection, but there are occasional slips into needlessly flat statements of ballad themes.

**Johnny Griffin and Eddie "Lockjaw" Davis Quintet:** "Tough Tenors." Jazzland 31, \$4.98 (LP); 931, \$5.98 (SD).

Griffin and Davis are not really tough in the knotty, uncouth sense usually conveyed by the word. They are extremely virile, sinewy performers who have developed under the decidedly untough influence of Lester Young (to whom they pay a fitting and brilliant tribute by playing Young's *Tickle Toe*). Davis is easily the more interesting of the two. His playing is always tremendously propulsive, couched in lean, biting lines that leap from his tenor saxophone with overwhelming intensity. Griffin's tone is softer and less assertive; while Davis is constantly forging ahead, Griffin is apt to leap back on hack riffs. They are supported by a complementary rhythm section—Junior Mance, piano; Larry Gales, bass; and Ben Riley, drums. In general, this is miles above the usual run of blowing sessions, but a steady diet of two rather similar saxophones eventually becomes tiresome.

**Nancy Harrow:** "Wild Women Don't Have the Blues." Candid 8008, \$4.98 (LP).

With her first recording, Miss Harrow immediately places herself in the forefront of singers moving in the jazz milieu. This is, possibly, not quite so great an achievement as it might seem at first glance because, with two or three notable exceptions, the female of this species is currently quite uninteresting. Miss Harrow stacks up less impressively against singers of earlier generations, but the mere fact that she exists today gives one heart and hope. In fact, one suspects that she may be capable of more consistently good singing than she shows here, for on almost every selection she is more successful on her second appearance (after an instrumental interlude) than on her first. She has an excellent foundation: a flexible voice, sensitivity to dynamics and phrasing, and the shining good taste to stay away from fashionable absurdities. At times, however, she seems unable to sustain the lyrical lift at which she is aiming. The accompaniment is excellent: arrangements by Buck Clayton, who buoys her with his masterful muted trumpet, and provocative surrounding solos by Dickie Wells, Dick Wellstood, Buddy Tate, and the infrequently heard Tom Gwaltney, a

warm, understanding clarinetist who also plays (as one brief solo reveals) alto saxophone with a Woody Herman touch.

**"Jazz of the Forties, Vol. 1." Folkways** FJ 2841, \$5.95 (LP).

These selections from a 1946 concert at Town Hall, New York, erratically recorded, involve a number of brilliant jazz musicians—James P. Johnson, Sidney Bechet, Baby Dodds, Miff Mole, Muggsy Spanier, Pee Wee Russell, and Art Hodes, among others. There are some brilliant performances (fortunately, they suffer the least from the recording): a soaring Bechet attack on *China Boy* highlighted by a fascinating drum solo made up of rim shots by Baby Dodds, some saucy striding by James P. Johnson on *I've Found a New Baby*, ruggedly expressive playing by Spanier and Mole on *Relaxin' at the Touro*, and some unexpectedly gutsy trumpet work by the usually lyrical Johnny Windhurst. Despite its sonic lapses, particularly where large ensembles are involved, this disc is a valuable addition to the work of Dodds, Johnson, and Bechet, all of whom are dead, and Mole, who has been incapacitated for the last decade.

**Lonnie Johnson:** "Blues and Ballads."

Prestige/Bluesville 1011, \$4.98 (LP). Johnson's plaintive, slightly nasal voice is backed in this collection by his own electric guitar, by the unamplified guitar of Elmer Snowden (making his first commercial recording in twenty-six years), and the strong bass of Wendell Marshall. With this sturdy prop and his own assertive phrasing, Johnson gives a group of blues and at least one of three ballads very convincing, affecting interpretations. On *Memories of You*, his approach is gentle and lyrical, and yet his controlled inner tension builds tremendous emotional power. Two other ballads, his own compositions, are too stickily sentimental to be effective. Snowden is a sympathetic accompanist and displays an easy, swingingly graceful style on three guitar duets with Johnson. The whole session has a relaxed quality that must be, at least in part, a distillation of the years of experience of these old pros.

**Yusef Lateef:** "The Centaur and the Phoenix." Riverside 337, \$4.98 (LP); 9337, \$5.98 (SD).

It is characteristic of Yusef Lateef that, no matter how much he may have become involved with exotic instruments (the argol, rabat, earthboard, 7-Up bottle, balloon) or weird pseudo-folk strains,



## The Modern Jazz Quartet

Two brilliant  
new LP packages by the  
world's greatest jazz group!



"EUROPEAN CONCERT" (2-603), a  
double-LP package, is the first "live"  
recording of an MJQ concert.



"THE MODERN JAZZ QUARTET &  
ORCHESTRA" (1359) is a program of  
specially commissioned works with  
large symphony orchestra.



This album, like "THIRD STREAM MUSIC"  
(1345), is a new music, that combines  
classical elements with jazz.



EUROPEAN CONCERT 2-603  
monaural \$9.98 stereo \$11.95

THE MODERN JAZZ QUARTET & ORCHESTRA 1359  
monaural \$4.98 stereo \$5.98

Write for complete LP catalogue and stereo disc listing.  
**ATLANTIC RECORDS**  
1841 Broadway • New York 23, N.Y.

CIRCLE 12 ON READER-SERVICE CARD

his music has always been harnessed to a strong swinging attack. Furthermore, he is constantly developing. Having experimented in one particular area, he assimilates what he values there and moves on to new things. "The Centaur and the Phoenix" offers the most richly developed exposure of Lateef we have yet heard, in (for the first time) a nine-piece band setting. The arrangements (all but one based on originals) are written by Lateef, by Kenneth Barron (a remarkable seventeen-year-old), and by Charles Mills, a contemporary composer attracted to jazz by Lateef's work, and they are refreshingly imaginative and adventurous. Lateef reveals once more the surging muscularity of his tenor saxophone playing, his soaring ideas on flute, and the very swinging sense that he can bring to the oboe. Moreover, he has discovered a bassoonist, Josea Taylor, who fits his instrument quite readily into a jazz format. There are also brief but appealing appearances by Clark Terry on flügelhorn, Richard Williams on trumpet, Curtis Fuller on trombone, and Tate Houston on baritone saxophone.

**Junior Mance:** "The Soulful Piano of Junior Mance." Jazzland 30, \$4.98 (LP); 930, \$5.98 (SD).

The once useful term "soul" has been so misused in jazz parlance lately that Jazzland is doing no favors to so delightful a pianist as Junior Mance by appearing to associate him, in the title, with the cliché-ridden thumpers currently grinding out "soul jazz." Mance lives in a totally different world. His style is essentially light and airy, but he can roam through a blues without changing character or resorting to any pianistically heavy-breathing devices. His ideas are neatly organized, cleanly set out, and presented with refreshing jauntiness. In this he has some kinship with Erroll Garner, but he is not so confined by mannerisms as Garner. This is one of the most engaging collections to be issued in a long time.

**Matty Matlock and the Paducah Patrol:** "Gold Diggers in Dixieland." Warner Bros. B 1374, \$3.98 (LP); WS 1374, \$4.98 (SD).

Say what one will about the superficiality of the Dixielanders recruited from the Hollywood studios, some of them can generate more vitality than the musicians who devote their lives to playing the same old routines over and over again. The material facing Matty Matlock and his cohorts here is not always very useful: it is made up of songs from the series of *Gold Diggers* movies back in the Thirties—*We're in the Money*, *Tip-toe through the Tulips*, *Remember My Forgotten Man*, and *Shadow Waltz*—nostalgic, maybe, but not necessarily suited to jazz. Still, they attack it in crisp, happy style, and whenever Jackie Coon comes in on his mellophone the performances become positively brilliant. Trumpeter John Best also does a great deal to keep the group driving ahead, while Matlock adds some warm-voiced clarinet touches. Any LP with a good supply of Jackie Coon solos is worth having. This disc is studded with them, and it has a lot of ensemble life, too.

**Leroy Parkins and the Yazoo River Jazz Band.** Bethlehem 6047, \$4.98 (LP). There are a few glimpses of brilliance and quite a lot of mediocrity in this

loose-buttoned session. Almost all of the brilliance can be found in the first two selections: *Louisiana*, which has sturdy stomping ensembles led by Johnny Letman's driving trumpet and a good serving of Dick Wellstood's authentically striding piano; and *Tishomingo Blues*, a long and wonderfully soulful (in the proper sense of the word) exploration of the blues taken at a slow and probing pace by Danny Barker on guitar and, later, by Letman, who creates a superbly pungent, biting solo. All too often, however, the band is sloppy (always excepting Wellstood), and there is a good deal of routine singing by Barker. Parkins, the nominal leader, plays serviceable background clarinet and a thin, watery tenor saxophone.

**The Poll Winners:** "Exploring the Scene." Contemporary 3581, \$4.98 (LP).

Barney Kessel, Ray Brown, and Shelly Manne, who comprise the Poll Winners, are a highly integrated threesome even though they play together only on infrequent recording dates. They are listening musicians who play with and for each other, and, as a result, achieve an inter-relationship that is rare in contemporary jazz. This program consists of eight selections written by modern jazzmen, most of which have attained the stature of standards—John Lewis' *The Golden Striker*, Garner's *Misty*, Horace Silver's *Doodlin'*, Neal Hefti's *Li'l Darlin'*, and others. One of the others is Dave Brubeck's *The Duke* which, on the basis of this charming performance and several others, seems likely to keep Brubeck's name alive in jazz longer than will any of his own performances. This selection and Miles Davis' *So What*, highlighted by a fascinating bass-over-guitar passage, are the most rewarding tracks in this polished collection of subdued but swinging jazz. An interesting sidelight is the inclusion of an Ornette Coleman composition, *The Blessing*, which emerges as quite pleasantly comprehensible after the Poll Winners have straightened it out.

**Max Roach Plus Four:** "Moon-Faced and Starry-Eyed." Mercury 20539, \$3.98 (LP); 60215, \$4.98 (SD).

This is an odd potpourri. The disc is, in effect, a sampler—each selection is a solo feature for either Stanley Turrentine, Tommy Turrentine, Julian Priester, Ray Bryant, or singer Abbey Lincoln. Although the musicians involved, with the exception of Bryant, comprise Max Roach's group, they play as an ensemble only when supporting Miss Lincoln. And although Roach is a noted drum soloist and gets top billing, he takes no solos. What emerges from this peculiar bit of planning are a pair of neatly paced, low-keyed piano solos by Bryant, one good demonstration of Stanley Turrentine's growing stature as a tenor saxophonist, and a treatment of *I Concentrate on You* in which Miss Lincoln and the musicians create a sound and feeling that are strikingly close to that of the old Billie Holiday-Teddy Wilson recordings. It might be noted that, for a Max Roach disc, this is uncharacteristically melodic.

**Otis Spann:** "Otis Spann IS the Blues." Candid 8001, \$4.98 (LP).

There's a double debut on this disc: Otis Spann, Muddy Waters' strong-fingered pianist, is heard as a vocalist for the first time (except for his impromptu *Goodbye Newport Blues* on Waters' Chess 1449),

and Robert Lockwood, Jr., a guitarist and singer, appears for the first time on records. Spann has a strong, Mississippi-bred style, and sings with much of the punching emotional projection that he displays on the piano (two of his piano solos are included). But the real discovery is Lockwood, a stepson of the great blues singer of the Thirties, Robert Johnson. Lockwood has something of his stepfather's lusty, shouting style, although (inevitably, one supposes) it is dimmed by a coating of sophistication. Yet he can burst through this veneer to reach a surging intensity on *I Got Rambling on My Mind*. Lockwood and Spann combine in an instrumental accompaniment of Lockwood's singing on *My Daily Wish*—a performance almost ferocious in its controlled intensity.

**Cal Tjader:** "West Side Story." Fantasy 3310, \$4.98 (LP).

Just when it seemed that the idea of doing jazz versions of Broadway scores had been proven pointless, along come Tjader and arranger Clare Fischer with a brilliantly apt treatment of *West Side Story*. Of course, there is a jazz feeling inherent in much of Leonard Bernstein's score (Manny Albam has already taken advantage of this in an earlier album). But Fischer and Tjader have not simply looked at this score and found jazz. They have also seen the other elements that are there—the tenderness of *Maria* and *I Feel Pretty*, for example—and have left them with their soft, melodic trimmings. And they have brought in the Latin rhythms that Tjader uses so frequently with his small groups, adding a spice that is quite appropriate for a story dealing with Puerto Ricans in New York.

The crucial element in this treatment is Fischer's arranging, for a large orchestra of strings, horns, and rhythm instruments: in his perceptive use of strings both for their percussive force and for their richness as he blends them with jazz rhythms and bongos; for the subtle weaving in of Tjader's vibraharp; for the variety he has achieved without sacrificing unity. This is easily the most sensible—and successful—use of jazz yet made in interpreting a show score.

**George Wein and the Storyville Sextet:** "Metronome Presents Jazz at the Modern." Bethlehem 6050, \$4.95 (LP).

The tendency to dismiss George Wein, pianist, simply because he is better known as George Wein, entrepreneur, does less than proper justice to a man who obviously enjoys playing in the traditional and swing idioms, and who has the good taste and good sense not to let his own pleasure spur him to flashy excesses. Wein is a sound, conservative pianist within this area, and the sextet that he leads from time to time is in the best traditions of mainstream jazz. These excerpts from a concert played one summer's evening in 1960 in the gardens of the Museum of Modern Art in New York are soundly conceived, skillfully played, and thoroughly pleasurable performances, notable for the consistently pungent trumpet playing of Shorty Baker, the beautifully bittersweet clarinet of Pee Wee Russell, and the comfortably pulsating rhythm section of Wein, Bill Crow, and Mickey Sheen. Tyree Glenn's habit of exaggerating his plunger mute effects is sometimes disconcerting, but he is a solid ensemble performer.

JOHN S. WILSON

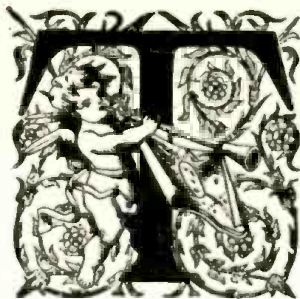

# THE MUSIC OF BROADWAY

in an all-time collection

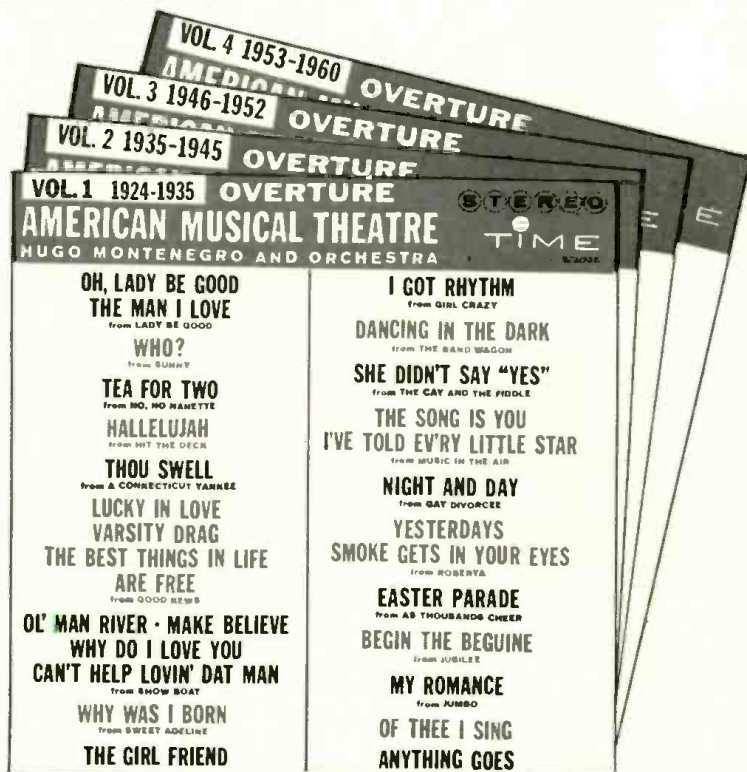

**OVER 115 SONGS ■ OVER 65 SHOWS**

**in 4 Great Albums Recorded  
By Hugo Montenegro with a  
Lavish 70-PIECE ORCHESTRA**

**in the unmatched sound of**

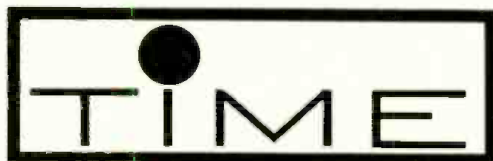

**SERIES 2000**

SONGS LIKE: No Business Like Show Business, Some Enchanted Evening, Old Devil Moon, If I Were a Bell, September Song, Lady is a Tramp, De-Lovely, Small Hotel, Buckle Down Winsocki, Could Have Danced All Night, Just in Time, Everything's Coming Up Roses, Till There Was You, Wunderbar.

FROM SHOWS LIKE: Carousel, Porgy and Bess, Pal Joey, Lady in the Dark, Finian's Rainbow, King and I, Brigadoon, Call Me Madam, Unsinkable Molly Brown, Camelot, Do Re Mi, My Fair Lady, South Pacific, Guys and Dolls.

Send for complete catalogue

**TIME RECORDS INC. 2 West 45 Street, New York, New York**

CIRCLE 121 ON READER-SERVICE CARD



STC-90012

SAINT-SAENS SYMPHONY NO. 3  
IN C MINOR, OP. 78  
Paul Paray Conducting the  
Detroit Symphony Orchestra  
Marcel Dupre, Organist



STB-90043

MUSIC OF LEROY ANDERSON  
Vol. 2, Frederick Fennell Con-  
ducting the Eastman-Rochester  
"Pops" Orchestra



STA-90138

GERSHWIN: RHAPSODY IN BLUE  
CUBAN OVERTURE  
Howard Hanson Conducting the  
Eastman-Rochester Orchestra  
Eugene List, Pianist



STB-90222

POP-OVERS  
Frederick Fennell conducting the  
Eastman-Rochester "Pops"



Now on  
stereo  
tape

CLASSICAL  
JAZZ  
POPULAR

These are a few of the many popu-  
lar albums available on Mercury  
Stereo Tapes. Write today for free  
catalog M-3 of all Mercury Hits!



LET'S DANCE STA-60001  
David Carroll and His Orchestra



STC-60012  
GREAT MOTION PICTURE THEMES  
OF VICTOR YOUNG Hayman

DISTRIBUTED NATIONALLY BY:



**bel canto**

BEL CANTO STEREOPHONIC RECORDINGS

a subsidiary of *Thompson Ramo Wooldridge Inc.*

1977-1985 McAllister Avenue • Columbus, Ohio



STA-60027

DANCE AND STAY YOUNG  
David Carroll and His Orchestra



STA-60028

THE CATS IN STEREO  
The Harmonicats



STB-60068

OLDIES BUT GOODIES  
Griff Williams



STB-60103

CARAMBA!  
Richard Hayman and Orchestra



STB-60152

LET'S DANCE AGAIN  
David Carroll



STC-60162

MORE SONGS FROM GREAT FILMS  
Clebanoff Strings and Orchestra



STG-T1

LET'S DANCE  
LET'S DANCE AGAIN  
David Carroll Twin Pack



STB-80011

DINAH WASHINGTON  
SINGS FATS WALLER

CIRCLE 22 ON READER-SERVICE CARD



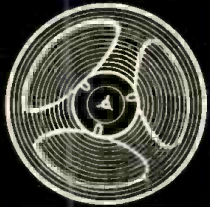

# the Tape Deck

Reviewed by R. D. DARRELL

The following reviews are of 4-track 7.5-ips stereo tapes in normal reel form.

**BEETHOVEN:** *Concertos for Piano and Orchestra: No. 1, in C, Op. 15; No. 2, in B flat, Op. 19; No. 5, in E flat, Op. 73 ("Emperor"). Sonatas for Piano: No. 8, in C minor, Op. 13 ("Pathétique"); No. 14, in C sharp minor, Op. 27, No. 2 ("Moonlight")*

Wilhelm Backhaus, piano; Vienna Philharmonic Orchestra, Hans Schmidt-Isserstedt, cond. (in the Concertos).

• • LONDON LCK 80047-8 (twin-packs). 56 and 67 min. \$11.95 each.

In reviewing the earlier coupling of the Third and Fourth Concertos, I dwelt at some length on the special attractions of this Backhaus series. All the good qualities of that tape are no less evident here: Backhaus' own mellowed but always virile eloquence; the soloist's and conductor's unanimity of interpretative intent; the dynamic equilibrium of sonic weights; and above all the authentic big-hall acoustics, with superbly colored piano and orchestral timbres.

Some Beethovenians may favor a more naively lyrical approach in the delectable First Concerto, but the present treatment reveals more of its usually undisclosed masculinity; and while there are several excellent disc Seconds, I doubt whether any of them is as ideally satisfying in every respect. The *Emperor* is somewhat less outstanding, since for all its breadth and vigor it disdains the bravura excitements of more extroverted performances. Yet (as in the two familiar solo sonatas with which it is coupled in LCK 80048—and indeed in this whole concerto series) the unmannered serenity and strength here reveal substantial new attractions with every rehearing.

**BERLIOZ:** *Grande Messe des Morts, Op. 5 ("Requiem")*

Léopold Simoneau, tenor; New England Conservatory Chorus; Boston Symphony Orchestra, Charles Munch, cond.

• • RCA VICTOR FTC 7000. 83 min. \$14.95.

This release is a notable milestone in 4-track tape history in that it (together with *Trovatore* and *Turandot*) signalizes RCA Victor's acceptance of the new medium for large-scaled works of interest to the connoisseur. The company's policy concerning annotations and librettos for such big works may be distressing to some; the reel box contains a postpaid reply card which must be returned to the manufacturer in order to obtain a copy of the text leaflet—presumably the original booklet which appeared with the disc edition. This has certain advantages over the reduced reprints which other

companies issue with their tapes, but it remains to be seen how tape collectors will evaluate the system.

As for the Requiem itself, the technical splendors of the present recording have been so extensively acclaimed in last year's disc reviews that I need note here only the advantages of the tape medium in maintaining even more subtly differentiated and smoothly broadspread stereoism, and in encompassing with even less strain the fabulous dynamics—ranging from ethereal whispers to apocalyptic thunders—achieved in the present version. In orchestral performance, too, this Bostonian edition is superior to its only serious rival, that by Scherchen. The choral singing, however, has somewhat less assurance and fervency, and Simoneau's excellently controlled tenor solo is not achieved without effort. Interpretatively, Munch is free from the idiosyncrasies that mar Scherchen's reading, yet, for all his restraint and adroit proportioning of the diverse elements that make up this monumental cathedral-in-sound, I miss some of the electrifying urgencies and contemplative breadths of Scherchen at his best. But apart from such slight reservations the Munch performance would have to be ranked as the preferable choice for most listeners, even if the magisterial technology were not irresistible in itself—indisputably one of today's supreme sonic achievements.

**KABALEVSKY:** *The Comedians, Op. 26*

†Khachaturian: *Masquerade Suite*

RCA Victor Symphony Orchestra, Kyril Kondrashin, cond.

• • RCA VICTOR FTC 2028. 33 min. \$8.95.

As in his earlier Rimsky and Tchaikovsky Caprices, Kondrashin demonstrates that even the most gaudy of Russian showpieces need not seem vulgar when they are played by a conductor who genuinely believes in them. His persuasive sincerity endows even the shallow *Masquerade* pieces with some conviction and the more imaginative *Comedians* with real gusto. Muscular and extroverted in comparison with Golschmann's lyricism in the Kabalevsky work, Kondrashin's dashing performance is also more broadly stereoisitic in this extremely full-blooded recording. I haven't faltered in my admiration of the fine Golschmann version, but I'm forced to admit that Kondrashin's may arouse more widespread enthusiasm.

**MOZART:** *Serenade No. 15, in G, K. 525 ("Eine kleine Nachtmusik"); Symphony No. 40, in G minor, K. 550*

Vienna State Opera Orchestra, Sir Adrian Boult, cond.

• • WESTMINSTER WTC 150. 42 min. \$7.95.

Sir Adrian's deftly articulated, unhurried, and highly objective approach to the great G minor Symphony may seem a bit old-fashioned, if not prosaic, to those who have discovered from other conductors the depths of passion and the complexity of tensions concealed beneath the formalities of its eighteenth-century idioms. But it is a pleasure to hear it for once, nowadays, played so straightforwardly, if, alas, without the specified repeats except in the Minuet. Boult's simplicity and complete freedom from mannerism are even more refreshing in the popular Serenade, which is so often either grossly inflated or tossed off with a smirk of disdain, rather than given its full meed of gusto and innocent sentiment. The recording too is lucid and unpretentiously stereoisitic.

**PONCHIELLI:** *La Gioconda*

Anita Cerquetti (s), La Gioconda; Giulietta Simionato (ms), Laura; Franca Sacchi (c), La Cieca; Mario del Monaco (t), Enzo Grimaldo; Ettore Bastianini (b) Barnaba; Cesare Siepi (bs), Alvisio Badoero; Chorus and Orchestra of the Florence May Festival, Gianandrea Gavazzeni, cond.

• • LONDON LOR 90004. Two reels: approx. 83 and 67 min. \$21.95.

*La Gioconda* is an opera which retains its vitality primarily as a vehicle for vocal pyrotechnics, especially in the title role; it is hardly surprising, therefore, that the present performance has been overshadowed by the two others available on stereo discs—one with Milanov and one with Callas. It must be admitted that Cerquetti has a rather small voice and, for all her sweetness, no great dramatic conviction; Del Monaco and Siepi sing rather perfunctorily here, and Franca Sacchi is unsteadier than even her aged characterization calls for. Only Simionato and Bastianini combine notable vocal and dramatic authority. Yet the whole is greater than the sum of its parts, and the musical melodrama unrolls here with surprising effectiveness despite the lack of high distinction in the best-known arias and ensembles. I surmise that the rich orchestral performance, excellent tonal balances, and above all the expansive power and solidity of the stereo recording are mainly responsible for this success. The technical effectiveness is all the more surprising when it is remembered that this recording originally appeared, monophonically, in 1958. Callas and Milanov fans may remain unmoved, but for others there are rewarding excitements here, if all too seldom the special thrills aroused by outstanding vocal virtuosity.

**PROKOFIEV:** *Concerto for Violin and Orchestra, No. 2, in G minor, Op. 63*

†**Mendelssohn:** *Concerto for Violin and Orchestra, in E minor, Op. 64*

Jascha Heifetz, violin; Boston Symphony Orchestra, Charles Munch, cond.

• • RCA VICTOR FTC 2046. 47 min. \$8.95.

Although these fresh takes of two of Heifetz's most famous readings appeared on discs only a little over two years ago, I suspect that the master recordings date considerably farther back. The soloist is much more closely miked than in recent practice, the channel-fusion seems imperfect, and there is some indeterminacy in the sound-source location. No Heifetz devotee will worry much

about all that, but there may be some concern about the nervous tension and high speed with which the Mendelssohn Concerto is played—qualities far more suitable for the Prokofiev Second. But in the latter, Heifetz's incomparable wizard again hypnotizes every listener into the firm conviction that this rhapsodic showpiece is indeed great music.

**RIMSKY-KORSAKOV:** *Scheherazade, Op. 35; Christmas Eve: Suite; Sadko, a Musical Picture, Op. 5; Flight of the Bumble Bee; Dubinushka, Op. 62*

Orchestre de la Société des Concerts du Conservatoire de Paris (in *Scheherazade*); Orchestre de la Suisse Romande; Ernest Ansermet, cond.

• • LONDON LCK 80058 (twin-pack). 82 min. \$11.95.

**STRAVINSKY:** *The Firebird (complete); Pulcinella: Suite; Le Chant du rossignol*

Orchestre de la Suisse Romande, Ernest Ansermet, cond.

• • LONDON LCK 80042 (twin-pack). 87 min. \$11.95.

The first of these oversize reels is an unfortunate exception to the general attractiveness of twin-pack editions. For even to potential purchasers who don't already own a *Scheherazade*, Ansermet's disinterested performance will have scant appeal. As for the balance, however, everything is a delight: the really first-rate *Flight of the Bumble Bee*, the swinging *Dubinushka*, and particularly the entrancing *Christmas Eve Suite*.

The Stravinskian cornucopia is valuable from beginning to end: none of these works is otherwise available on 4-track tape and all of them are very much worthwhile. The complete *Firebird* ballet score, in particular, may well be a revelation to those who know only the familiar suite excerpts. Most commentators tend to belittle the usually omitted "bridge" portions, yet I have found with each rehearing that these passages (particularly the Petrushkian preëchoes in the long section preceding Katschei's *Danse infernale*) not only grow in interest in themselves, but that they are essential to a true understanding of the correct proportions of the work as a whole.

The Chinese tone poem and the Pergolesian suite were given their premiere performances by Ansermet, and he still does them with unique sympathy and distinction. Stravinsky specialists may prefer *The Song of the Nightingale* in the more boldly dramatic Reiner version (once available in a 2-track taping that well warrants reissue) and *Pulcinella* in the composer's own complete monophonic disc edition. But the present performance, besides being the only stereo version available, is one of the most spirited, sparkling, and varicolored of all Ansermet's triumphs. It leaves me with but one regret: that some of the superb Suisse Romande soloists—especially the oboe and French horn players—are not identified by name.

**TELEMANN:** *Concertos: for Oboe and Orchestra: in E minor; in D minor; for Viola and Orchestra, in G; for Violin and Orchestra, in A minor. Sonata a quattro, in A*

André Lardot, oboe; Steffano Passagio, viola; Jelka Krek, violin; Solisti di Zagreb. Antonio Janigro, cond.

• • VANGUARD VTC 1632. 48 min. \$7.95.

Don't be misled by the conventional history book representation of Telemann as a sort of minor league Bach noted mainly as the most prolific composer of all time. The genuine evidence of the powers that commanded admiration in his own day (from Bach, among others) lives on as vitally as ever in his best music—and a whole cross-section of that best is given here in the finest Telemann program I've yet encountered. The recording itself first appeared on discs in 1958, but it still scarcely could be

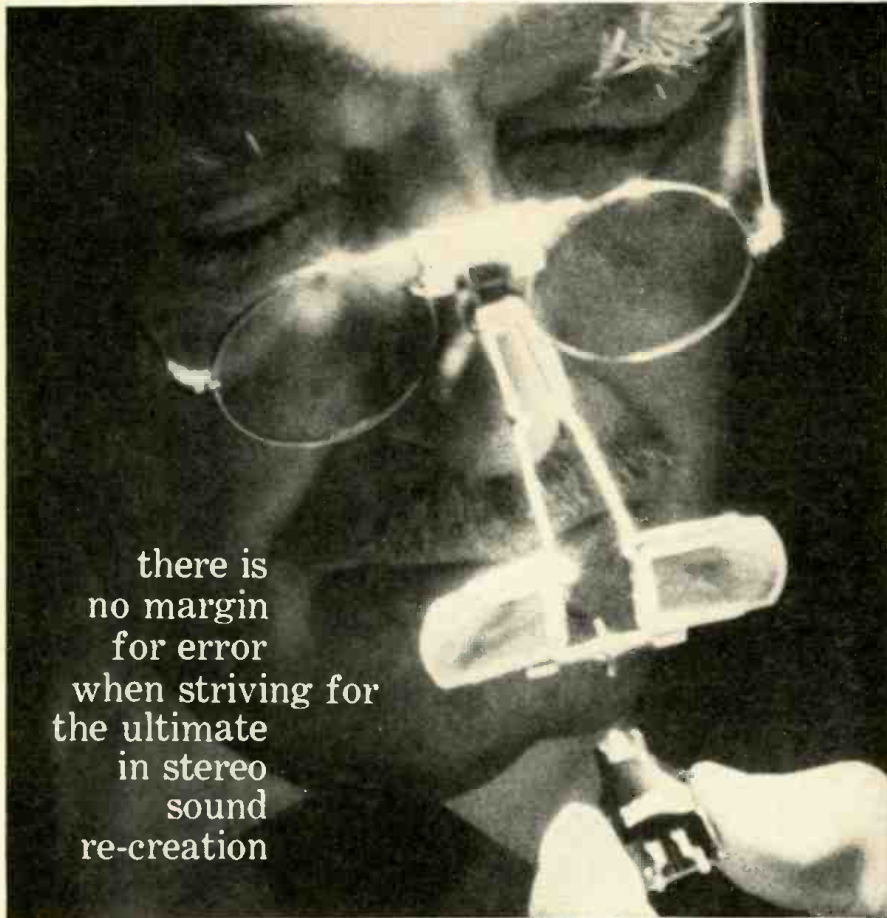

there is  
no margin  
for error  
when striving for  
the ultimate  
in stereo  
sound  
re-creation

**SHURE**

*Stereo Dynamic*

HI-FI PHONO CARTRIDGES

Tiny though it is, the cartridge can make or break a stereo system. For this breathtakingly precise miniaturized electric generator (that's really what it is) carries the full burden of translating the miles-long undulating stereo record groove into usable

electrical impulses... without adding or subtracting a whit from what the recording engineer created. Knowing this keeps Shure quality standards inflexible. Shure Brothers, Inc., 222 Hartrey Avenue, Evanston, Illinois.

**CARTRIDGES**

- Standard M80. A superb blend of quality and economy... \$16.50
- Custom M70 with N210 stylus. Widely acclaimed... \$36.75
- Professional M30 with N210 stylus. Choice of the critics... \$47.25
- Laboratory Standard Model M3LS. Individually calibrated, limited quantity... \$75.00



**TO NE ARMS**

- Studio Dynamic. Integrated arm and cartridge. Cannot scratch records... \$89.50
- Professional Independent Tone Arm. For any quality cartridge stereo or mono... \$29.95



**CIRCLE 109 ON READER-SERVICE CARD**

bettered in its floating and pellucid stereo sonics. The performances, particularly those of the exhilarating oboe concertos, rank high among the many fine ones that Janigro's Solisti have given us. I suspect that relatively few record collectors have been willing to give Telemann and Janigro a chance to speak for themselves, and I can only hope that tape fanciers will be more receptive. For this program is a rewarding revitalization of Telemann's music, and an invitation to look afresh at the whole baroque repertory.

#### VERDI: *Il Trovatore*

Leontyne Price (s), Leonora; Laura Londi (s), Inez; Rosalind Elias (ms), Azucena; Richard Tucker (t), Manrico; Mario Carlin (t), Ruiz; Tommaso Frascati (t), A Messenger; Leonard Warren (b), Di Luna; Giorgio Tozzi (bs), Ferrando; Leonardo Monreale (bs), A Gypsy. Chorus and Orchestra of the Rome Opera, Arturo Basile, cond.  
 • • RCA VICTOR FTC 8000. Two reels: approx. 85 and 36 min. \$21.95.

Coming hard on the heels of the London *Trovatore* last month, this one perhaps profits unduly from the comparison—as well as gains in interest from Miss Price's sensational triumph in her Metropolitan debut in the same work. Since my memory of the famous earlier RCA Victor monophonic disc edition (with Milanov) isn't as vivid as Conrad L. Osborne's (in his October 1960 review of the present version in disc form), I can be more enthusiastic, not only about Miss Price's Leonora, but also about Rosalind Elias' Azucena. In comparison to the routine performances by Monaco and Savarese on London, Richard Tucker's bold (if hardly subtle) Manrico and the late Leonard Warren's somewhat vocally worn but still incomparable Di Luna shine all the brighter. The sound, too, is markedly superior here. Yet even above all these vocal and sonic attractions, a notable distinction of the present performance is the consistently dramatic grip and propulsiveness exerted by its conductor. Basile's galvanic reading generates the genuine excitement that *Il Trovatore* needs if it is not to seem superannuated or merely melodramatic.

#### VAUGHAN WILLIAMS: *Fantasia on a Theme by Tallis; Fantasia on "Greensleeves"; Folk Song Suite*

Vienna State Opera Orchestra, Sir Adrian Boult, cond.  
 • • WESTMINSTER WTC 148. 32 min. \$7.95.

It seems odd that Sir Adrian should have gone to Vienna to remake his justly celebrated readings of Vaughan Williams' most endearing shorter works, but, as it turns out, the venture justifies itself both in the rich warmth of the Austrians' playing and in the conductor's ability to retain the authentic British idioms of the music itself. Needless to say, the antiphonies of the gravely eloquent Tallis Fantasia, with the interplays of string quartet soloists and string choir, might have been written with stereo reproduction specifically in mind. It is magnificently recorded here, as are the light but no less charming *Greensleeves* Fantasia and Gordon Jacob's zestful orchestration of the exuberant folk song suite originally composed for band.

"Americana." Capitol Symphony Orchestra. Carmen Dragon, cond. Capitol ZP 8523, 39 min., \$7.98.

Capitol leads off its second release of 4-track tapes with perhaps the most characteristic of all Carmen Dragon's light symphonic programs. As an arranger he is represented at his imaginatively best in the exhilarating—and dramatically stereophonic—*Dixie*, and at his lushest by inflated but sonically seductive versions of *Battle Hymn of the Republic*, *Home on the Range*, and *Aura Lee*. As a conductor he exploits the full potentialities of his own scores and in addition brings uncommon zest to *The Stars and Stripes Forever*, Copland's *Hoe-Down*, Gould's *Pavanne*, and Grofé's *On the Trail*. All the rich colors are warmly captured.

"The Count Basie Story: Basie Plays Basie." Roulette RTP 520 (twin-pack), 73 min., \$11.95.

No Basie admirer can afford to miss this collection of his greatest hits of the past, here reperformed, mostly in their original arrangements, by his slicker but no less breath-taking band of today. These will never efface the memories of the rougher, wilder originals with the heavily propulsive drive of that incomparable rhythm section, but they sparkle with even more glittering virtuosity and they are, of course, infinitely better recorded in the brightest and most vivid of stereo. As always, I'd like to hear more of Basie himself, who is featured at length only in *Red Bank Boogie*, but his present ensemble has never been more expressive than in *Blue and Sentimental*, more exciting than in *Every Tub*, or more vivacious than in *Live at Five, Doggin' Around*, and *Lester Leaps In*. And for good measure there is also Leonard Feather's valuable illustrated booklet on the fabulous Basie career.



## THIS HYSTERESIS SYNCHRONOUS MOTOR

helps make the 3 SPEED-4 TRACK

RE **Tandberg** SERIES 6

## STEREO TAPE DECK

a remarkable instrument

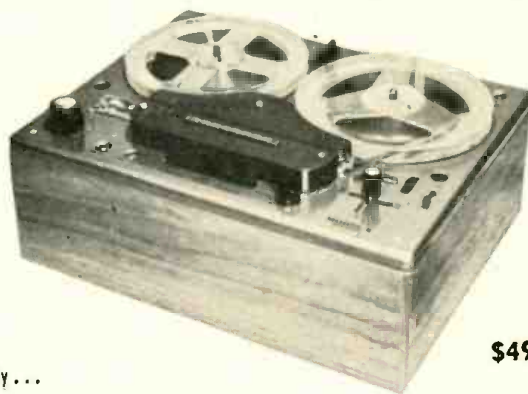

**\$498.00**

Here's why . . .

- Special design makes wow & flutter the least apparent of all quarter-track tape recorders.
- Exhibits high starting torque, attaining proper synchronous motor speed instantly.
- Maintains proper motor speed even though line voltage varies + or - 10% from indicated output.
- Special outside-in construction places moving parts outside core; allows rotor to act as cooling fan.
- Ingenious laminations shield magnetic pole lines from core; virtually eliminating stray magnetic field.

All Tandberg units feature 1 7/8 ips "The Professional's Speed of the Future"

TANDBERG 6 STEREO TAPE DECK ALSO OFFERS THESE OUTSTANDING PERFORMANCE FEATURES:

3 Separate heads for record, playback, erase . . . each gapped for optimum performance; 4 track stereo & monaural record; 4 track and 2 track stereo and monaural playback; Sound-on-Sound; Direct monitor from signal source or active record; Silent pause control; Built-in remote control; Digital counter; Push button operation.

RE **Tandberg** of America, Inc.

8 Third Avenue, Pelham, N. Y.

CIRCLE 118 ON READER-SERVICE CARD

# NEW 1 MIL ACETATE TARZIAN TAPE

Professional Quality

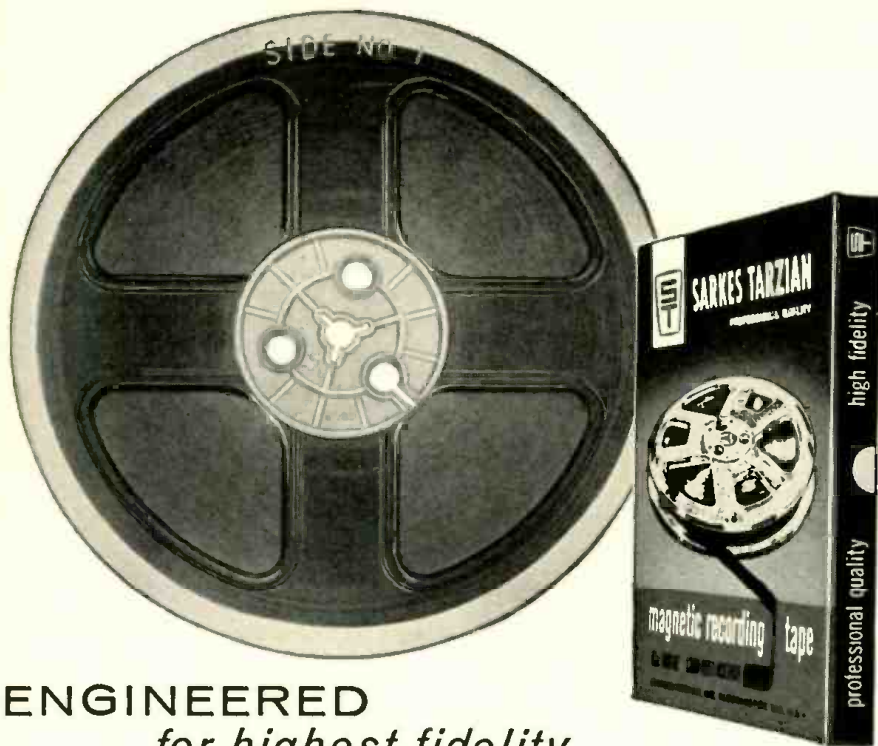

ENGINEERED  
for highest fidelity

- **High Output**—can accept signals with dynamic range to realize the full potential of even the finest professional equipment.
- **Wide-Range Response**—virtually flat response for all recording frequencies.
- **Low Distortion**—distortion is less than 2½% at maximum record level as measured by Navy Specification W-T-0061.
- **High Uniformity**—uniformity within a 1200-foot reel is within plus or minus ¼ db. A new oxide formula and special selectivity of oxides protect recording heads from wear and prevent abrasion.
- **Humidity and Temperature Protection**—special coating, priming, and binding techniques help keep Tarzian tape in new condition longer in ordinary good tape storage conditions.

Now there's another high quality Tarzian Tape—a 1 mil acetate base tape with all the fine qualities of the previously announced 1½ mil acetate tape. You get half again as much tape per reel—900 feet on 5-inch reels and 1800 feet on 7-inch reels—in the attractive, functional Tarzian Tape box.

Tarzian Tape is a quality tape at a low price—developed and manufactured by Sarkes Tarzian, a leader in electronics with an established reputation for maintaining precise high quality in volume production. Consider the quality characteristics of Tarzian Tape listed at left. They assure that audio equipment will sound its best longer... whether it is inexpensive or the most expensive. Prove this to yourself with your personal listening test. There's a written guarantee in every box, and the price is as low as many tapes of much less quality.

Ask your dealer for Tarzian Tape. If he cannot supply you, send us his name, and we will see that your needs are promptly supplied.

*Note to Commercial Users:* Tarzian facilities permit winding special commercial reels and hubs. Your inquiry is invited.



## SARKES TARZIAN, INC.

World's Leading Manufacturers of TV and FM Tuners • Closed Circuit TV Systems • Broadcast Equipment • Air Trimmers • FM Radios • Magnetic Recording Tape • Semiconductor Devices  
**MAGNETIC TAPE DIVISION • BLOOMINGTON, INDIANA**  
 Export: Ad Aurema, Inc., New York  
 CIRCLE 101 ON READER-SERVICE CARD

**"Belafonte Returns to Carnegie Hall."** RCA Victor FTO 6002, 71 min., \$8.95. As in the earlier Carnegie Hall recording, this documentation of the May 2, 1960, gala admirably captures the gusto of the star's responsiveness to the enthusiasm of his large audience. Included here are the lively *Jump Down Spin Around* and *La Bamba*; the comic duos with Odette and Makeba (*A Hole in the Bucket* and *One More Dance*); and the poignantly lyrical *Suzanne* and *I Know Where I'm Going*. Belafonte shares the spotlight liberally with his Folk Singers chorus and with the Chad Mitchell Trio. A few of his own songs are too closely miked, but on the whole the on-the-spot recording conveys the illusion of the listener's being right in the center of the audience.

**"The Blues Hot and Cold."** Bob Brookmeyer Quartet. Verve VSTC 248, 39 min., \$7.95.

One of the best of contemporary jazz trombonists, Brookmeyer displays here not only his originality as improviser and composer (in *Languid Blues* and *Hot and Cold Blues*) but also his extraordinary range of matchlessly colored tonal qualities. While he dominates the performances throughout, his sidemen (Jimmy Rowles on piano, Buddy Clark on bass, and Mel Lewis on traps) contribute distinctive solos of their own as well as vibrant backings for the trombone soliloquies. The stereoism itself is outstanding in the precision with which it pinpoints the sound sources.

**"Camelot."** Original Broadway Cast, Franz Allers, cond. Columbia OQ 344, 52 min., \$9.95. (Also 2-track TOB 100, \$18.95.)

In his last month's review of the disc version of *Camelot*, J. F. Indcox expressed his disagreement with the lukewarm Broadway reviews the show received. In general, I concur with Mr. Indcox. On first hearing *Camelot* does seem to lack any hit songs as immediately captivating as some of the earlier Lerner & Loewe masterpieces—yet *I Loved You Once in Silence* is a truly haunting air, *What Do Simple Folk Do?* and *C'est moi!* are charming for both their lyrics and music, and the all-too-brief orchestral *Parade* is a vivacious delight. And if Julie Andrews (now far more assured than the naïve Liza Doolittle of several years ago) is the only true singer here, sounding even more vocally sweet and limpid than before, Richard Burton and Robert Goulet are notably effective singing actors. What commands my own admiration most consistently, however, is the richly varicolored scoring (with its wealth of such ingenious details as the bagpipe effects in the Knight's Chorus *Fie on Goodness!*) and its sonorous realization by Allers' fine orchestra. The full-blooded stereo sound is unusually good too (and the tape processing irreproachable), but here I would have preferred a more distantly miked technology and big-stage atmosphere even at the expense of some of the present clarity and presence. Yet this is a work of many persuasive appeals and one sure to reveal lasting satisfactions as it becomes better known.

**"The Concert Jazz Band."** Gerry Mulligan and His Orchestra. Verve VSTC 250, 39 min., \$7.95.

This debut of Mulligan's new thirteen-

man band boasts an uncommonly well-varied program which stars Bob Brookmeyer's trombone almost as prominently as Mulligan's own hoarsely eloquent baritone sax. Consistently interesting, the oddly fanciful playing here achieves exceptional originality in the tugging rhythms and antiphonies of *Out of This World*, the complex sonorities of *Manoir de mes rêves* and *Sweet and Low*, and the exuberances of *I'm Gonna Go Fishin'*—all superlatively recorded. An outstanding example of contemporary jazz at its best.

**Delibes: La Source: Selections. Chopin: Les Sylphides.** Paris Conservatory Orchestra, Peter Maag, cond. London LCL 80059, 47 min., \$7.95.

While the Roy Douglas orchestration and Maag's suave performance both stress unduly the *delicatesse*, if not the mawkishness, of *Les Sylphides*, the glowing purity of the stereoism is quite enchanting. And when such sonics are devoted to more spicily vivacious music, in a generous selection from Delibes's seldom heard contributions to *La Source* ballet, the combination is a delicious one indeed.

**"Dynamic Twin Pianos."** Ferrante and Teicher. United Artists UATC 2221, 27 min., \$7.95.

Like most other current spectaculars, this "Ultra Audio" example proves to be considerably more attractive, sonically, on tape than in its more intensely modulated and sharply edged disc version. The channel separation is extreme, but it is appropriate to the duo interplays and responses. The materials and performances themselves are fresher and more amusing (particularly in the two lively originals, *Echo Canyon* and *Alternating Current*) than any I have heard from Ferrante and Teicher since their dramatic first appearances, and the accompanying notes are informative on the "bones, mutes, sticks, and strums" facilitating the duo's tricks with prepared piano and backward-running tape.

**"Stereo Action: Dynamica."** Ray Martin and His Orchestra. RCA Victor FTP 1055, 30 min., \$7.95.

Stock up on Dramamine before tackling this one! Billed as "the sound your eyes can follow," it conveys more vertiginous sensations of motion than even the most extravagantly stereoisitic of recent spectaculars. These are made all the more vivid (not to say *mal-de-mer-ish*) by the engineers' feat in fluidly shifting individual instruments and choirs across solidly stable backgrounds. Happily, the technological virtuosity is also balanced by notably fine orchestral playing and inventive arrangements—almost too ingenious, perhaps, in the hula-shaking *Pagan Love Song*, but breath-taking in a *Flight of the Bumble Bee* and an electrifying *Malagueña*. This remarkable release is convincing evidence that the potentialities of stereo tape for sonic prestidigitation are only just about beginning to be realized!

**"Mr. Percussion."** Terry Snyder and the All-Stars. United Artists USTC 2217, 32 min., \$7.95.

Here is the "Persuasive Percussion" pioneer himself, his allegiance now transferred to the "Ultra Audio" series, but

# Concertone

WORLD'S FINEST TAPE RECORDERS

## The exciting new Series 90 professional tape recorders

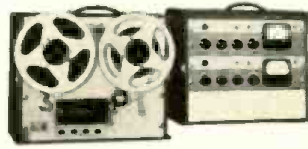

The advanced Series 90, created in the tradition of quality established by the famous Series 30, satisfies the most critical needs of the professional and audiophile. New exclusive Concertone features such as "Edit-o-matic" for high speed tape cueing and editing...exclusive Flutter-Filtering System...combine with the maximum in wide stereo-mono versatility and automatic-remote capabilities...to make the sophisticated Series 90 the most complete and distinguished-performing instrument yet attained. From \$845.

## World famous 505—unequaled stereo performance

The superb Concertone 505 brings you professional reproduction plus unlimited versatility. Available as a 2- or 4-track recorder, and now with exclusive Reverse-O-Matic® permitting 4-track stereo tapes to be played from end to end and back again—unattended. From \$495.



## Transicorder—the DeLuxe miniature tape recorder



"Book size"—all-transistorized—the Concertone Transicorder has big tape recorder features in precision-made miniature form. Lightweight, under 4 lbs., the Transicorder fits in a brief case or glove compartment—yet offers amazing fidelity for on-the-spot recordings anywhere—at home, office or travel. \$169.95.

## New 500 Series—professional quality, modest price

Incorporating today's most advanced recorder design with professional reliability, extreme fidelity and tape-handling ease, the brilliant 500 Series has no equal for flawless broadcast performance or custom installation. 3 silent, heavy-duty hysteresis motors assure maximum timing accuracy, tape stability and years of use. Triple shielded heads afford incomparable sound reproduction. Available as a precision tape player or with separate electronics to be added for mono or stereo record and playback applications—Concertone's new 500 Series is matched only by the costliest instruments. From \$349.50.



At Better Dealers Everywhere

See CONCERTONE

at your dealer. Mail

coupon for

name of nearest

dealer and

complete information.

Dealer inquiries invited.



### AMERICAN CONCERTONE, INC.

A DIVISION OF ASTRO-SCIENCE CORPORATION  
9449 West Jefferson Boulevard • Culver City, California

Please send detailed information on CONCERTONE

Series 90  505 Stereo Recorder  Transicorder   
Reverse-O-Matic  Series 500

Name \_\_\_\_\_

Address \_\_\_\_\_

City \_\_\_\_\_ Zone \_\_\_\_\_ State \_\_\_\_\_

CIRCLE 6 ON READER-SERVICE CARD

**"ROBERTS'  
Magic Memory  
is the  
BREAK-THROUGH  
you've been waiting for!"  
says GLENN FORD**



**GLENN FORD Joins a  
Host of Music Lovers  
in Acclaiming the  
Startlingly Different**

**Roberts**

**"440" MAGIC MEMORY  
4-TRACK STEREO  
TAPE RECORDER-REPRODUCER  
WITH BUILT-IN STEREO  
SOUND SYSTEM**

The sensational Roberts "Magic Memory" automatically re-plays all or any selected portion of a recorded tape • Fastest re-wind in history • Records and plays 4-track stereo • Plays 2-track stereo • Records and plays 4 monaural tracks • Complete with power amplifiers & speakers.

ALSO AVAILABLE: Model 144 DPA with pre-amps only — in portable case.

Send for Roberts great NEW Stereo Information Kit. 34 tape applications covered. Enclose 25¢ for handling and postage.

Roberts Electronics, Inc. Dept. HF-4-D  
829 N. Highland Ave., Los Angeles 38

Please send me:

Roberts Stereo Tape Information Kit containing 39 stereo and monaural applications. I enclose 25¢ (cash, stamps) for postage and handling.

The name of my nearest dealer.

I want a free, no-obligation demonstration.

Name \_\_\_\_\_

Address \_\_\_\_\_

City \_\_\_\_\_

State \_\_\_\_\_

**CIRCLE 97 ON READER-SERVICE CARD**

continuing with the same elaborately decorated, channel-jumping pops *divertissements* as before. *Colonel Bogey, Putting on the Ritz*, and *Picnic* are the top numbers here, and the recording is more stereoisitic, crystalline, and closely miked than ever.

**"Odetta at Carnegie Hall."** Vanguard VTC 1630. 44 min., \$7.95.

Except for her final four selections with the choir of the Church of the Master, New York, and for two striking unaccompanied "shouts," Miss Odetta Felious Gordon sings, in a distinctive near-baritone voice, to the accompaniment of her own sonorous guitar and the discreet string bass plucking of Bill Lee. She is by no means free from interpretative mannerisms, but few more powerful personalities ever have been projected on records. At her best, as in the heartwrenchingly tender *When I Was a Young Girl*, and *No More Auction Block for Me*, or in the catchy *Meeting at the Building*, her musical magnetism is as irresistible as that of her personality. The broadspread stereo recording captures both the big-auditorium atmosphere and the fervor of the audience.

**"Operetta Memories."** Mantovani and His Orchestra. London LPM 70041, 41 min., \$6.95.

Mantovani fans who were filled with longing when they read John F. Indcox's paean to the disc editions of this program last December will be delighted to find it made available so promptly in reel form. The tape processing has eliminated the need for any treble-trimming and bass-boosting in capturing the "miraculous . . . bloom" of the monophonic disc. As Indcox has stressed, this is Mantovani's best to date in its avoidance of interpretative excesses and in the appeal of its richly colored orchestral playing (especially in the selections from Lehár's *Friederike* and *Frasquita*). It is particularly recommended to those who in the past have disdained the public favorite, not unjustly, for his lack of good taste.

**"Oscar Peterson Plays the Harold Arlen and Jimmy McHugh Songbooks."** Verve VSTP 245 (twin-pack), 63 min., \$11.95.

The wealth of fine tunes and the pleasant variety of the soloist's stylings (ranging from frank cocktail hour sentiment to bouncy and sometimes slapdash near-jazz) make this one of Peterson's most attractive reels so far. But I wish he would give his skilled rhythm men greater chance to display their talents. On the Arlen side of the disc the markedly differentiated channels seem somewhat unbalanced.

**"Top Pop Instrumental Hits."** Cyril Stapleton and His Orchestra. Richmond RPE 45020. 26 min., \$4.95.

So many dance music programs are over-decorated nowadays that it is refreshing to hear one that is intent simply on pleasing one's ears. This bargain tape is relatively short, but everything in it is first-rate—not least its consistently gleaming and natural sonics. The label fails, unfortunately, to identify the gifted sax soloist whose rhapsodic soliloquies contribute so effectively to most of the fine performances here.

**"Brilliant"**

says **MARILYN KING**  
of the famous King Sisters  
Capitol recording stars



ONLY THE **Roberts**  
**"990" 4-TRACK STEREO  
TAPE RECORDER  
COMBINES THESE FEATURES**

- "Instant" multiple adjustment head • 4-track stereo record/play • 4-track monaural record/play • 2-track stereo playback • dual head outputs • dual pre-amp outputs • dual power amplifier outputs • dual monitor speakers • portable and easily custom installed.

**NEW! FOR YOUR CUSTOM  
INSTALLATION — THE ROBERTS 199-D  
TAPE DECK & A-905 AMPLIFIERS**

(as used in Model 990 above)

Send for Roberts great NEW Stereo Information Kit. 34 tape applications covered. Enclose 25¢ for handling and postage.

Roberts Electronics, Inc. Dept. HF-4-A  
829 N. Highland Ave., Los Angeles 38

Please send me:

Roberts Stereo Tape Information Kit containing 39 stereo and monaural applications. I enclose 25¢ (cash, stamps) for postage and handling.

The name of my nearest dealer.

I want a free, no-obligation demonstration.

Name \_\_\_\_\_

Address \_\_\_\_\_

City \_\_\_\_\_

State \_\_\_\_\_

**CIRCLE 98 ON READER-SERVICE CARD**



**Liberty** LT-7006  
EXOTICA-Vol. II  
Martin Denny



**Liberty** LT-7023  
PRIMITIVA  
Martin Denny



**Liberty** LT-7034  
EXOTICA-Vol. I  
Martin Denny



**Liberty** LT-7100  
JULIE IS HER NAME  
Julie London

# LOOK FOR THESE BEST SELLING



# TAPE RELEASES!

Write us for free catalog L-4 of over 150 Bel Canto releases.

Distributed Nationally By:

**bel canto** STEREOPHONIC RECORDINGS

**b** a subsidiary of Thompson Ramo Wooldrige Inc.  
1977-1985 McAllister Avenue  
Columbus, Ohio

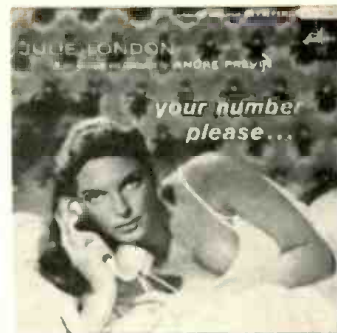

**Liberty** LT-7130  
YOUR NUMBER PLEASE...  
Julie London



**Liberty** LT-7140  
OMNIBUS  
Spike Jones



**Liberty** LT-7149  
ROAR ALONG WITH THE 20'S  
The Johnny Mann Singers



**Liberty** LT-7116  
EXOTICA-Vol. III  
Martin Denny



**Liberty** LT-7151  
THE FRANZ LISZT STORY  
Harry Sukman

*dedicated  
to  
perfection*



### 4-TRACK STEREO TAPE DECK

**MODEL RP-100W**

Completely assembled, wired and tested.  
**\$395.00**

**MODEL RP-100K**

Semi-kit includes a completely assembled and tested transport, electronics in kit form.  
**\$289.95**

Perfected 4-track stereo/mono recording, 4 & 2 track playback. True high fidelity transistor electronics, individual for record & playback, plus separate record & playback heads permitting off-the-tape monitor. 2 recording level meters, mixing, mic & level controls, switched sound-on-sound recording. Electrodynamically braked supply & take-up reel motors; hysteresis synchronous capstan motor. Individual solenoids for pinch-roller & tape lifters. All-electric, interlocked push-button transport control & interlocked safety "record" pushbutton. Precision tape guidance & sweep loading — no pressure pads. No slurring or tape bounce problems. Digital turns counter. Vertical or horizontal mounting. Modular plug-in construction. An original, exclusive EICO product designed & manufactured in U. S. A. (patents pending).

## NEW *MEDALIST* LINE . . . . .



### FM-AM STEREO TUNER ST96

Kit \$89.95 Includes Metal Cover and FET Wired \$129.95

FM and AM stereo tuners on one compact chassis. Easy-to-assemble: prewired, prealigned RF and IF stages for AM and FM. Exclusive precision prewired EYE-TRONIC® tuning on both AM and FM.

#### FM TUNER

Switched AFC (Automatic Frequency Control). Sensitivity: 1.5uv for 20db quieting. Frequency Response: 20-15,000 cps ± 1db.

#### AM TUNER

Switched "wide" and "narrow" bandpass. High Q filter eliminates 10 kc whistle. Sensitivity: 3uv for 1.0V output at 20db S/N ratio. Frequency Response: 20-9,000 cps ("wide"); 20-4,500 cps ("narrow").

## OF EICO STEREO . . . . .



### 70-WATT INTEGRATED STEREO AMPLIFIER ST70

Kit \$94.95 Includes Metal Cover Wired \$144.95

### 40-WATT INTEGRATED STEREO AMPLIFIER ST40

Kit \$79.95 Includes Metal Cover Wired \$124.95

**BOTH AMPLIFIERS:** Complete stereo centers plus two excellent power amplifiers. Accept, control, and amplify signals from any stereo or mono source.

**ST70:** Cathode-coupled phase inverter circuitry preceded by a direct-coupled voltage amplifier. Harmonic Distortion: less than 1% from 25-20,000 cps within 1db of 70 watts. Frequency Response: ± 1/2 db 10-50,000 cps.

**ST40:** Highly stable Williamson-type power amplifiers. Harmonic Distortion: less than 1% from 40-20,000 cps within 1 db of 40 watts. Frequency Response: ± 1/2 db 12-25,000 cps.

Over 2 MILLION EICO Instruments in use.  
Most EICO Dealers offer budget terms.



There's an EICO for your every stereo/mono need. Send for FREE catalog.



EICO, 3300 N. Blvd., L.I.C. 1, N. Y. HF-4  
 Send free 32-page catalog & dealer's name  
 Send new 36-page Guidebook to Hi-Fi for which I enclose 25¢ for postage & handling.

Name \_\_\_\_\_  
 Address \_\_\_\_\_  
 City \_\_\_\_\_ Zone \_\_\_\_\_ State \_\_\_\_\_

Add 5% in West.

Listen to the EICO Hour, WABC-FM, N. Y. 95.5 MC, Mon.-Fri., 7:15-8 P.M. © 1961 by EICO, 33-00 N. Blvd., L. I. C. 1, N. Y.

CIRCLE 45 ON READER-SERVICE CARD



# High Fidelity Newsfronts



by RALPH FREAS

**Tape Trends.** Those who responded to a recent HIGH FIDELITY reader survey revealed that only one type of equipment ranked higher in their immediate shopping plans than a tape recorder or tape playback unit. First place naturally went to loudspeakers—a circumstance that should surprise no one, since high fidelitarians have a habit of adding to or changing their speaker systems. And many have found that it's no trick at all to add speakers and switches and provide music—stereo or mono—for as many listening rooms as they wish.

The priority given tape recorders and playbacks over some other components surprised us at first. Then we recognized at least three reasons for the current trend towards tape. In the first place, for many of our readers the addition of a tape program source or recording facility will mark the completion of their sound systems. Second, the available repertoire and the sonic quality of four-track recorded tapes—at a comparatively low price—have grown tremendously in the past year. Third, (and this seems the most obvious reason) our readers are becoming increasingly aware of the many and varied uses to which a recorder can be put.

**Speeds and Quality.** Often, for eminently practical reasons, tape speeds are reduced and extremely wide frequency range is dismissed as an unimportant side issue. This is the case with American Concertone's "Transicorder." This tiny unit—"book size" the manufacturer dubs it—has virtues that far outweigh the drawback of limited frequency response at  $1\frac{1}{2}$  inches per second. A completely transistorized battery-operated portable, it weighs less than four pounds. The firm recommends it for dictation, sales



Concertone's "Transicorder."

meetings, surveys, and on-the-scene tape-recorded interviews. Playback through its self-contained amplifier and midget speaker is perfectly adequate. If ear-splitting amplification is needed, the tape can always be played back through a big system.

Watch, in the days just ahead, for a completely self-contained, wide-range portable for the "quality mass market." American Concertone also plans to introduce at about \$150 a tape player for the music listener.

**Improving the already fine** seems to be preoccupying many high fidelity producers these days. Rek-O-Kut, for instance, is bringing out its belt-driven turntables with a new belt. Made of polyurethane, the belt—with its high coefficient of friction—reportedly "really grabs the drive spindle" to provide even steadier and quieter platter rotation than before. Dubbed the "Rek-O-Thene," the virtually indestructible belt also is being sold separately for \$2.95 for use on older Rek-O-Kut belt-driven turntables. The company also is readying a new installation aid for turntable users. Known as the "Acousti-Mount" kit, it will sell for \$3.50 and provide a set of "floating springs" to help kill acoustic feedback in some installations. Finally, word is abroad of an "omni-balance" kit, \$2.95, which consists of a small counterweight that attaches permanently to older Rek-O-Kut tone arms and thus converts them to new S-320 model.

**Low Fidelity Wood.** A feature article in the March issue treated the subject of cabinetry. If you still wonder whether cabinets come in high, low, and medium fidelity models, an action by the Federal Trade Commission several months ago should put doubt to rest. The FTC had nine phonograph manufacturers sign agreements to furnish information disclosing the materials put into their cabinets. The group of nine firms include the biggest and probably account for about eighty per cent of the "packaged" (or non-component) phonographs sold in the United States. Some cabinets were said to resemble wood closely enough to fool the public. Such terms as "mahogany-grained finish" and "blond oak-grained finish" had been used to describe hardboard or metal, finished to look like wood. While the buyer today now has a label describing the cabinet to guide him, he still has no assurance,

however, that mechanical feedback is not built right into his "hi-fi."

**Reverse Process.** We submitted above (the purely hypothetical idea) that a tape recorder is the *final* touch to The Complete High-Fidelity System. But in Sun Valley, California, there abides a tape



Sony's popular-priced stereo deck.

recorder manufacturer dedicated to the proposition not that this isn't so, but that it shouldn't be so.

"The tape recorder," asserts Sony Superscope's Joe Tushinsky, "is the first component people ought to buy."

If you disagree to the extent that you have bought every component *but* a tape recorder, you will be a disappointment to Mr. Tushinsky. He won't give up though. He'll recommend his Superscope Model 262-D tape transport, a budget-priced (\$89.50) deck designed to fit right in with the equipment you already own. The unit will record and play back four-track stereo. Its transport mechanism and heads are the same as those in the Model 300, about which this magazine reported "performance . . . is outstanding, with very low wow and flutter."

Watch for a very special new professional model from the firm. Completely transistorized, it will sell for about \$695.

**Brief on Baffles.** Do most people think of a speaker system only as a box with two terminals? Not in the view of A. A. Ward, the man guiding Altec Lansing.

"We sell as many speakers without enclosures as we do with them," Mr. Ward told us recently. "Look at this."

He proffered a booklet written by Altec Chief Engineer A. Badmaieff. Entitled *Loudspeaker Enclosures—Their Design and Use*, it is intended to help the nontechnically minded extract the sonic ultimate from Altec speakers by housing

## Unmatched for Excellence



... its performance specifications have not been equalled!

The full meaning of Marantz Quality becomes clear when you compare competitive performance features with those inherent in the Marantz design. It becomes apparent that: 1—hum, noise and distortion are all many times lower in the Stereo Console; 2—accuracy, sensitivity and reliability are all much greater, and; 3—its superb precision construction has no counterpart in the field. Most of these are the important characteristics which directly determine sound quality.

Let's see how much more one gets for his investment in Marantz:

■ **LOWEST DISTORTION** 1. M. Distortion @ 10V equiv. pk. RMS: 0.15% max., 0.1% typical. (Reduces to a few hundredths of 1% below about 5V output.)

... at least 2½ times less distortion!

■ **LOWEST HUM & NOISE** Total noise, 20-20,000 cps: 80db below 10mv input. (equiv. noise input: 1 microvolt max., 0.8 microvolt typical.)

... at least 3 times quieter!

■ **HIGHEST SENSITIVITY** RIAA phono @ 1kc. 0.4mv (400 microvolts) for 1V output.

... at least 50% higher sensitivity!

■ **GREATEST ACCURACY** Equalization and tone control curves matched in both channels to 0.5db max., 0.2db typical. RIAA phono curve accurate within 0.5db (no false bass "hump"). Volume control, developed especially for Marantz, has over 90db adjustment range, and better than 2db tracking to -65db. This greatly reduces need for rebalancing.

... much more accurate reproduction!

■ **FINEST CONSTRUCTION** Instrument-type, precision construction throughout. Basic circuit on heavy, lully shock-mounted turret-terminal board. Wiring neatly cabled. Noise-selected film resistors. Power transformer double-shielded with mu-metal before "potting". Triple-filtered D.C. filament supply. Fully finished chassis. Front panel, ¼" thickness brushed aluminum, pale gold anodized, with precision-machined matching knobs.

... better quality, inside and out!

■ **MOST RELIABLE** The individual test report packed with each unit assures you that it has undergone the most thorough inspection, adjustment and test in the whole industry. Every unit meets all its claims.

... backed by new two year warranty!

The cost? A little more . . . but well worth the difference. Model 7 Stereo Console . . . \$249\* (less cabinet).

Model 8 Stereo Amplifier is a perfect match in performance and quality. \$237\*

Write for folder 41F \*Higher in West

# marantz

25-14 Broadway, Long Island City 6, N. Y.  
CIRCLE 79 ON READER-SERVICE CARD

them properly. Six pages give simple schematic diagrams, dimensions, and plans for the enclosure builder. A person with only the sketchiest knowledge of carpentry is encouraged to tackle the speaker-housing problem. Mr. Ward assured us that the booklet will be available as long as there is a demand for it.

That the demand will keep on is pretty certain, but we can't resist raising an eyebrow at that half of the public which passes by Altec's elegant, ready-built enclosures in favor of constructing their own. In any case, the booklet will be sent on request to Altec Lansing, 1515 South Manchester Ave., Anaheim, Calif.

**Terminals Too!** The people at Jensen, another of our oldest speaker manufacturers, also take pains to make evident that a speaker system is not just a box with a pair of terminals. In stores throughout the country, they're showing their TF-3 "four-speaker, three-way system" with the grille cloth stripped away. But don't for a moment think that the firm intends the purchaser to place the TF-3 in his living room with naked speakers. The unit sold will be clothed in the customary way. Jensen, in fact, is a company that particularly stresses appearance as well as sound quality. Its catalogue 165-F, for example, shows its product in a variety of decorator settings. Not only does the catalogue explain fun-

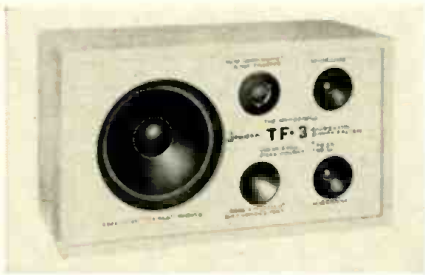

Behind the grille cloth. . . .

damentals of acoustics and loudspeaker performance, but it provides a quick course in decorating. For a copy, send to Jensen Mfg. Co., 6601 So. Laramie, Chicago 36, Ill.

If you miss seeing the "naked" TF-3 at your dealer's, here briefly is the speaker complement Jensen wants you to be conscious of: 10-in. woofer, two 3½-in. midrange units, an ultra-tweeter (the "Sono-dome"). The bass is enhanced by a duct-loaded port. A bookshelf unit, the TF-3 is priced at \$79.50.

**"Sound Studio in a Suitcase"** . . . is one way of regarding a tape recorder. It's a description that Robert Newcomb considers sufficiently apt to apply it to his Newcomb Model 310 stereo recorder, a machine available in two- and four-track versions. We asked the scholarly Mr. Newcomb if he provides a conversion kit for two-track recorder owners.

"We prefer to make the conversions ourselves," said he. "This enables us to guarantee performance. The SM-310 is a precision instrument, and we want to keep it that way."

According to Newcomb's specification sheet, the SM-310 is "cybernetically engineered for intuitive operation"—a prin-

ciple which has nothing to do with the number of tracks it will record or play back. Cybernetics (from the Greek word for "steersman") is a handy term that gets plenty of use in engineering circles. It's the study of the body's control system (nerves and brain) as compared with

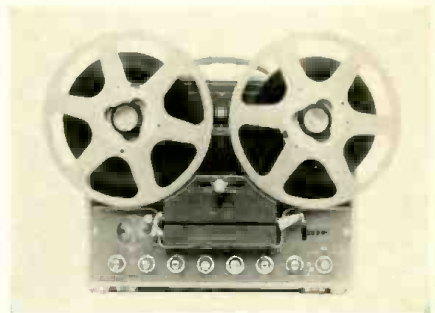

Cybernetics for stereo.

such electro-mechanical devices as computers. As Robert Newcomb uses the term, it refers to the tape transport control—a joy stick, really—with which "the natural thing to do is the right thing to do" in operating the SM-310.

Newcomb, by the way, believes that there is too much effort made to put tape recordings on a competitive price basis with discs. Tape, in his view, should be considered as something quite separate. Reduction of speed for the purpose of ultimately reducing the cost of the tape also reduces quality, he says sadly. One gets the impression that he will resist any move to halve tape speeds.

**Lazy Listening.** Automatic reversal on tape recorders, push-button devices to semi-automate a turntable, automatic tape threaders—manufacturers seem bent on taking all the work out of music listening. The latest device for the lazy high fidelitarian is a remote control FM tuning attachment. Tuner manufacturer Lester Karg is the man who developed this one for his crystal-controlled tuners. Two models are available; the Mark I (\$19.95) and the Mark II (\$29.50). Both are mechanically, rather than electrically, coupled to the tuner; there is no wiring to be done. They are push-button operated and motor driven. The more expensive Mark II has an extra button for a "sensing switch." This activates the tuning attachment and stops the tuning dial right in the middle of the next station. Karg dreamily suggests that the ideal use for the Mark I or II is in a system that has a remote speaker in the bedroom. You wouldn't have to get out of bed to change FM stations—just hit the button. Twenty feet of connecting cord is supplied, but the user can add as much cord as he needs to bring the remote control unit to the bedside. Ho-hum. Now if someone would only invent a shoe-tying device for those of us who've put on so many pounds from lots of listening and lack of exercise that we can't bend over. . . .

**Sitting In.** Roberts Electronics is proud—justifiably—about a tape recorder model called the "Duet." This designation, according to Roberts' Eugene Freeman, conveys better than any other term

the sound-on-sound function of the company's Model 90-D. When he thinks about the "Duet," Freeman pictures thousands of music students in solitary practice at home with trumpet, violin, or other solo instrument. By the student's side—shall we imagine a boy clarinetist?—is the "Duet." With sound-on-sound, he is able to tape record favorite tunes from discs or radio, play them back, and inject his own hopeful virtuosity into the same recording. In a sense, he sits in as a member of the orchestra.

Seems to us a good way of stimulating interest in music studies. It also enables the student to check his progress from time to time and take encouragement now from his own recorded tapes made—let us say—a year ago.

**'Way Beyond Audibility.** Dick Rose of Stephens Truonic took time to show us a prototype of a new tweeter the firm is manufacturing, the Model RT-1. As he explained it, the tweeter is capable of going out to 86 kc, but the company has no intention of exploiting the fact.

"No one can hear that high," Rose explained.

But can the user "feel" it?

"Feel it? It isn't on the record," Rose insisted. "I talked to one of our leading recording engineers recently. He told me that his firm—and it's a big one—doesn't record higher than 15 kc. The first pressings of a record have full frequency, but in later pressings the highs drop off considerably. Then, when a disc is played, more and more of the high frequencies are lost with successive playing."

Rose didn't say exactly what Stephens would claim as a high end for the RT-1. He did point out that the unit has a built-in crossover (at 6 kc) and attenuator control. It is priced at \$26.50.

**Tape on Wheels.** A Wollensak spokesman, J. C. Landen, reports that his firm is almost ready with a tape recorder model with special appeal to motorists. It's an "automotive model" so new that a catalogue number has not yet been designated. Why "automotive?"

"This unit," Mr. Landen explained, "has a built-in inverter and a plug that fits into an automobile's cigarette lighter. It operates off the car battery. The user can readily dictate, or play, a choice of recorded music on tape while parked or driving. Or, he can provide the musical entertainment for a beach party or a picnic."

This automotive model, added Mr. Landen, is non-automotive as well. It has an additional power cord and plug, permitting it to be connected to an AC outlet at home, as well as at summer cottage, motel, or wherever your car takes you.

By the way . . . If you considered buying the Garrard Type A automatic turntable after reading the Equipment Report on the unit in our March issue, you may have thought that you were overcharged. Actually, the price has been changed from \$69.50 to \$79.50 since our report was published.

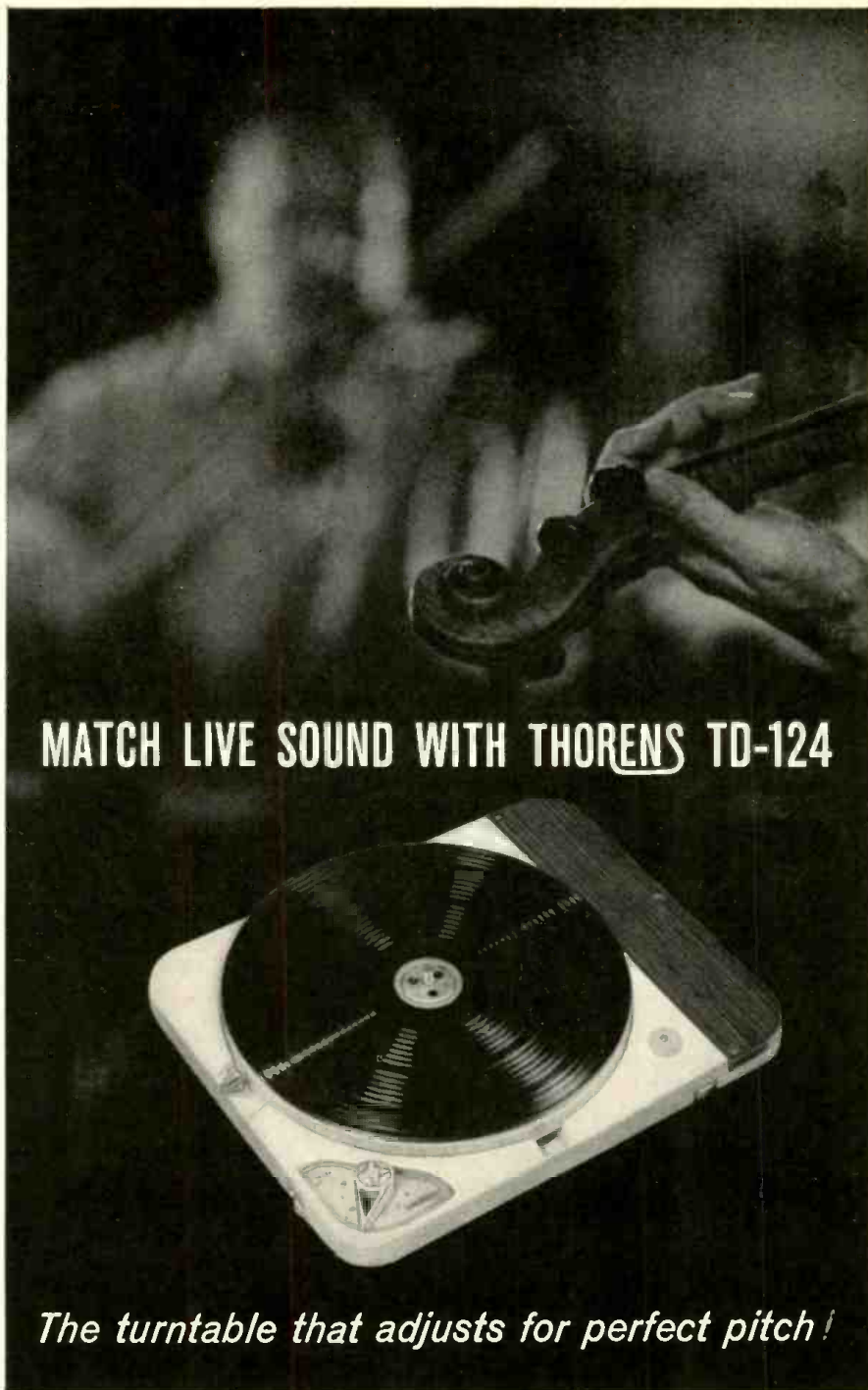

## MATCH LIVE SOUND WITH THORENS TD-124

*The turntable that adjusts for perfect pitch!*

Thorens compensates for variations in house current and recording systems; gives the truest reproduction with all your records, old or new. Adjustment is so fine that records can be used to accompany *live* vocal and instrumental performances. Swiss precision engineering ensures longer record life, performance to match the finest components you will ever own. See your Thorens dealer soon for expert attention and high fidelity service.

- 4 speeds adjust while record plays
- Illuminated strobe and circular level built in
- Easy installation of 12" and 16" arms
- Only \$99.95 net. Other models from \$47.50

**Guaranteed for one full year. Sold only through carefully selected franchised dealers.**

# THORENS

A Division of  
ELPA Marketing Industries, Inc.  
New Hyde Park, New York



FAMOUS SWISS HI-FI COMPONENTS • MUSIC BOXES • SPRING-POWERED SHAVERS • LIGHTERS  
CIRCLE 120 ON READER-SERVICE CARD

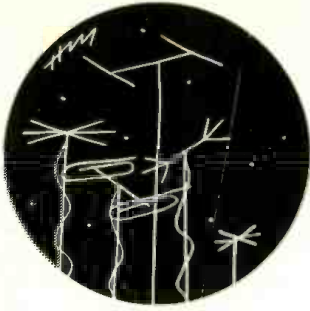

## FM ANTENNAS:

### *How To Get the Best From Your Tuner.*

By Charles S. Tepfer

WHEN YOU BUY an FM tuner the manufacturer includes an antenna (usually about five feet of the familiar TV twin-lead) formed into a "T." Such an antenna, called a dipole, is about as effective for FM reception as a "rabbit ears" indoor antenna is for TV. If you are close to the broadcasting station, you will get a good signal. If you are fairly distant, however, you will get the aural equivalent of TV snow and ghosts: distortion and interference from other stations. Additionally, you will not be able to tune in all the FM stations you could be listening to because such an antenna simply is insensitive to minute signals from distant stations. A good outside (or attic-installed) antenna can do the trick.

You can use your roof-mounted TV antenna to feed your FM tuner too, with good, though not optimum, results. The addition of the FM tuner to the TV line requires the use of a two-set coupler to minimize whatever interference and other disturbing effects the FM tuner and the TV set may have on each other. A two-set coupler is a small network enclosed in a convenient package with one set of antenna terminals and two sets of terminals for the leads that go to the receivers. Such couplers may be obtained from electronic parts stores, mail order houses, or from your TV serviceman. If your FM tuner has two sets of antenna terminals, one marked "300 ohms" and the other "72 ohms," use the 300-ohm set

when making connections to a coupler.

TV antennas, however, are not specifically designed for FM reception. Most broadband or all-channel type TV antennas are "peaked" to channels 4 and 10, the centers of the low and high VHF bands. This design compromise allows the antenna to act effectively for channels 2 through 6 and 7 through 13. But the FM band which is smack in the middle between TV channels 6 and 7 receives token or partial benefit from the antenna. The FM tuner is deprived of its maximum station pull-in power as well as its noise-limiting effectiveness for distant or weaker stations.

A variety of FM antennas are available. They resemble TV antennas, differing only in the length of the individual arms or "elements." These elements are just the right size to accommodate an even fraction of the FM wave, so as to transfer its signal energy most efficiently to the tuner. The better FM antennas incorporate design features to maintain this effect over the entire FM band.

The more elements an antenna has, the greater its sensitivity or "gain." This is measured in terms of decibel (db) units. The gain of the indoor "T" type antenna furnished with an FM tuner is 0 db, that of a multi-element outdoor antenna can be as high as 10 db or more. The higher the antenna gain, the stronger the portion of airborne signal delivered to the tuner.

High gain is achieved by sacrificing the omni-directional response of the antenna. As the number of elements in the antenna is increased, it produces a "flashlight lens" effect, and the number of directions from which the antenna will pluck signals becomes smaller. High-gain antennas, in short, take most of their signals from straight ahead, few from the sides, and practically none from the rear. Thus, if all the stations you want to receive lie in the same direction from your house you can use a directional antenna. But, if you plan to hear stations in different directions from each other, then you must use a nondirectional antenna with lower gain, or two or more directional antennas, each one oriented to a different station or group of stations. Another alternative is to use a single directional antenna mounted atop a rotator, with which you may turn the antenna to any direction, any time. Good rotators are available for about \$20 to \$30.

The antenna you choose, therefore, depends on your needs. If your TV antenna brings in all the FM stations you want, use it. If, in addition, you want to hear the programs of stations located in a direction different than that of your TV antenna orientation, add an FM metal dipole antenna onto the TV mast (and at least thirty inches from the TV antenna), broadside to the desired location. If you want distant stations that neither antenna can draw, get a multi-element, high-gain FM antenna of the "yagi" type. Yagi antennas may be designed for one station or for many stations. If the stations are scattered in all directions around you, use a rotator with the Yagi.

Should you install the antenna yourself, a chimney mount, a ridge mount for peaked roofs, or a tripod mount for flat roofs may be used. All of the hardware is available from the electronic parts store where you buy the antenna. Use TV-type twin-lead for all antenna wiring, directly to the receiver, and avoid splices. A few words of caution: when running the lead from the antenna to the receiver, keep it away from metal rain gutters and downspouts; do not run the lead down through the antenna mast; and do not coil excess lead behind the receiver—cut it off.

If you find you pick up interference, try coaxial cable (specify RG-59/U) and connect the ends to the 72-ohm input of your tuner, if the tuner has it. You may also install an interference eliminator (about \$5), installed as close to the receiver's antenna terminals as possible.

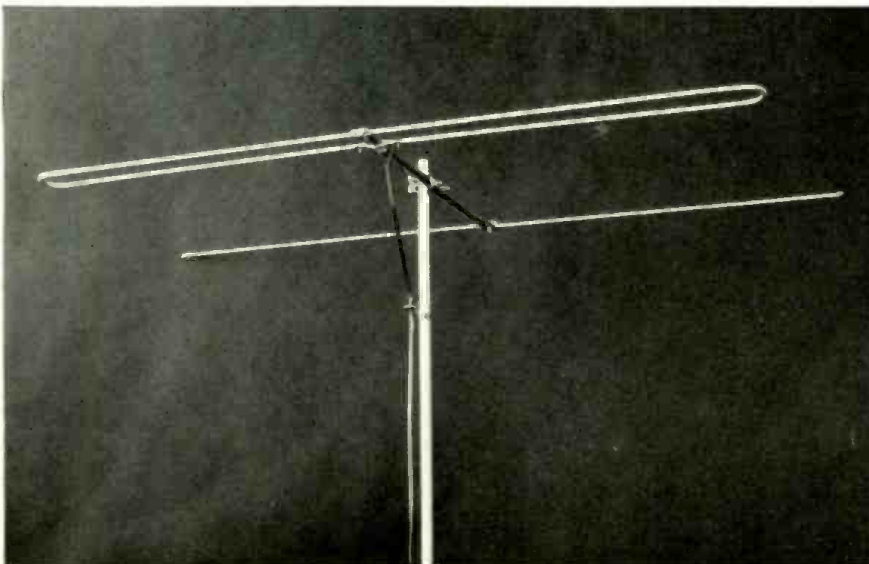

*Twin-lead run through stand-off insulators feeds signal from folded dipole.*



**THE  
A. E. S.**

*Gigolo*

.....A  
**MIRACLE IN SOUND**

After two years of research and development, a speaker system we can offer to the public on a 100% MONEY BACK GUARANTEE. Compare the A. E. S. Gigolo, to any bookshelf speaker, regardless of price and if you do not feel that the Gigolo is the most outstanding unit you have heard, you may return it for a full purchase price refund.

Thousands of these gigolos are now in use all over the country. The acceptance has been unbelievable. Never before a sound so realistic to so many people in so many different homes! These are the facts that enable A.E.S. to make this bold offer.

Size —  
24" wide, 12" high, 9 1/2" deep.

Power Handling Capacity —  
The Gigolo is extremely flexible. May be used with small economy amplifiers of very low wattage, as well as with the highest power component amplifiers with satisfactory results.

Frequency Response —  
The Gigolo will reproduce both high and low frequencies in excess of the requirements of even the most critical home listener.

Order now to insure prompt delivery  
Price — \$15.00, F.O.B. factory  
Unfinished only  
Price subject to change within thirty days of the issuance of this magazine

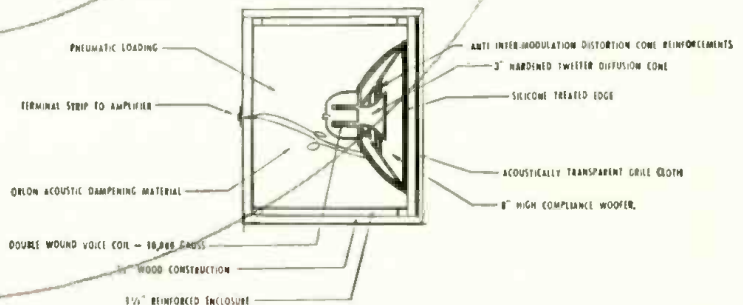

**ORDER BLANK**

A.E.S., Inc.  
3338 Payne Avenue, Cleveland, Ohio

Gentlemen please ship .....GIGOLOS.

I understand these units are guaranteed and if I am not satisfied I may return for a full refund of sales price, \$15.00 each.

Name .....

Address .....

City and State .....

Enclosed find check ..... money order .....

# DYNACO

MAKER OF THE WORLD'S FINEST  
HIGH FIDELITY COMPONENTS

*proudly presents  
the all new*

## dynatuner

*superb companion  
to your*

## DYNAKITS



### EASIEST TO ASSEMBLE

Dyna's traditional streamlined circuits and etched circuit boards enable complete construction and alignment in 6 hours.

### SIMPLEST TO ALIGN

You achieve minimum distortion and maximum sensitivity—yourself—without any instruments.

### UNPARALLELED PERFORMANCE

Highest effective sensitivity plus lowest distortion plus superior quieting plus precise, drift-free tuning.

Hear and compare it at your favorite dealer's showroom.

Write for complete specifications

## DYNACO, INC.

3912 Powelton Ave. • Phila. 4, Pa.  
CABLE ADDRESS: DYNACO, PHILA.

CIRCLE 43 ON READER-SERVICE CARD

Continued from page 43

## The Claude Hummel Diary



make a little money (nobody makes a lot).

I have been reviewing for only ten years, yet I can think of dozens of such moments of delight, often unexpected—Abravanel's *Judas Maccabaeus*, Boult's *Acis and Galatea*, Simonetto playing Wolf-Ferrari's *I quattro rusteghi*. Fleisher's Mozart, Gould's Bach, Frager's Prokofiev Second, Graffman and Hendl's Beethoven Third, Walter's Brahms Third, Noah Greenberg's Pro Musica, Renato Fasano's *Virtuosi di Roma*, Karl Haas's London Baroque Ensemble, Robert Craft's first Gesualdo record, Klemperer's Ninth, Ackermann's Strauss operettas and Leibowitz's Offenbach operettas, Tebaldi singing *Desdemona*, Scherchen's Bach Mass, the Elliot Carter Cello Sonata, the early Vanguard recordings of Mahler's *Knaben Wunderhorn*. . . . The list could stretch on and on, each an hour or more happily fresh in the mind, renewable on call—if only one could somehow manage to get caught up on the current crop of releases.

Claude had these moments, too—though being a shy man he was always afraid to express them as he felt them. You could tell when Claude really loved something only if you knew Claude, and knew that he became even more ponderous to read when his deepest affections were aroused. What he wrote for publication never contained such outbursts of joy as this entry in his diary. Alas, it is the last cheerful entry. If only there had been something else Claude liked in those boxes that mounted ever higher in the hallway, perhaps he would not have disappeared.

SUNDAY: Disaster all day. The first record I put on was supposed to be Gregorian Chant, but it actually was some pig of a tenor singing *Ritorno a Sorrento*. Why do these things happen to me? The next record was off-center. I then played a recording of the Mozart *Hunt* Quartet, employing the notes say, Dr. Alleleghsdruck's patented dynamic expander. Through this device, it has been possible to record a quartet with so great a dynamic range that when a *forte* is correctly loud the *pianissimo* will be inaudible, and when a *pianissimo* can be heard the *forte* will break the glassware in the kitchen. Extraordinary! Unfortunately, one of the violinists had a

very raspy way of breathing, and I believe the cellist was wiggling his toes—I can think of no other explanation for that annoying sound. The next record was so warped that when the stylus was in the trough the hill hit the arm. The next, though apparently a harmless recording of the Beethoven Fifth (the recording made, interestingly, in an anechoic chamber), was clearly a test record for audio designers. I tried six different pickups, four arms, and two turntables, in various combinations, and could not find anything that would track the first grooves. This took a great number of hours. I was almost tempted to go out for dinner, but I cannot afford the time. I am even further behind now than I was last month, there are still 169 records on the shelves which hold what I have not yet heard. From now on I must listen as I eat.

MONDAY: "G" was over this morning to take a look at some of my older editions of *Grove's Dictionary*. Poor devil—he must write the notes for a violin concerto by Worltzitz, known to "G" only as a composer of wholesome, damnable Viennese operettas. No score to the concerto is available in New York, nobody can be found who has ever heard of the thing, and the notes must be written before the tape arrives here, because the printing schedule for the jacket runs ahead of the pressing schedule for the record. The best I could do was to show him the carbon of the notes I once wrote for excerpts from *Woolfswaffe*, a little operetta entirely in E flat, about a boy and a girl who turns out to be a Countess, the plot involving babies changed at birth, a mistaken-identity love affair with a transvestite twist, a soldier believed killed in a battle but actually pretending to be Blücher so Blücher could go somewhere else, and a dog, which acts as a sort of *canis ex machina* and was written into the opera because the prima donna would not appear on stage without her dog. "G" read my notes and my *Grove* while I listened to a contemporary composition for two oboes and tambourine, which I knew would not distract him. The record shows very imaginative use of stereo technique, with one oboe in each speaker and the tambourine drifting back and forth between the two. The piece was written accord-

ing to the formula  $ax^2+yz=0$ , where  $z$  is a constant, and it has the form of a parabola.

"G" left very gloomy, having verified in *Grove* that the concerto existed, and having learned that it was known as the *Matilde* Concerto. Poor fellow, he has little on which to base his notes. And yet, he will do an excellent job. He will find something in Hanslick, something in Hunecker, something in the letters of Nikisch. He will build a fine if not very strong cage in which people can keep this beast of a concerto, if they wish.

Eleven records today, all trash. On one jacket, *A Night on Bald Mountain* is wrongly identified as *The Ride of the Walküre*.

**T**HIS is the last wholly coherent entry in Claude's Diary. Among his papers I discovered a letter from Alicia, which he must have received Tuesday morning. It informed him that she had gone to the Congo, "to seek peace," leaving the younger children with her sister in Grand Rapids. This letter may have been what finally unhinged Claude, but from what I can make out of the progressively more anguished scrawls of the final days I believe it was overwork: too many records, and, especially, too many album notes.

It is fitting that Claude should bow out on the crashing chords of liner notes, because he himself gave so many hours to their composition. We did not always agree on what constituted a good commentary for a record jacket. I felt, for example, that there was much to be said for the nontechnical essay, of the sort that Vincent Sheean and Henry Simon have contributed to Victor opera albums. I felt, too, that the sort of elementary précis writing about key relations that sometimes appears was worse than wasted effort (even when it is accurate, which sometimes it isn't). Where the technical effect is famous—as in Schubert's return to the tonic in the slow movement of the big C Major, or the "false interval" on the horn in the first movement of the *Eroica*—there might be some point in explaining, for the benefit of those who came in late, why the thing

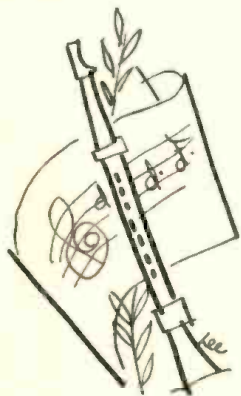

is remarkable. But little purpose can be served by the hacking apart of a Brahms Quartet into subjects, second subjects, modulations, canon, fugato, and so forth. It is caviar to the general and precooked baloney to the particular.

Yet I could not quarrel with Claude when he argued that "Music is written on paper, yes? Why should you not see what is written?" We agreed completely in our admiration of Klaus Roy's workmanlike notes for Epic. A quotation from the score is never entirely wasted, and it is always better than the kind of puffery one often finds—the touting of second-rate stuff as "a neglected masterpiece" or of first-rate stuff as "the great coda which carries the listener to more exalted Planes of Being." Jacket notes, after all, are like program notes at a concert. The writer of program notes, as Tovey once pointed out, "is engaged as counsel for the defense," and may not express his true opinion of a work he does not like. The writer of record notes works under the same handicap, but he is not obliged to gush—and he is certainly not obliged to go into ecstasies over the performance his fortunate reader is hearing.

The function of the notes is to supply some information—about the work, the circumstances of its composition (where significant), and its place in the composer's output, and whatever is really worth noting about its structure—thematic, harmonic, rhythmic, or architectural. If the information is trite, the notes cannot be original—but that is scarcely an excuse for writing notes which do not give information. The worst Germanicisms (one recalls, for example, the Anglicization of "Renato" to "Reinhardt" in a memorable translation of the libretto of Verdi's *Ballo in maschera*) are preferable to a meaningless lyrical commentary on the composer, the music, the instrument, or the facial gestures of the artist.

The last pages of Claude's diary are punctuated by expletives directed at liner notes. Many of his comments are, I think, unjust, and nearly all of them are unprintable. As I make out the last jagged patten in the Diary, it refers to the section "Mozart Reports on a Recording Session," an imaginary exchange of letters in which the composer praises to his father the stereo recording techniques of RCA Victor in the sessions which produced the recent *Don Giovanni*. Claude's final entry appears to be a quote from these letters as they appear in the booklet: "And for those with monophonic equipment, the recording that is made from these tapes will sound even better than what they have been hearing before." This example of Mozartean prose is followed by Claude's scrawled, "*Libera me, Domine! Libera me!*"

One cannot seriously disagree with the violence of Claude's reaction: those "letters" might have driven any of us to seek desperate solutions. And for all we know, Claude may still be among us somewhere, seeking such solutions. He has disappeared, but we may hear from him again. Certainly, the man responsible for those "Mozart letters" would be well advised to keep his shades tightly drawn and his door double-locked when he goes to bed at night.

Now that I think about it, perhaps I had better lock some doors myself. Excuse me. . . .

## RECORDS SOUND BEST with **DYNACO** **STEREODYNES**

Choose either the Stereodyne II (mounts in all standard arms) or the slim, trim TA-12 arm-cartridge combination for the most natural sound from both stereo and mono recordings.



TA-12  
\$49.95 net

\$29.95 net

### DESIGNED TO THE HIGHEST DYNACO STANDARDS

- ★ unequalled performance
- ★ outstanding engineering
- ★ unsurpassed value

Rigorous laboratory testing of every unit assures that your cartridge will exceed every specification.

- Smoothest response:  $\pm 2$  db from 30 cps to 15 KC. With standard Westrex 1A test disc.
- True stereo: More than 22 db channel separation effectively maintained throughout the audio spectrum, with accurate balance and proper phase relationship.
- Superior tracking: highest compliance, low mass, plus exclusive symmetrical push-pull design for minimum record wear and lowest distortion.
- Complete freedom from hum.

Hear and compare it at your favorite dealer's showroom.

Write for complete specifications

**DYNACO, INC.**

3912 Powelton Ave. • Phila. 4, Pa.  
CABLE ADDRESS: DYNACO, PHILA.

CIRCLE 44 ON READER-SERVICE CARD

## SOUND TO COME

Continued from page 68

stunning possibilities for sound reproduction. There's no reason, incidentally, why the digital process can't be used on TV and FM signals—with vast improvement in the quality of reception.

So we see three lines of possible evolution for the *means* of recording sound; we have not yet even considered the evolution of playback equipment. Where, in this world of flux-responsive magnetic recording, thermoplastics, and digital coding, does the old-fashioned plastic disc fit in?

It won't vanish overnight. Flat discs have certain characteristics of simplicity and convenience that will keep them around well into the future. They'll be improved, of course. Injection molding instead of 1961-style flat-bed pressing will improve disc quality, cut down on production time, and eliminate waste in manufacture.

The big drawback of discs is that they wear out—the grooves deteriorate under repeated playing. But the use of photo-cell optical scanners in place of stylus-tipped pickups will end that problem. The revolving disc will pass under a beam of light that will play the pickup's part in transmitting information from grooves to amplifier. No physical contact between pickup and groove, no friction, no record deterioration, and a guarantee of perfect tracking without a chance of distortion, overloading, or groove jumping! The optical pickup may give such impetus to conventional discs that the more startling means of recording may not come into use for many, many years.

At the other end of the system—the loudspeaker—two revolutions are in progress to replace today's moving-coil speakers. Electrostatic speakers have been with us for some time, but until recently their use has been limited to the high frequencies. Now electrostatics are being produced for the full audio range—big, flat speakers just a few inches thick. Another newcomer is the ionic loudspeaker, which has no moving parts at all, just a column of ionized air. Increase the ionization, and the column of air pushes outward on the air around. Decrease the ionization, air rushes in. That's all that a conventional speaker does, after all—pushes out, pulls in. And sound is produced.

As for the components that make up the guts of any sound system, really awesome changes are on the far horizon. Transistorized components will probably be the first step. But the big development will come in a decade's time, maybe sooner, when molecular electronics has come into its own. Semiconductor pioneers like Texas Instruments and Westinghouse are already well along toward production of the first "moletronic" radios—which will be pea-sized and sell for five or six dollars. The process involves *growing* complete semiconductor circuits within a single crystal. Amplifier, preamp, and a tuner all can be organically evolved in a thumb-sized capsule, produced at little cost once volume manufacture commences. The idea

of repairing your sound system will become obsolete. In case of a burn-out—which may happen no oftener than once a century—you'll simply toss out the old component and plug in a new one.

Loudspeakers have to be a certain minimum size, for reasons beyond human control. But the components can be reduced almost to microscopic sizes through molecular electronics. It's quite plausible that in time we'll have pea-sized stereo FM tuners which can be inserted, one in each ear, to give full-frequency listening.

So the distant future begins to come into focus. A scanner beam in place of a pickup, a semiconductor "rock" to replace the electronic innards, and a column of ionized air in place of speaker coils—all adding up to a sound system of redwood-style longevity. The advent of digital coding will bring about the combining of sight and sound, too, all in the same neat package. The gadget demonstrated in the fictional episode above—the "binoculars" that record and play back a complete opera—follow logically enough from the possibilities at hand. One playback angle could be an electrostatic speaker covering an entire wall, coated with an electro-luminescent TV picture tube a few molecules thick. Sound and picture would come from the same wall. The newly invented light amplifier, or LASER, may someday bring about this kind of arrangement. You'll be able to play sight-and-sound recordings of operas and concerts. The same equipment will pick up TV, FM, and other signals. The possibilities are boundless.

Today, FM transmission is limited, for all practical purposes, to a radius of about 100 miles. That won't be so tomorrow. A network of space satellites, orbiting some 22,000 miles up so they'll remain fixed over the same point on Earth, can be used to relay FM signals around the world, either by reflection (as in the Echo satellite) or by pickup and rebroadcast (a specialty of our Courier satellite). It will be no trick to tune in FM broadcasts from Europe.

At this point, the owner of a 1961-style stereo rig, pleased with the way things sound right now, might well be expected to ask, "Why not leave well enough alone?"

The answer, of course, is that it isn't a human characteristic to leave well enough alone. So long as there's a challenge, a way of improving the already-pretty-good, men will be at work trying to reach the next level. But don't sit it out on the sidelines until the above described wonders reach the stores. You may have a long wait. Revolutions happen slowly, and digital coding, thermoplastic recording, photoscopic storage, and all the rest are still glossy words of the future. Meanwhile, we're living in 1961. We have a wealth of good music at our command. We have attained an excellent level of music reproduction. The thing to do is to make the most of today's sonic opportunities—and to look forward to the miracles that will some day step out of science fiction and into our living rooms in the decades to come.



Which of these pieces of fine furniture is a speaker system?



All of them. They are new SCOTT "Reflection Coupler" Stereo Speaker Systems, featuring authentic styling, all hardwood construction and no grille cloth, because the SCOTT System plays against the walls and ceiling to endow the reproduced music with a realism no direct radiator can possibly match. Hear the System at your franchised SCOTT dealer. For literature, price lists, and technical specifications, write Dept. C-1

Patent Applied For

# SCOTT

SCOTT RADIO LABORATORIES, INC.  
241 West Street, Annapolis, Md.

"The Sound of SCOTT is the Sound of Music"  
CIRCLE 106 ON READER-SERVICE CARD



## BARONS OF BAYREUTH

Continued from page 65

Wahnfried in Bayreuth, a tall, large, imposing woman much deferred to whenever she attends a Festival performance.

By the time Kraft's scenario reached 1945, you could almost see the writer's nose wrinkling: "... the Festival Playhouse, graciously spared from all destruction in the singing smoke of neighboring fires. Siegfried Wagner's first home at Wahnfried street turned into an American officer's mess. A different screen-picture series: the fates of the Festival Playhouse since May 1945. The retreat of the colored men. The house is restored to its destination as a 'Cultural Institution.' Beyond the orchestra a kind of front-stage, reaching up to the stalls has been erected. Rows of nude girl's legs keeping time with the whirl of fanaticized saxophones. A revue for the American soldiers. . . . A short retrospective glance upon the first postwar time shows some unpleasant scenes. Certain anonymous gentlemen, clad in dark coats, making Richard Wagner responsible for the lost war, exhaust themselves in all kinds of propositions. While one side propagates an international foundation . . . the other side wishes to open the Festival Playhouse to innovators of tune, who have lost their reputation during the Third Reich. All in all some grievous pictures of human natural history." I do not think I can quote any more from this document.

But I would like to cite one more incident before turning to the positive side of Bayreuth. It was the Festival of 1955. From my table in the restaurant, I had a fine view of a long table for eight or ten people which was



attracting considerable surreptitious attention. The table stood lengthwise from the windows to the main aisle, and at one end, away from the aisle, sat a bespectacled old man with a turtle's neck and face. The headwaiter saw to it with obsequious punctilio that the champagne glasses there were kept filled, and the party seemed a gay one. Down the aisle, coming from the direction which the old man faced and walking with unusual deliberation, was a steady promenade of elegant Germans and their ladies, their faces straight ahead but their eyes turned unobtrusively towards that place by the window. Every now and then, the old man would glance up and give the merest flicker of recognition. Whenever this happened, the in-

dividual so honored would bow from the waist, almost ludicrously low, and his lady would all but dislodge her head by way of greeting. The old man was Hjalmar Schacht, who, as the man who persuaded the all-powerful *Industrieklub* to allow the upstart ruffian Hitler to speak to them, had been personally responsible for lining up the big Ruhr industrial fortunes behind the Nazis, marking the turning point in Hitler's political rise, and who as Finance Minister had been the wizard who kept Hitler's war machine oiled and running.

Responsible journalism requires that a certain leaven of constructive criticism accompany any such attack as I have mounted here, but where the Bayreuth audience is concerned I am at something of a loss. The Festival can hardly be expected to screen its ticket buyers—although it assuredly might jack up its editorial scrutiny. It might also keep a sharper eye on such peripheral matters as its menu covers. (In all fairness, Papen was the only such lapse to attract my attention, and his picture was gone the next year.) The Bayreuth audience is a sociological phenomenon of West Germany today, like it or not. As long as Prof. Theodor Heuss was Federal President, no amount of finagling could persuade him to go to Bayreuth, although official circles there tied themselves into double bowknots. It is true that Heuss had absolutely no interest in music; but sources close to him say his main reason was disinclination to exchange any ceremonial handshakes with Winifred Wagner or her sons, one of whom gave Adolf Hitler's nickname Wolf—the name by which all Winifred Wagner's children knew Hitler, and knew him well—to his own son.

If the Festival does not court this audience, its prices indirectly do—the best seats cost almost \$15 and the cheapest about \$2.50, and such prices in Germany eliminate all but a certain economic level which happens to be the one heavily burdened with responsibility for, and intricately connected to, the political past. From the standpoint of status and snobbishness, the annual opening performance is the one to be seen at, with the first *Ring* cycle a close runner-up. After that, the real music lovers come, and the difference in audience atmosphere is appreciable. And, from the practical standpoint, even that poisonous opening-night crowd is easily enough avoided by eschewing the restaurant in favor of the more humble cafeteria-style place on the other side of the Festspielhaus.

Berthold Beitz, the outspoken gentleman who is Alfred Krupp von Bohlen's right-hand man, was quoted some time back as saying, "If you want to make connections and do business with German industry, you have to go along with the Bayreuth thing. There you've got the whole pack all together at one time." If your interests are sociological as well as musical and you want to see who's running West Germany today, go look at that opening-night audience at Bayreuth, and look hard.

# FREE BOOKLET

on the technical  
and performance  
specifications of

# THE NEW SCOTT

stereo speaker systems\*

Write today for your copy of this new booklet on SCOTT "Reflection Coupler"\* Stereo Speaker Systems. It contains information on performance and installation that is not available on any other Speaker System. For example, it shows the response of the SCOTT System not only under controlled laboratory conditions, but also at 10 different points in a typical living room location.

You'll find this booklet  
a mine of unique  
and useful information.

\*Patent Applied For

Write Dept. C-1

# SCOTT

SCOTT RADIO LABORATORIES, INC.  
241 West Street, Annapolis, Md.

"The Sound of SCOTT Is the Sound of Music"  
CIRCLE 107 ON READER-SERVICE CARD

# trading?

## audio exchange makes the BEST Trades!\*

\* See HIGH FIDELITY Magazine,  
May 1959, page 39

We have the franchise  
for these exclusive  
manufacturers



- PROMPT SERVICE
- LARGEST SELECTION  
of guaranteed used equipment
- TRADE BACK PLAN

—write for details

Write Dept HF-4 for our unique Trade-Back plan and Trading information.



## audio exchange

Registered Component Dealers



The Hi Fi Trading Organization  
153-21 Hillside Ave., Jamaica 32, N.Y.  
Closed Mondays • Parking at all stores  
Branches:

Brooklyn . . . . .1065 Flatbush Ave.  
White Plains . . . . .203 Mamaroneck Ave.  
Manhasset . . . . .451 Plandome Road

CIRCLE 16 ON READER-SERVICE CARD

## THE JAZZ DILEMMA

Continued from page 71

of Jelly Roll Morton, one of the most show-biz-drenched of all jazz musicians. Overseas, the English branch of the purifiers has produced such comments as Charles Fox's accolade for Miles Davis: "How splendid to find him kicking showmanship out of the window."

Such pronouncements may be the result in part of the problems involved in developing a new field of criticism, a field that is still so young that no standards of approach or purpose have yet been established. Musicians, as a rule, find the idea of commenting on jazz rather strange.

"Nobody can talk about jazz," Ornette Coleman said recently, voicing a thought common among his fellow musicians. "You play it, you feel it, and it's a very private thing."

Bill Evans, a pianist who is widely admired by the "art" wing of jazz, recalls that when he was twenty-two he had never thought of talking about jazz. "I was playing in Chicago then," he recalls, "and a disc jockey called me up and asked me to be on a radio panel on jazz. I was reluctant to go because I thought I'd have nothing to say. Since then, simply as a social grace, I've deliberately tried to develop an ability to talk about jazz."

The fact that a writer has to think up something to say if he is going to write about jazz may be one of the primary causes for the stress laid on jazz as "art." At least this is the view of Orrin Keepnews, a trenchant jazz writer of long standing who writes too infrequently these days because, as artist and repertoire head of Riverside Records, he is kept busy creating records for other writers to write about. "This emphasis on jazz as an art form may simply be a growing pains stage of jazz criticism," Keepnews declares. "Before the War, writing on jazz was not as pretentious as it is now. Today's writers have a tendency towards hyperseriousness. Such things as the 'art form' approach are produced by the need to verbalize about jazz. But the trouble with this approach is that when it gets out of hand it limits the kind of jazz you can write about. There isn't very much you can say about a single blues chorus, for example, but that does not make it any less valid a jazz expression than something on which you can verbalize for page after page."

Most musicians perform jazz as entertainment, Keepnews believes, and are not concerned with the either/or strictures of art vs. entertainment posited by writers. He feels it is entirely possible for jazz to be—quite comfortably—at once art, entertainment, and a commercial success. He cites the Modern Jazz Quartet as an instance.

And he raises a couple of questions that might give pause to both the anti-entertainers and the pro-showmanshipites:

Granted that Louis Armstrong is probably pulling people's legs now, is he any more of a clown in his way than Sir Thomas Beecham is in his?

Is Miles Davis really a deliberate showman? "Nobody gives Miles credit," Keepnews says, "for developing what may be the greatest publicity gimmick since Erich von Stroheim was 'The man you love to hate.'"

Intriguing as the notion of Armstrong as the jazz Beecham may be, or of Davis as a craftily disguised Madison Avenue mind, the essential point is that they both became public figures not as clowns or publicists but as jazz musicians. And whether the jazz musician should be exclusively artist or exclusively entertainer depends on one's concept of jazz itself. If one views as the ultimate goal for jazz the rejection of everything connected with its early stages of growth, the scourging of the appeal to the heart in favor of appeal to the head, and the encouragement of the idea that jazz is an esoteric and highly complex means of expression, then jazz may certainly become a dry and drab art form. Similarly, if the merit of jazz is to be decided by the size of its audience, if the lowest common denominators of appreciation are permitted to set a ceiling on what can justifiably be considered jazz, it will be reduced to the most banal and shallow type of entertainment. In both cases, the future for jazz would be bleak and, undoubtedly, brief.

But the fact is that jazz would no longer be jazz if it went in either of these directions. The distinguishing characteristic of jazz has always been that it is neither a "serious" music, to be endured because of its supposed cultural values, nor, on the other hand, pop pap designed to fill a mass mental and emotional vacuum. It has—and must continue to have if it is to retain its identity



—a unique mixture of emotional vigor and intellectual excitement that is the product of an artist (actually a group of artists because a community of creativity is inevitably involved in producing jazz) whose work engages the listener's mind and emotions and moves him to joy, suspense, or awe.

Is this entertainment? Unquestionably. Is it art? Necessarily.

It is something of both. Without one or the other, it is nothing. And among the contributing elements that keep both these factors in balance are certain proven "show biz" precepts, one of which is that no audience worth playing to can be either patronized or snubbed.

## FM'S NEXT CHAPTER

Continued from page 51

is not uncommon to find a transmitter in trim shape, but the equipment for playing records, which comprise the bulk of most stations' programming, of so-so quality and condition, often distinctly lower than many a home high-fidelity installation.

FM should of course be given credit for quickening the growth of a new type of non-mass, semipopular culture. FM's luminaries differ sharply in temper and personality from the myth-heroes who populate the channels of AM and TV. They include scholars such as Gilbert Highet; anthropologists such as Ashley Montague; music critics such as David Randolph; maverick classical disc jockeys such as Skip Weshner. Even the general run of products and services sponsored on FM has a refreshing variety: instead of toothpaste, books; instead of breakfast foods, European travel; instead of cigarettes and soap, sports cars and record albums. And the sell is definitely soft; the haranguing announcer and the singing commercials have given way to a kind of reasonable persuasion and the aural decoration of neatly turned arrangements of musical passages readily recognizable as "serious" or "classical."

Yet, the margin for error, for "bloopers," shows no sign of narrowing. On any day and on almost any station you are likely to hear turntable wow, tape decks running at wrong speeds, miscued records, sudden interruptions with no explanation, scraping of tables or chairs. Significantly enough, the major stations commit these bloopers as often as do the smaller ones.

Finally, despite FM's impressive advances, it still has not gained even comparable recognition with AM radio and TV. For instance, most newspapers slight complete FM schedules and the program guides published by individual stations only partially fill this lack of coverage. The general difficulty, of course, is confusion of quantity with quality, and an attendant preoccupation with big numbers, big names, big networks, big pressures, and so on. This problem involves the juxtaposition of high quality broadcasting via FM—mono or stereo—against anything else on the broadcast and TV bands.

The FM broadcast band is, of course, 88 to 108 megacycles, a fraction of the wider television spectrum (54 to 215 mc) of which it is a part. FM's 20 megacycles thus takes on a less than overwhelming significance from a strictly numerical point of view. Despite the fact that some of the best programming takes place on FM, those 20 megacycles retain, in the eyes of many, merely a one-to-eight relationship to the larger TV band. Add to this the obvious fact that the remainder of that band, occupied by commercial TV, is more lucrative and

Continued on next page

## What in the world is going on— at this moment?

The best-informed people depend on their own Hallicrafters short wave receiver for news of the world's great events—straight from the source—while it is happening.



Professionally-styled Hallicrafters SX-62A, \$395.00. Four short wave bands plus FM and AM broadcast. Other fine receivers from \$59.95—sold through selected suppliers of professional radio equipment. Names on request.



Hear dramatic examples on "The Amazing World of Short Wave Listening"—limited edition recording. Please send 25c to Hallicrafters, Dept. 16, Chicago 11, Illinois.

**hallicrafters**  short wave radio

CIRCLE 58 ON READER-SERVICE CARD

## THE GRAMOPHONE

"THE GRAMOPHONE" IS TO BRITAIN AS  
"High Fidelity" IS TO AMERICA.



A specimen copy will be sent free, on request.

- ★ Authoritative Record Reviews
- ★ Interesting and Informative Articles
- ★ Technical Reports

"The Gramophone" is available by Annual Subscription \$4 which can be remitted by International Money Order or Personal Dollar Cheque to:

"The Gramophone"  
Subscription Department (2),  
49 Ebrington Road,  
Kenton, Harrow,  
Middlesex, England.

"THE GRAMOPHONE" also publish quarterly the  
LP CLASSICAL and POPULAR RECORD CATALOGUES—  
Annual Subscriptions \$3 and \$1.50 respectively

CIRCLE 55 ON READER-SERVICE CARD

and, for your shelf...



# The new Z-400

... incorporating in one small cabinet the much recommended JansZen® Electrostatic providing the mid and upper frequency tones and overtones which make High Fidelity (with or without stereo) a fact instead of fancy—with our Model 350 woofer.

This woofer produces a bass definition and clarity coupled with an over-all BIG SOUND seldom, if ever found in "the others," from \$134.50

... send for literature

**NESHAMINY ELECTRONIC CORP.**

Neshaminy, Penna.

\*including designs by Arthur A. Janszen.

CIRCLE 66 ON READER-SERVICE CARD

## PURCHASING A HI-FI SYSTEM?

TIME PAYMENTS AVAILABLE  
Up to 2 years to pay!

Send Us Your List of Components For A Package Quotation

YOU CAN BUY WITH CONFIDENCE AT AIREX

All merchandise is brand new, factory fresh & guaranteed.

FREE Hi Fi Catalog Available on Request

**AIREX RADIO**

CORPORATION

85-HF Cortlandt St., N. Y. 7, WO 4-1820

Jim Lansing®  
Altec Lansing  
Electrovoice  
Jensen•Hallcraft  
Hartley® • Gonset  
USL Citizen Band  
Texas Crystals  
University  
Acoustic Research  
Janszen • Viking  
Wharfedale  
Concertone  
Bell • G.E.  
Weathers  
Harman-Kardon  
Eico • Pilot  
Sherwood®  
Tandberg®  
ESL  
Superscope  
Dual Changer®  
Bogen • Leak  
Dynakit • Fisher  
H. H. Scott  
Thorens®  
TEC • Roberts  
De Wald  
Sony • Challenger  
Wollensak  
Garrard  
Miracord  
Glases-Steers  
Rek-O-Kut  
Components  
Norelco • Conrac  
Fairchild  
Pickering • Gray  
Audio Tape  
Magnecord®  
Rockford Cabinets  
Artisan Cabinets  
• Fair Traded

## FM'S NEXT CHAPTER

Continued from preceding page

capable of exerting far greater pressures, and it is small wonder that while the FCC will spend billions on furthering TV, far less is allocated for FM improvement and such a question as FM stereo via multiplexing can be pushed aside apparently indefinitely.

Last winter's Landis report to then President-elect Kennedy characterized the FCC as an "extraordinary spectacle." This agency, said Landis, "despite considerable technical excellence on the part of its staff . . . has drifted, vacillated, and stalled in almost every major area. It seems incapable of policy planning, of disposing within a reasonable period of time of the business before it, of fashioning procedures that are effective to deal with its problems." Of course not all of the FCC merits such criticism for all of its actions. Indeed, it seems that what is at fault here are not the aims and purposes for which the FCC was established, but certain shortcomings in its attempts to realize those goals. In any case it might be well if the whole area of FM broadcasting were turned over to a new and separate body within the FCC, one that is free, mentally, of the questionable ties-by-association to the mores of AM and TV broadcasting.

Such a new bureau would not necessarily be composed of "hi-fi bugs" (a kind of lumpen-aristocracy that exists in the minds of FCC officials as a vague annoyance and distraction). but of persons taking a serious approach to the technical rigors and cultural integrity represented by FM at its best. No one would gain were FM to slip back into another slump. Everyone would gain if it were nurtured and expanded, a growth which includes, of course, its gaining its stereo voice. This becomes more than a matter of intra-industry squabbling over system A or system B of multiplexing; it is a matter of to what ends and in what way our major natural resource shall be used as a medium for communication and entertainment. It also is a test, in the long run, of whether Beethoven is at least as important to America as Michael Shayne.

Other Hi-Fi Components as low as

**74.95**

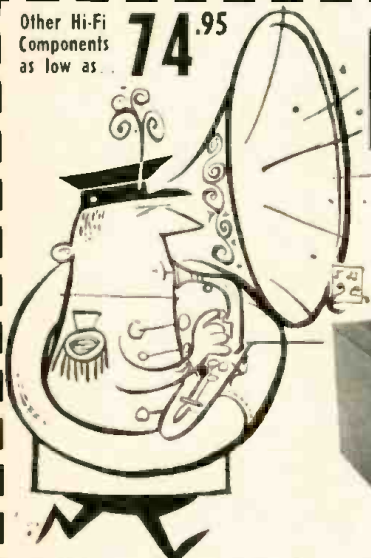

# DEWALD

UNCOMPROMISING QUALITY AT A PRICE!



Model P-1400—Only

**99.95**

AUDIO-PHILE NET

(CASE INCLUDED)

"You Never Heard It So Good!"

35 Watt Stereo-Monaural Amplifier — 17½ Watts Per Channel

- Frequency Response: 20-20,000 CPS plus or minus 1 DB
- Harmonic Distortion Less Than 1% at Rated Output
- IM Distortion Less Than 2%
- 4 EL84 Tubes in Push-Pull
- Dual Concentric Separate Bass and Treble Controls
- Clutch-Operated Volume-Balance Controls
- High Sensitivity for Use With New Stereo Cartridges
- Variable Blend Control Eliminates Exaggerated Channel Separation

OVER 35 YEARS OF DEPENDABILITY!

EXPORT DEPT.:  
25 Warren St.  
New York, N. Y.  
Cable Address:  
SIMONTRICE

In Canada:  
L. J. BARDWELL CO.  
Box 142—Station D  
Toronto 9, Ontario

**DEWALD**



A DIVISION OF

UNITED SCIENTIFIC LABORATORIES, INC.

35-19 37th Ave., Long Island City 1, N. Y.

CIRCLE 39 ON READER-SERVICE CARD

Free!

ILLUSTRATED BROCHURE ON REQUEST

GIVE AT THE SIGN OF THE RINGING BELL



## EX-CLAUQUEUR

Continued from page 55

manifestations of enthusiasm were forbidden by the police. The fact that the prima donna herself had paid for the flowers didn't diminish our admiration for the brave bearers.

A fine touch of drama was added by the fearless management of the State Opera, which sometimes put on a sensational performance in which the famous, feuding divas were singing against each other. (Mr. Bing, despite occasional flashes of courage, has never dared to let Mme. Callas and Mme. Tebaldi sing against each other, say in *Turandot*.) But Mme. Jeritza and Mme. Lehmann did appear together in *Carmen*, *Walküre*, *Rosenkavalier*, *Ariadne auf Naxos*, *Frau ohne Schatten*. Sometimes the great coloratura prima donna Selma Kurz was also in the cast (and having fights with everybody), and the famous mezzo Maria Olszewska was another formidable foe,



ably supported by her husband Emil Schipper, the great bass-baritone. On such nights the Staatsoper was filled with as much tension as Yankee Stadium before a world's heavyweight championship fight. One particularly memorable performance of *Rosenkavalier* took place on the evening of April 25, 1928. Lotte Lehmann (Marschallin), Maria Jeritza (Octavian), Elisabeth Schumann (Sophie), and Richard Mayr (Ochs) were all in the cast. For reasons that cannot yet be divulged—most of the claque's intimate history is still strictly classified information—the claque in those days supported Mme. Lehmann, while the Stieglitz clique worked for Mme. Jeritza. Both groups rooted for Richard Mayr, who never paid a nickel and was, as Schostal pointed out, everybody's honorary client. The boulevard press had hinted that there might be trouble that night, and the police had sent a large detachment of plain-clothes men whom everybody recognized at once. In the downstairs lobby, where Schostal was surrounded by the entire membership of the claque, a warning sign had been put up, "All Disturbing Manifestations of Approval and Disapproval Are Prohibited." (The sign was as effective as the notice appearing on the Met's programs, "The audience is respectfully, but urgently, requested not to interrupt the music with applause.")

The situation was tense. *Rosenkavalier* was a "difficult" opera for the claque. Applause was possible only at the end of each act, and we knew that the clique would desperately try to outshout and outclap us. "Men, the honor of our institution is at stake," Schostal said solemnly.

I will not go into details of the performance, which was spiced by the won-

Continued on next page



Listeners'  
Choice



*Revere*  
**STEREO**  
RECORDING & PLAYBACK  
TAPE RECORDER

Newest 4-Track! Thinline! Lightweight!

**HEAR IT!** Revere is the soundest investment in tape recorders! Makes tapes of stereophonic music from stereo broadcasts and stereo records. Compatible with all 2 and 4-track pre-recorded tapes. Reproduces magnificent stereo sound by connecting directly to your radio, TV or hi-fi. Tapes monaurally and plays as long as 8 hours on a single reel. Use it as a public address system—8 full watts of power! Thinline, lightweight, only 25 lbs.; carry it anywhere. Ask your Revere dealer for a free demonstration of the Revere T-2200 Stereo Recorder or the T-2000 2-track monaural model—both moderately priced.

REVERE CAMERA COMPANY, CHICAGO 16, LOS ANGELES 7

CIRCLE 96 ON READER-SERVICE CARD

## A GRANCO FIRST!



Add the beauty in sound of Granco FM to AM car radio in a marvel of minutes. Superb quality—with Automatic Frequency Control... compact design—only 1¼" thick... and ease of installation make this Granco innovation a "must" for every car owner, especially at this low, low price. Available at radio and auto accessory shops everywhere. **ONLY \$49.95**

WRITE FOR FREE LITERATURE



**GRANCO** America's Leading Specialist in FM

DIVISION · DUMONT EMERSON CORPORATION, Dept. H, 680 FIFTH AVENUE, N.Y. 19

CIRCLE 56 ON READER-SERVICE CARD

# FOR STEREO ONLY!

the cartridge designed to meet the most stringent professional requirements. 0.52 mil diamond stylus; frequency range 20 to 20,000 c.p.s. \$45



at selected dealers

**BENJAMIN**  
ELECTRONIC SOUND CORPORATION  
97-03 43rd Avenue, Corona 68, New York  
**MIRACORD & STEREO TWIN PRODUCTS**  
CIRCLE 24 ON READER-SERVICE CARD

## SAVE OVER 40% ON HI-FI

Bogen AC-210A-20 W Stereo Amp. . . . \$ 99.95  
Bogen TC-200-A-FM/AM Tuner. . . . 129.95  
Garrard RC-210 Changer & Base. . . . 49.00  
Shure M7D-Diam. Cartr. . . . 24.00  
2-Univ. S-80 3-Way Spk. Sys. . . . 113.90  
All Interconn. Cables. . . . 4.95

"Guide to High Fidelity" regularly 50c—yours FREE when you ask for quotations. No obligation to buy.

Regular Catalog Price . . . . 421.75  
YOUR COST . . . 252.00

You Save over 40% . . . . 169.75

Our policy: "We Will Not Be Undersold." Test us . . . send for quotations on package or single components. **FREE WHOLESALE CATALOG.**

### HI-FI RECORDING TAPE

7" Spools - Splice Free - Freq. Resp. 30-15KC

		3-11	12-23	24 & Up
12A	1200' Acetate	\$1.29	\$1.17	\$ .99
18A	1800' Acetate	1.79	1.59	1.45
18M	1800' Mylar	2.09	1.99	1.85
24M	2400' Mylar	2.99	2.69	2.49

Any assortment permitted for quantity discount. Add 15c per spool postage. 10c 24 or more.

**PRE-RECORDED TAPES—RCA-VICTOR, BEL CANTO 2 & 4 Track.** Write for Complete Catalog FREE, and Wholesale Discounts.

JR. TAPE SPLICER Reg. \$6.50 Special \$2.95  
DELUXE TAPE SPLICER " 8.50 " 3.95



"The House Of Low Low Prices"  
220-A East 23rd St., New York 10, N. Y.  
CIRCLE 64 ON READER-SERVICE CARD

## EX-CLAUQUEUR

Continued from preceding page

derful rivalries on stage. As the curtain went up, I remember the Marschallin sitting stiffly at one end of her couch, while her ardent lover Octavian was crouched at the other end. In spite of the orgiastic music of the Prelude, there was no evidence that the Marschallin and Octavian had had an interesting night together. The whole opera was noteworthy for the supreme skill with which the various divas outmaneuvered each other. At the end of each act there were "wild outbursts of uncontrolled enthusiasm" in which everybody took part, even the plain-clothes men.

During the last intermission I noticed that Schostal met the *Hohlposcher* at Frau Piebitz's stand near the fountain where several flower bouquets had been soaking. (Frau Piebitz, the *Wasserfrau*, sold excellent Viennese spring water and the so-called *Mailänder*, small chocolate cakes which Schostal distributed as a bonus after successful ovations.) At the end of the performance the *Hohlposcher* made a dramatic dash downstairs but were stopped from throwing their flowers by the intervention of several clique characters who, somebody said, were usually active around the locker rooms of Sportklub Rapid, a soccer team famous for the rough manners of its *aficionados*. In the ensuing scuffle one of the flower bouquets hit the face of Richard Mayr, who threw it right back into the audience. The *Hohlposcher* and Rapid fans were arrested.

The rest of us ran to the stage doors where we created such a tumult that some guests at the nearby Hotel Sacher asked for their bills because they thought that another revolution had broken out. The plain-clothes men, who had taken



part in the ovation, waited with customary thoughtfulness until the divas had departed and then arrested the entire membership of clique and clique.

Everybody was marched off to the police station, where Stieglitz and the clique members were fined for disturbing the peace. Schostal and the claque members were dismissed with assurances of mutual esteem. The police knew that the claque was motivated by artistic motives. In Vienna a real opera fan could do no wrong. The next evening Schostal went to Frau Piebitz's fountain up in the gallery and bought each of us a *Mailänder* and a glass of water.

## Trader's Marketplace Classified Advertising

# ORDER FORM

Fill in coupon below and mail, with check or money order (no cash). Rates 45c per word with no charge for name and address. Print or type your ad below.

**HIGH FIDELITY MAGAZINE**  
Great Barrington, Massachusetts

\_\_\_\_\_  
\_\_\_\_\_  
\_\_\_\_\_

- Next issue only  
 Next 3 issues  
 Next 12 issues  
\$ . . . . . Payment Enclosed

NAME . . . . .  
STREET . . . . .  
CITY . . . . . ZONE . . . . .  
STATE . . . . .

## DAMNED KNOB

Continued from page 62

The chief recording engineer for AFG, on the other hand, achieves what many, including myself, conceive as a more natural sound, although the interpretation here of the andante is less subtle if more restrained . . ." etc.

Or consider the record with exaggerated stereophonicity. This has several advantages: it is dramatic on a high-fidelity system and some of the stereo effect will be forced through on low-fidelity stereo equipment. If some don't like the exaggeration, it can be counteracted fairly effectively by manipulation of the proper controls. Our question remains, however, should we do this? Should we buy a record whose sound we don't like and then trust to our skill at correcting it? Should we listen to an orchestra whose conductor does not know how to keep it balanced? Or go to a concert hall where the acoustics are bad? Obviously we should if there is nothing else available, but there are plenty of records for every taste.

While these may be highly valid reasons for eliminating knobs, we suspect, alas, that we won't get very far with the idea. As has been said so often, much of the fun of owning a high-fidelity rig is derived from participating in the recreation of the music. How much we should participate—ah, that's the question—for the next decade.

**AMPEX CONCERTONE**, Magnecord, Presto, Tandberg, Bozak, Citation, E.M.I., Grado, Scott, Sherwood, Thorens, others. Trades. Boynton Studio, Dept. FH, 10 Pennsylvania Avenue, Tuckahoe, N. Y.

**SELL:** Cook BN Preamp-Livingston arm, two G.E. Diamond cartridges, twin track records, \$100.00. Den Denson, P. O. Box 122, Rockville, Conn.

**STAN WHITE 4 D Theater speaker system.** List, \$1500. Like new condition—sacrifice price. Make an offer. P. O. Box 67, Corona 68, N. Y.

**NEW METALIZED MYLAR TAPE** for recorder with automatic stop or reverse. Norelco, Wollensak, Tandberg, Uher, Grundig, DeJur. PS adhesive, non-abrasive, 1 mil. Quantity discounts. 1/8" & 1/4" widths. Postpaid \$1.25 roll. EL Products, Box 771-B, Havertown, Pa.

**INDUCTORS FOR Crossover Networks.** 118 types in stock. Send for brochure. C & M Coils, 3016 Holmes Ave., N.W., Huntsville, Ala.

**PROFESSIONAL RECORDING TAPE.** First quality of prime manufacturer. Full frequency response. Polished. Lubricated. Money back guarantee. Acetate-1200', 1 1/2 mil, 4/5.00; 1800', 1 mil, 4/6.65. Mylar-1200', 1 1/2 mil, 4/5.84; 1800', 1 mil, 4/8.20; 2400', 1/2 mil, 4/12.60. Postage 20c each reel. HiSonic, 1212 North Park Road, Hollywood, Fla.

**STEREO TAPES:** New-used; 2-4 track. Free list. Steven Keller, 8057 Fayette Street, Philadelphia 50, Pa.

**GERMAN RADIO and Sound Equipment, Service and Parts.** Eurotech Service Company. 93-08 Corona Ave., Elmhurst 73, N. Y.

**LEONARD WARREN TAPE** Recordings wanted. John F. Leppert, College of St. Thomas, Box 1223, St. Paul 1, Minn.

**50 ISSUES HIGH FIDELITY, 1956-'7 complete.** Alfred Cho, 2901 Covert, Fort Worth 15, Tex.

**EUROPEAN FESTIVAL TOURS,** varied itineraries, free time; informative, thrilling, ninth year; congenial adults, taping, photographing; First Class, Cartan Travel. See agent, or request Folder NOW. Dr. Sterling Wheelwright, San Francisco State College, San Francisco 27-H, Calif.

**LOW PRICES ON STEREO COMPONENTS,** Tape Recorders and tape. We accept trades. Write for quotation. C. M. Sales, Box 140, Simpsonville, Maryland.

**SALE: 78 R.P.M. RECORDINGS, 1902-1950.** Many types. Free lists. Collections bought. Mr. Ellie Hirschmann, P. O. Box 155 (HF), Verona, N. J.

**FOR SALE: STEREO PAIR,** Jim Lansing 34001 two-way speaker systems. 130A driver, 175DLH tweeter and acoustic lens, N1200 crossover. Oak with beige and gold grill cloth. Condition: Like New. Price, \$495.00 FOB Baton Rouge, La., J. M. Edelman, M.D. 700 Commerce Bldg., Baton Rouge, La., DI 2-6801.

**YOUR INQUIRIES INVITED.** Authorized distributors. Professional service. F.T.C. Brewer Co., 1714 N. Pace Blvd., Pensacola, Fla.

**RARE 78's.** Write Record-Lists, P.O. Box 2122, Riverside, California.

**PROMPT DELIVERY,** We will not be undersold. Amplifiers, tape recorders, tuners, etc. No catalogs. Air Mail quotes. Compare. L. M. Brown Sales Corp., Dept. F, 239 E. 24th St., New York 10, N. Y.

**ALL MAKES HIGH FIDELITY speakers repaired.** Amprite, 16B W. 23rd St., New York 11, N. Y. CHelsea 3-4812.

**PRECISION RECEIVER ALIGNMENT—FM—S5; FM/AM—S9.** HiFi equipment meticulously serviced. Kit problems solved. I. Pollack, Westbury, L. I., N. Y. ED 4-4490.

**COMPONENTS, RECORDERS, Tapes.** Send for wholesale catalogue. Carston, 215-A East 88th Street, New York 28, N. Y.

**WANTED:** Altec-Lansing 820A corner system in cabinet. Karl Riemer, 397 Nahatan Street, Westwood, Mass.

**DON'T BUY HI-FI components, kits, tape, tape recorders** until you get our low, low return mail quotes. "We guarantee not to be undersold." Wholesale catalog free. Hi-Fidelity Center, 220AC E. 23rd St., New York 10, N. Y.

**RECORDS IN CHAOS?** Let us show you how our Record Index simply and handsomely solves the problems of arranging and indexing your records. Brochure indicates solutions to ten aesthetic and practical problems of the serious collector. Sample Record Index cards included. About 5¢ to 8¢ per record. Recocards (H14), 503 Hyde Park Bank Building, 1525 East 53d Street, Chicago 15, Ill.

**EXCELLENT QUALITY RECORDING TAPE—7"** reels. 30-15000 cps guaranteed. 1800' Acetate, 3/5.10-6/10.00; 1800' Mylar, 3/6.60-6/13.00. SPECIAL, 2400' Mylar, 3/7.20-6/14.25. Plus 15c PP & Handling per reel. Foto Sound, 88 Harbor Road, Port Washington, N. Y.

**HARPSICHOIDS, CLAVICHOIDS—Excellent modern German instruments** by Sperrhake. Beautiful cabinetry, moderate prices. Robert S. Taylor, 8710 Garfield Street, Bethesda, Maryland.

**AMPEX—FISHER—LEICA:** Ampeg 601, 960 recorders, 620 speaker-amplifier; Fisher amplifier, preamp, tuner. Excellent or unused. Big reductions. Scotch tape bargains. Leica camera with projector, dirt cheap. List for 25c. Foster Gunnison, Suite 806, 600 Asylum Ave., Hartford, Conn.

**FOR "HARD TO GET" records—all speeds—try our Rare Records Department.** Record Exchange, 812 Seventh Ave., New York 19, N. Y.

## TRADER'S MARKETPLACE

Here's the place to buy, swap, or sell used equipment, records or what have you. Rates are only 45¢ a word (no charge for name and address) and your advertisement will reach more than 110,000 music listeners. Remittance must accompany copy and insertion instructions. Copy must be received by 5th of 2d month preceding publication and is subject to approval of publishers.

**TAPE RECORDERS, Hi-Fi components,** Sleep learning equipment, tapes. Unusual values. Free Catalog. Dressner, 1523A Jerricho Turnpike, New Hyde Park, N. Y.

**RENT STEREO TAPES—over 2,000 different—all major labels—free catalog.** Stereo-Parti, 811-D Centinela Ave., Inglewood 3, Calif.

**WRITE FOR QUOTATION** on any Hi-Fi components. Sound Reproduction, Inc., 34 New Street, Newark 2, N. J.

**HI-FI PROBLEMS SOLVED** on-the-spot by "The Hi-Fi Doctor." Audio, Acoustic, Radio Engineer. Professional visits, day, evening, New York area. William C. Bohn, 550 Fifth Ave., New York City. Plaza 7-8569.

**SPEAKERS—Best Quotations—Sale items.** Bayla Co., Box 131-F, Wantagh, N. Y.

**WANT Fisher AM Tuner,** Lansing tweeter. J. C. Cosgrove, 1333 Dell Cove Dr., Fort Wayne, Ind.

**JENSEN KT-32 speaker system** in original carton, \$132.00. Nelson Hazeltine, 905 Jefferson Rd., Fostoria, Ohio.

**FOR THE VERY BEST** in tape rentals at lowest prices. The Stereo Shop, 330 California Ave., Palo Alto, Calif.

**ROBERTS TAPE DECK 190D4,** 4-track, perfect, cost \$169.00, sacrifice, \$89.00. British Ferrograph two speed monaural, 3 motors, excellent, cost \$350.00, sell \$89.00. Earl Roberts, 650 N.E. 97 Street, Miami Shores, Fla.

**SELL:** Janszen 1-30 mahogany, Fisher BOC, AR-1 mahogany, Heathkit W-6M, all excellent. C. S. Kline, 90D2B Knight Street, Laughlin AFB, Del Rio, Tex.

**TANDBERG,** stereo, model 5-2, 2-track, only 20 hours of operation. Best offer. Colonel A. G. Pixton, Headquarters, 26th Artillery Group, Fort Lawton, Seattle, Wash.

**"HEAR IT AT HOME" Program.** Take any disc or tape . . . Free. DRC—Definitive Recordings Club, 11024 Magnolia Blvd., North Hollywood, Calif.

**AMPEX—A-692,** amplifier, loudspeaker, used 20 hours, \$100.00. Gene Shavlani, 543 Alden Drive, Rahway, N. J.

**HIGH FIDELITY, 1-100.** Best offer. Frank Mack, 6607-4th Avenue, Sacramento 17, Calif.

**COLLECTORS Cetra sets** for sale. William Tell, Ernani Pasquale, Sonnambula, etc., G. O. Moran, Box 83, Lodi, Wis.

**OUT-OF-PRINT LPs.** Classical Record Shop, 825 Seventh Avenue, New York 19, N. Y.

**HIGH QUALITY Teflon 600 volt electronics 22 hookup wire.** Insulation cannot melt from soldering iron. Used by missile, aircraft and electronics equipment. 25 feet each of two colors, \$1.00. Box 502, Westbury, N. Y.

# Free Offer!

(see below)



CHAMPAGNE  
TASTE?  
BEER  
INCOME?

IF you love Hi-Fi...

and have unlimited taste but limited income, Rabsons (established 1905) is the happy answer to your problem. We've been in hi-fi since its infancy... we handle the finest American and Imported lines, top quality names... the equipment you're drooling for. Here you are dealing with a reliable, long-established responsible firm that enjoys a world-wide reputation for integrity. We have a big beautiful, well-stocked street level floor (diagonally across the street from famed Carnegie Hall and proudly serve many of its top-name musicians who know good sound). Here is just ONE example of many substantial savings: GRUNDIG (West Germany's finest) HI-FI SYSTEM—AM-FM and SW Tuner, Stereo Amplifier, Automatic Record Changer, Two Stereo-Mate Speakers, Diamond Stylus.

As advertised in LIFE... Audiophile net \$500.

RABSONS' PRICE... \$299

(Descriptive folder on request) F.O.B., N. Y.

YOU can actually see and hear these components—our store is a "live" catalog so why buy from a printed one?

TELL US exactly what you want to buy and get our quotation. You'll be glad you did. Or, tell us what you'd like to spend and we'll suggest one or more "best-buy" hi-fi systems.

FREE—With our quotation we will include a \$1.00 genuine Miracle Record Cleaning Cloth; removes static, cleans and preserves precious records! Enclose 10c to cover mailing cost.

**Rabsons- 57 ST., Inc. Dept. H**  
119 West 57 St., New York 19, N. Y.  
CIRCLE 93 ON READER-SERVICE CARD

save on  
**stereo**  
hi-fi

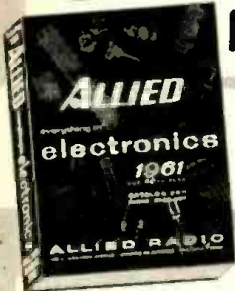

send for the 1961  
**ALLIED**  
CATALOG  
free

SAVE MOST! Here's your complete money-saving guide to Hi-Fi, including products available only from ALLIED. See how you save on our recommended complete Stereo systems. Choose from the world's largest stocks of famous-name amplifiers, tuners, changers, speakers, enclosures, period-style equipment cabinets, tape recorders, accessories; save most with KNIGHT® deluxe components. Build your own—save even more with our exclusive Hi-Fi KNIGHT-KITS®. For everything in Hi-Fi and Electronics, get the FREE 444-page 1961 ALLIED Catalog!

only \$5 down  
on orders  
up to \$200

**ALLIED RADIO**

free

ALLIED RADIO, Dept. 144-D1  
100 N. Western Ave., Chicago 80, Ill.

Send FREE 1961 ALLIED Catalog.

Name \_\_\_\_\_

Address \_\_\_\_\_

City \_\_\_\_\_ Zone \_\_\_\_\_ State \_\_\_\_\_

CIRCLE 5 ON READER-SERVICE CARD

## STOKOWSKI

Continued from page 47

MARSH—Do you ever listen to light music?

STOKOWSKI—Every two or three years I hear jazz that is really creative, vital, completely original, with wonderful interplay of theme and countertheme. I always wish later that I kept a better record of the jazz I have enjoyed. So much jazz playing is simply an imitation of somebody else.

MARSH—I would surmise from your remarks that you have a fairly extensive stereo system.

STOKOWSKI—Yes, in my New York studio I have a complete system for playing stereo recordings, and I renew the equipment as new designs become available. Speakers are the biggest problem. I feel they are the least highly developed of components, while the amplifiers that drive them are probably the most highly developed—except possibly for some modern microphones.

MARSH—What special problems do you see as barriers to the understanding of new music?

STOKOWSKI—It is a matter of ear experience. The mind receives its impressions from the ear. The mind always resists new types of impressions at first. This is both a physical and an artistic fact. After we have had an unfamiliar impression a number of times it suddenly becomes clearer and more significant. New impressions are like being in a forest where there is no track. We feel lost. With familiarity we find a way.

MARSH—You were, I know, a pioneer in introducing the music of Mahler to this country. You conducted the American premiere of *Das Lied von der Erde* in 1916 and the same year you gave historic performances of the "Symphony of a Thousand Voices." What future do you now see for Mahler here?

STOKOWSKI—Mahler is not easy for the average man and woman to understand. He has two great qualities, deep emotion and the love of nature. I feel I know him because I am very sensitive to nature. So many people today fear nature as an enemy. They want to keep the cold and dark out of their lives, so they live in artificial surroundings. They don't walk but take a car. It is part of their defense.

Further, Mahler's music is not easy to perform. It requires much from both the players and the conductor if it is to be a true communication from composer to listener.

MARSH—On several occasions in Philadelphia you attracted national attention by performing the music of Arnold Schoenberg. Were you friends?

STOKOWSKI—Yes, for many years. When Schoenberg finished a score he always sent it to me. I was very interested in his twelve-tone theories, because the first composer who was twelve-tone in spirit was Bach. In his Forty-eight Preludes and Fugues of the *Well-Tempered Clavier* he was writing, for the first time, for an instrument of equal temperament, making it possible to conceive of music in terms of twelve half-steps to the octave. We find many anticipations of twelve-tone devices in music. The opening of the first Beethoven symphony on a chord that belongs to an unexpected key is an example of growing freedom in the use of harmony. Scriabin is often very close to twelve-tone writing.

Schoenberg was a very clear thinker who cared for an idea more than for personal success. He saw that music is in a constant stage of evolution and felt the urge to work out his system.

MARSH—In your concerts at the Edinburgh Festival your programs will contain the *Gurrelieder*, however, rather than a later Schoenberg work.

STOKOWSKI—The *Gurrelieder* is a genuine masterpiece. It is Schoenberg, but it is beautiful music, romantic with wonderful themes. It is not difficult to understand or enjoy.

MARSH—What do you think now about the assimilation of twelve-tone music into the American concert repertory?

STOKOWSKI—If I have the pleasure of meeting you in heaven or hell in two or three hundred years, I shall be happy to answer with a degree of certainty.

MARSH—I am sure, though, that you are gratified to find that—after your pioneering more than twenty years ago—Berg's

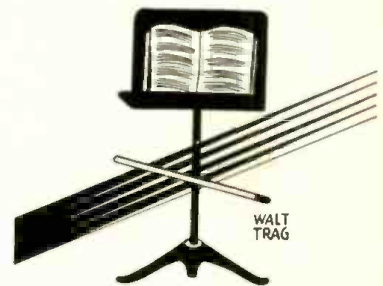

*Wozzeck* is in the current repertory both at the Metropolitan and San Francisco Opera houses.

STOKOWSKI—Naturally. But it has certainly taken long enough!

MARSH—Do you think that from the point of view of a hundred years or more our century will appear to have produced as much great music as the nineteenth?

STOKOWSKI—Certainly. I don't doubt that for a moment. All anyone has to do is to enumerate the great works written since 1900.

MARSH—What do you feel is the most



common error of young contemporary composers?

Stokowski—They feel they must write in obsolete forms. Young men shouldn't write symphonies today. They were natural for Mozart, even Brahms, but we need to create new musical forms that express our period in history. Melody is itself a form, a simple one, of course, but larger forms can be built around it. Bach's principles of form show the eternal meaning of design in achieving unity from variety. We need to think of these first principles rather than any particular application of them, such as the sonata. Without unity expression is lost. Without variety music becomes monotonous.

Ideas create forms. Debussy's *Prelude to the Afternoon of a Faun* expresses a new musical idea that created a new form in which the composer found realization. When the work comes to an end, we have the impression of perfect artistic clarity. This is what we must strive to achieve in today's music.

• CALIFORNIA •



**QUICK-SEE ALBUM FILE**

Eliminates bottom jacket wear. Rolls forward for front-view, flip-through selection. 9 models fit any cabinet, closet or shelf. \$7.95 up. Also available with cabinet shown. Dealers, inquire.

**KERSTING MANUFACTURING COMPANY**  
504 S. Date Street, Alhambra, California  
CIRCLE 69 ON READER-SERVICE CARD

• DISTRICT OF COLUMBIA •

**NORELCO SPEAKERS**

Famous 9177M—successor to the 9110M, twin-cone 8" speaker, original list \$39.95, usual NET \$23.97, NOW, while they last 1/2 off net... \$11.98 plus postage. (Discontinued model.) Frequency 40-20,000 cy. Other SENSATIONAL Speaker reductions on a first come, first served basis. Send for Speaker Specification Sheet. **COMMISSIONED ELECTRONICS CO.** 1776 Columbia Road Washington, D. C.



CIRCLE 37 ON READER-SERVICE CARD

IN WASHINGTON, D. C.  
*Nearly Everyone Buys At...*  
**Myer's EMCO**  
MAIN STORE:  
509 11TH ST., N.W., WASH., D. C.

CIRCLE 85 ON READER-SERVICE CARD

• MARYLAND •

**DIXIE**

**HIGH FIDELITY WHOLESALE**

Largest discount High Fidelity component distributors in the South. Wholesale prices on package or individual components. All latest models in factory sealed cartons.

**Are prices too high?—Write:**

**DIXIE HI-FI**

12402 Connecticut Ave., Silver Spring, Md.

CIRCLE 41 ON READER-SERVICE CARD

**PROFESSIONAL DIRECTORY**

• NEW JERSEY •

**WRITE FOR QUOTATION**  
ON ANY HI-FI COMPONENTS  
**SOUND REPRODUCTION, INC.**  
34 New Street, Newark 2, N. J.  
Mitchell 2-6816

CIRCLE 113 ON READER-SERVICE CARD

• NEW YORK •

FOR THE TOPS IN VALUE  
AND THE BEST TRADE-IN ON  
HIGH FIDELITY EQUIPMENT  
*Check with Arrow!*  
**ARROW ELECTRONICS, INC.**  
65 Cortlandt St., New York 7, N. Y.  
DIgby 9-4730  
525 Jericho Turnpike, Mineola, N. Y.  
Pioneer 6-8686

CIRCLE 10 ON READER-SERVICE CARD

**THE HI-FI SERVICE!**  
90 Day Warranty  
JAMAICA—JA 3-8850  
MANHASSET—MA 7-5737  
BROOKLYN—BU 2-5300  
WHITE PLAINS—WH 8-3360  
The Original Hi-Fi Trading Organization

**audio exchange**  
JAMAICA 153-21 Hillside Ave.

CIRCLE 17 ON READER-SERVICE CARD

**a Note to the Hi-Fi buyer**  
AIR MAIL us your requirements for an IMMEDIATE WHOLESALE QUOTATION Components, Tapes and Recorders SHIPPED PROMPTLY AT LOWEST PRICES  
**AUDIO unlimited** FREE CATALOG  
190-F Lex. Ave., N.Y. 22, N.Y.

CIRCLE 19 ON READER-SERVICE CARD

**SOUND TASTIC!**  
That's what our customers are saying upon receiving our prices! Write for special low prices on all hi-fi components, tape recorders, etc. **INDIVIDUAL QUOTATIONS ONLY!** No catalogs.  
**AUDIO WORLD**  
2057 Coney Island Ave., Brooklyn 23, N. Y.

CIRCLE 20 ON READER-SERVICE CARD

**OUT OF SPACE?**  
You bet we'd be... If we were to tell you All about AUDION's "Out of this World" Hi Fi Values.  
Write for free catalog.  
**audion**  
25-HF Oxford Road  
Massapequa, New York

CIRCLE 21 ON READER-SERVICE CARD

• NEW YORK •

**HI-FI RECORDING TAPE**  
Splice Free (except 2400')  
15 day money-back guarantee  
3+ 12+ 24+  
1200' 7" Acetate ..... \$1.29 \$1.17 \$1.09  
1800' 7" acetate ..... 1.79 1.59 1.45  
1800' 7" mylar ..... 2.09 1.99 1.85  
2400' 7" mylar ..... 3.29 2.99 2.75  
2400' 7" tensilized mylar .. 4.25 3.95 3.75  
Can Be Assorted. Add 15¢ Postage Per Reel.  
10¢ For 24+ Lot Orders.  
HI-FI COMPONENTS TAPE RECORDERS available from wide variety of stock and shipped within 24 hours. Write for free wholesale catalogue. "WE WILL NOT BE UNDERSOLD." Write us and see why.  
**CARSTON**  
125-D East 88 St.  
New York 28, N. Y.

CIRCLE 33 ON READER-SERVICE CARD

**TAPE RECORDERS**  
HI-FI Components  
SLEEP LEARN KITS  
Unusual Values  
FREE 1961 Catalog  
**DRESSNER** 1523 FA Jericho Turnpike,  
New Hyde Park, New York

CIRCLE 42 ON READER-SERVICE CARD

**F & B** Professional Quality  
**RECORDING TAPE**  
Unconditional 25 Year Money-back Guar. IS  
Top-Quality Freq. Resp. 30-15,000 cycles. **GUARANTEED**  
FOR 25 YEARS  
1200 ft. 7" reel.....3 for \$3.89  
1800 ft. 7" reel.....3 for \$5.22  
1800 ft. MYLAR, 7" reel..3 for \$6.59  
2400 ft. MYLAR, 7" reel..3 for \$9.93  
add 15¢ per reel for postage & handling  
**FLORMAN & BABB, Inc.**  
68 West 45th St. New York 36, N.Y.

CIRCLE 52 ON READER-SERVICE CARD

**WINNERS ALL\***  
Be a winner too! Write for our big discount prices on all of your hi-fi needs—and send for our unusual money-saving audio catalog A-12. It's free! \*71,592  
**SATISFIED CUSTOMERS**  
**Key Electronics Co.**  
120 Liberty St.,  
N. Y. 6, N. Y.

CIRCLE 70 ON READER-SERVICE CARD

**TRADE-INS ACCEPTED**  
**SAVE MONEY**  
on High Fidelity Equipment  
Check our prices first on all Hi-Fi and Stereo Equipment. New, fully guaranteed. Prompt service on all inquiries. Write to Arthur Knight  
**TERMINAL-HUDSON ELECTRONICS, Inc.**  
236 West 17th St., N. Y. 11, N. Y. Dep't HF

CIRCLE 119 ON READER-SERVICE CARD

• PENNSYLVANIA •

**LOOKING for LOW PRICES?**  
STEREO TAPE and RECORDERS  
Hi Fi Components  
BUILT 1950 ESTB. 1932  
Send us your list. Free bargain sheet & tape Cat. Brochure best & newest ORGANS.  
**1373 EASTON ROAD, ROSLYN, PENNA.**  
The brand name stereo specialist.

CIRCLE 63 ON READER-SERVICE CARD

# LAFAYETTE PANASONIC

An Integrated  
**STEREO**  
TRANSCRIPTION  
Tone Arm  
& Moving Magnet  
Cartridge with  
Diamond Stylus

**32.50** only  
2.00 Down



**PLUG-IN STYLUS**  
Diamond-magnet assembly  
virtually constitutes a revitaliza-  
tion of the cartridge.

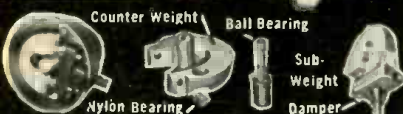

**PERFECTLY  
BALANCED**

Turntable  
leveling  
is not  
critical — tracks  
properly even at  
angles in excess of 45°.

- Completely Compatible
- Signal-To-Noise Ratio Over 100 DB
- Minimum Of Tone-Arm Resonance
- Feather Light Stylus Pressure 3 Grams
- Distortion Free Response From 20-16,000 cps

- Diamond Stylus—Up to 2000 Hours Playing Time
- Hum-Free—Arm & Cartridge Case Shielded With Mu Metal

Meets The Most Critical Studio Requirements  
Integrated design of the cartridge and tone arm provide an exact alignment of the stylus in the record groove—a working relationship that is impossible in conventional units. Arm structure, balance and compliance have been precisely engineered to compliment its superb moving magnet stereo cartridge. Overall arm length is 11 3/4", height is adjustable from 1 3/4" to 2 1/4" for use with any turntable.

**FREE!**

**LAFAYETTE  
RADIO ELECTRONICS**

Dept. WD1-2 P.O. Box 190  
Jamaica 31, N. Y.

- FREE 324-page 1961 Catalog 610  
 PK-448 "Lafayette Panasonic" Tonearm

\$ \_\_\_\_\_ Enclosed

Name \_\_\_\_\_

Address \_\_\_\_\_

City \_\_\_\_\_ Zone \_\_\_\_\_ State \_\_\_\_\_

CIRCLE 72 ON READER-SERVICE CARD

## ADVERTISING INDEX

Key No.	Page	Key No.	Page
1	A.E.S., Inc. 151	67	KLH Research & Development Corp. 6
2	Acoustic Research, Inc. 27	129	Kapp Records 104
3	Acro Products 28	130	Kapp Records 105
4	Airex Radio Corp. 158	69	Kersting Mfg. Co. 163
5	Allied Radio 162	70	Key Electronics 163
6	American Concertone 142	71	Lafayette Radio 4
7	American Stereophonic Corp. 110	72	Lafayette Radio 164
8	Ampex Corp. Back Cover	83	Lansing, James B., Sound Inc. 99
9	Angel Records 100	74	Liberty Records 97
10	Arrow Electronics 163	75	Library of Recorded Masterpieces 119
11	Artia Records 96	73	London Records 106
12	Atlantic Records 136	76	London Records 123
13	Audio Devices 29	77	MGM Records 124
14	Audio Dynamics 8	78	MGM Records 125
16	Audio Exchange 156	79	Marantz Co. 148
17	Audio Exchange 163	80	McIntosh Laboratory, Inc. 21
18	Audio Fidelity 88	81	Mercury Records 91
19	Audio Unlimited 163	82	Minnesota Mining & Manufacturing Co. 12
20	Audio World 163	84	Music Guild, Inc. 108
21	Audion 163	85	Myer's Emco 163
22	Bel Canto 138	66	Neshaminy 158
68	Bel Canto 145	86	North American Philips Co. 26
23	Bell Sound Division 37	87	Opera Magazine 117
24	Benjamin Electric Sound Corp. 160	88	Pickering & Co. 2
25	Bogen-Presto 32	89	Pilot Radio 31
26	Book-of-The-Month Club 5	90	Premier Albums, Inc. 113-116
27	Book-of-The-Month Club 7	91	Professional Directory 163
28	Bozak, R.T., Co. 9		Inside Front Cover
29	British Industries Corp. 80	92	RCA Victor Division 95
30	British Industries Corp. 103	93	Rabsons—57 St., Inc. 162
31	Capitol Records 98	94	Reeves Soundcraft 19
32	Capitol Records 117	95	Rek-O-Kut 36
33	Carston Studios, Inc. 163	96	Revere Camera Co. 159
34	Columbia Records Inside Back Cover	97	Roberts Electronics, Inc. 144
35	Columbia Records 86	98	Roberts Electronics, Inc. 144
36	Columbia Records 102	100	Rockford Furniture 16
	Command Records 109	101	Sarkes Tarzian, Inc. 143
37	Commissioned Electronics 163	102	Schober Organ 18
38	Crosby Electronics, Inc. 22	103	Schwann Catalog 112
39	DeWald Radio 158	104	Scott, H.H., Inc. 23
40	Dexter Chemical 112	105	Scott, H.H., Inc. 24
41	Dixie Hi-Fi 163	128	Scott, H.H., Inc. 25
42	Dressner 163	106	Scott Laboratories, Inc. 154
43	Dynaco, Inc. 152	107	Scott Laboratories, Inc. 155
44	Dynaco, Inc. 153	108	Sherwood Electronic Labs 111
15	Dyna-Empire, Inc. 1	109	Shure Bros. 140
45	EICO 146	110	Sonograf Electric Co. 110
46	Electro-Voice 101	111	Sonotone Corp. 20
47	Fairchild Recording Equipment 94	112	Sony Corp. 122
48	Fisher Radio Corp. 13	113	Sound Reproduction 163
49	Fisher Radio Corp. 14	114	Strand Records 112
50	Fisher Radio Corp. 15	115	Stromberg-Carlson 129
51	Fisher Radio Corp. 17	116	Stromberg-Carlson 131
52	Florman & Babb 163	117	Stromberg-Carlson 133
53	Fortissimo Records 107	118	Tandberg 141
29	Garrard Sales 80	119	Terminal-Hudson 163
54	Grado Laboratories, Inc. 130	120	Thorens 149
55	Gramophone 157	121	Time Records 137
56	Granco Division of Dumont Emerson Corp. 118		Trader's Marketplace 161
57	Greentree Electronics 118	122	United Artists 134
58	Hallicrafters 157	124	University Loudspeakers, Inc. 30
59	Harman-Kardon, Inc. 10	125	Vanguard Recording Society, Inc. 120
60	Harman-Kardon, Inc. 11	126	Vanguard Recording Society, Inc. 121
61	Heath Co. 34	127	Westminster Records 93
62	Heath Co. 35	30	Wharfedale 108
63	HiFi 163		
64	Hi-Fidelity Center 160		
65	International Electronics 33		
66	JansZen 158		

# Attuned To April



**THE VOICE OF SHAKESPEARE**  
SIR JOHN GIELGUD is the true voice of Shakespeare. New—and only on Columbia Records—is the sequel to his "Ages of Man" presentation, a new Shakespeare program titled—"One Man In His Time." Here Sir John goes to the very heart of matters in Julius Caesar, Macbeth, Richard II, Henry V.  
**OL 5550\***



**PHILADELPHIA SOUND SPECTACULAR**  
Rachmaninoff's fiery "Symphonic Dances" are recorded for the first time by the composer's favored ensemble, Eugene Ormandy and The Philadelphia Orchestra. Companion piece is a brilliant orchestration of Paganini solo violin "Caprices," stunningly played by 66 virtuosi—The Philadelphia's string section.  
**MS 6205/ML 5605\***



**BERNSTEIN ON TELEVISION**  
"Humor in Music" is one of Bernstein's most celebrated TV programs, now on records. Along with his enlightening and entertaining discussion of the "game of notes...the sheer joy of perceiving music," Bernstein conducts an exhilarating performance of Strauss' "Till Eulenspiegel." (Other Bernstein TV shows on Columbia **(Lp)**: "What Is Jazz" and "Bernstein on Beethoven.")  
"Once again, Bernstein immeasurably broadened the layman's understanding..."  
Jack Gould,  
The New York Times  
**MS 6225/ML 5625\***



**"CARMINA BURANA"**  
Eugene Ormandy stirs The Philadelphia Orchestra and vast vocal forces into a fever of excitement with Orff's rousing modern setting of rakish medieval verses.  
"For sheer listening pleasure in both a musical and sonic sense, this is one record I'd not pass up on a bet..."  
Hall, HiFi Stereo Review  
**MS 6163/ML 5498\***



**"LIVE" RICHTER CONCERT**  
A great event: Russia's phenomenal pianist Richter, in a "live" concert performance, recorded during a dramatic recital in Bulgaria.  
"The greatest piano performance of the 'Pictures' I have ever heard on or off records..."  
Goldsmith, High Fidelity  
**ML 5600\***



**FRANCESCATTI, FOURNIER and WALTER**  
A joyous alliance in the Brahms Double Concerto.  
"Takes precedence over all other contemporary versions."  
Kolodin, Saturday Review  
**MS 6158/ML 5493\***



**WALTER'S SCHUBERT**  
Newest addition to the treasury of stereo recordings by Bruno Walter, poet of conductors, is his two-volume set of Schubert symphonies—the Fifth, the Eighth ("Unfinished") and the Ninth.  
**M2S 618/M2L 269\***



**STERN, OISTRAKH AND ORMANDY**  
Master violinists Isaac Stern and David Oistrakh unite with conductor Eugene Ormandy in brilliant new recordings of four Vivaldi Double Violin concerti.  
"Among the truly great duet performances of this era..."  
Goldberg, Los Angeles Times  
**MS 6204/ML 5604\***



**BLOCH'S "SACRED SERVICE"**  
Bloch's magnificent "Sacred Service" is recorded for the first time in stereo by Leonard Bernstein, the New York Philharmonic, baritone Robert Merrill and a 40-voice choir.  
"The most compelling choral work of our time..." Biancolli, N.Y. World-Telegram & Sun  
"Bernstein conducted...with blazing temperament...the Philharmonic played with brilliance and spirit..." Taubman, The New York Times  
**MS 6221/ML 5621\***

## yours on Columbia Records



**MUSIC  
SOUNDS BEST  
ON TAPE** — and now  
Ampex has created 2 new,  
low-cost stereo tape players  
devoted exclusively to bringing  
you the bigger-and-better-than-  
ever world of music now  
available on two- and  
four-track stereo  
**TAPE**

**MODEL 934**  
(shown at left-below)  
basic tape player deck  
plays 2- and 4-track stereo  
tapes and monophonic tapes at  
3¾ and 7½ ips — only **\$199.50**  
**MODEL 936** (shown below)  
basic tape deck with built-in,  
pre-amplifier electronics  
for matching ease-  
**\$249.50**

**2 NEW AMPEX PLAYERS**

**2- AND 4-TRACK  
STEREO TAPE**



**Ampex  
\$50  
Award**

offer of  
6 albums of  
4-track  
stereo tape  
with your  
purchase  
expires  
April 30!